

DIGITAL WORKSTATION MONITOR SPEAKER

Tyros3 / TRS-MS02

SERVICE MANUAL



Tyros3



TRS-MS02

CONTENTS

SPECIFICATIONS (Tyros3).....	3	FORMATTING HDD	113
SPECIFICATIONS (TRS-MS02).....	5	SYSTEM RESET	114
PANEL LAYOUT (Tyros3).....	6	OS UPDATE	116
PANEL LAYOUT (TRS-MS02).....	8	INITIALIZING INTERNET SETTINGS.....	118
CIRCUIT BOARD LAYOUT	9	DATA BACKUP	119
DISASSEMBLY PROCEDURE (Tyros3)	11	DISPLAY MESSAGES	120
DISASSEMBLY PROCEDURE (TRS-MS02)	24	SYSTEM BOOTING FLOWCHART	123
INSTALLING THE OPTIONAL DIMMS.....	26	MIDI IMPLEMENTAION CHART	125
REPLACING THE INTERNAL HARD DISK	28	MIDI DATA FORMAT	126
LSI PIN DESCRIPTION.....	30	PARTS LIST	
IC BLOCK DIAGRAM.....	44	BLOCK DIAGRAM	
CIRCUIT BOARDS.....	47	WIRING	
TEST PROGRAM.....	78	OVERALL CIRCUIT DIAGRAM	
INITIAL SETTING	111		

IMPORTANT NOTICE

This manual has been provided for the use of authorized Yamaha Retailers and their service personnel. It has been assumed that basic service procedures inherent to the industry, and more specifically Yamaha Products, are already known and understood by the users, and have therefore not been restated.

WARNING : Failure to follow appropriate service and safety procedures when servicing this product may result in personal injury, destruction of expensive components and failure of the product to perform as specified. For these reasons, we advise all Yamaha product owners that all service required should be performed by an authorized Yamaha Retailer or the appointed service representative.

IMPORTANT : This presentation or sale of this manual to any individual or firm does not constitute authorization certification, recognition of any applicable technical capabilities, or establish a principal-agent relationship of any form.

The data provided is believed to be accurate and applicable to the unit(s) indicated on the cover. The research engineering, and service departments of Yamaha are continually striving to improve Yamaha products. Modifications are, therefore, inevitable and changes in specification are subject to change without notice or obligation to retrofit. Should any discrepancy appear to exist, please contact the distributor's Service Division.

WARNING : Static discharges can destroy expensive components. Discharge any static electricity your body may have accumulated by grounding yourself to the ground bus in the unit (heavy gauge black wires connect to this bus.)

IMPORTANT : Turn the unit **OFF** during disassembly and parts replacement. Recheck **all** work before you apply power to the unit.

WARNING: This product contains chemicals known to the State of California to cause cancer, or birth defects or other reproductive harm. **DO NOT PLACE SOLDER, ELECTRICAL/ELECTRONIC OR PLASTIC COMPONENTS IN YOUR MOUTH FOR ANY REASON WHAT SO EVER!**

Avoid prolonged, unprotected contact between solder and your skin! When soldering, do not inhale solder fumes or expose eyes to solder/flux vapor!

If you come in contact with solder or components located inside the enclosure of this product, wash your hands before handling food.

IMPORTANT NOTICE FOR THE UNITED KINGDOM

Connecting the Plug and Cord

WARNING: THIS APPARATUS MUST BE EARTHED
IMPORTANT. The wires in this mains lead are coloured in accordance with the following code:

GREEN-AND-YELLOW : EARTH
 BLUE : NEUTRAL
 BROWN : LIVE

As the colours of the wires in the mains lead of this apparatus may not correspond with the coloured markings identifying the terminals in your plug proceed as follows:

The wire which is coloured GREEN-and-YELLOW must be connected to the terminal in the plug which is marked by the letter E or by the safety earth symbol ⊕ or colored GREEN or GREEN-and-YELLOW.

The wire which is coloured BLUE must be connected to the terminal which is marked with the letter N or coloured BLACK.

The wire which is coloured BROWN must be connected to the terminal which is marked with the letter L or coloured RED.

• This applies only to products distributed by Yamaha-Kemble Music (U.K.) Ltd. (3 wires)

WARNING

Components having special characteristics are marked



and must be replaced with parts having specification equal to those originally installed.

SAVING DATA



Be sure to perform it

Saving and backing up your data

• The data of the types listed below are lost when you turn off the power to the instrument. Save the data to the User drive or appropriate external media.

- Created/Edited Voices
- Created/Edited Styles
- Memorized One Touch Settings
- Recorded/Edited Songs
- Created Multi Pads
- Edited MIDI Settings

Data in the User drive may be lost due to malfunction or incorrect operation. Save important data to an external media.

Data in the internal hard disk drive may be lost due to malfunction or incorrect operation. We recommend that you backup any necessary data to computer by using the USB Storage Mode.

Backing up the USB storage device/external media

• To protect against data loss through media damage, we recommend that you save your important data onto two USB storage devices/external media.

■ SPECIFICATIONS (Tyros3)

Keyboard	Keys	61 keys (C1–C6) Initial Touch/Aftertouch
	Type	Organ (FSX)
Voice	Polyphony (max)	128
	Layer	R1/R2/R3/L
	Split	Style (default point: F#2), Left (default point: F#2), Right 3 (default point: G2)
	Voices	749 Voices + 20 Organ Flutes + 480 XG Voices + 256 GM2 Voice + 35 Drum/SFX kits (And GS Voices for GS Song playback)
	MegaVoice	23
	S.Articulation2! (AEM technology)	11 [TRUMPET] JazzTrumpet / ClassicTrumpet [SAXOPHONE] JazzSax / Breathysax [FLUTE/CLARINET] Clarinet / BalladClarinet / RomanceClarinet / IrishPipeAir / IrishPipeDance [ACCORDION] Harmonica / BluesHarp
	S.Articulation!	53
	Sweet!	26
	Cool!	58
	Live!	70
	Live! Drums	12 (Included Live! SFX)
Organ Flutes!	20 Presets	
Voice Expandability	Custom Voices	Yes (Wave Addition: Normal Voices, Drum Voices)
	Premium Voices	Yes (optional DIMM memory is necessary)
	Voice Set	Yes
Style	Styles	450
	Format	SFF GE
	Control	SYNC STOP, SYNC START, START/STOP, AUTO FILL IN
	Section	Intro x 3, Ending x 3, Main x 4, Fill In x 4, Break
	Fingering	Single Finger, Fingered, Fingered On Bass, Multi Finger, AI Fingered, Full Keyboard, AI Full Keyboard
	Style Creator	Yes
	RAM Capacity per a Style	approx. 120 KB
OTS (One Touch Setting)		4 for each Style
Music Finder	Preset Records	1850
	Music Finder Plus	Yes
Song	Preset Songs	5 Sample Songs
	Control	REC, STOP, PLAY/PAUSE, REW, FF, METRONOME
	Recording	Quick Recording, Multi Recording, Step Recording
	Tracks	16
	RAM Capacity per a Song	approx. 300 KB
	Lyric Display	Yes
	Score Display	Yes
	Song Position Jump	4 point / Loop
Style/Song Control		FADE IN/OUT, TAP TEMPO, TEMPO (5–500)
Data Compatibility		GM, XG, XF, SFF, SFF GE, GM2/GS (for Song Playback)
Hard Disk Recorder	Tracks	Play: 2 Stereo Track REC: 1 Stereo Track
	Control	REC, STOP, PLAY/PAUSE, PREV, NEXT, SELECT, SETTING
	File Format	Wave (16-bit, 44.1 kHz, stereo)
MultiPad	Preset	123 banks x 4 Pads
	Control	Pad 1–4, SELECT, STOP, SYNC START
Vocal Harmony		60 Preset + 10 user

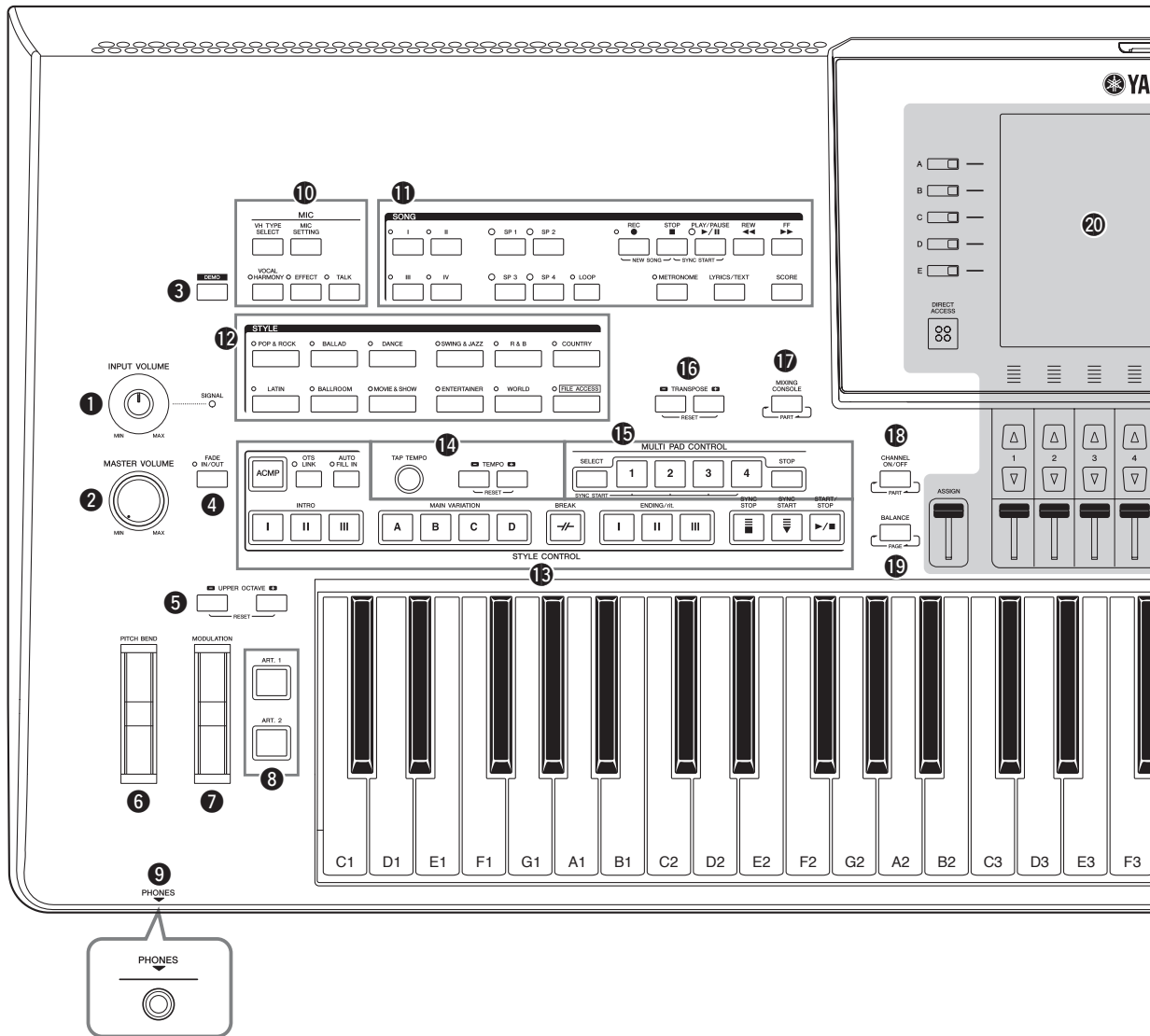
Effects	Reverb	42	
	Chorus	106	
	DSP1–DSP7	272	
	DSP8–DSP9	272 (for Style)	
	Master Compressor	5 presets + 5 user settings	
	Master Equalizer	5 presets + 2 user settings	
	Harmony/Echo	Yes	
	Sustain Button	Yes	
Registration Memory	Buttons	1–8	
	Control	Bank select, Memory, Freeze, Registration Sequence	
Control	Pitch Bend Wheel	Yes	
	Modulation Wheel	Yes	
	Articulation Switch	ART. 1, ART. 2	
	Sliders	9 (including 1 assignable)	
Transpose		-12–0–12 (Keyboard/Song/Master)	
Tuning		414.8–440–466.8 Hz	
Display		640 x 480 dots TFT VGA color 7.5 inch LCD	
	Language	5 languages (English, German, French, Spanish, Italian)	
	Text Viewer	Yes	
	Wallpaper Customize	Yes	
Storage		USB to Device	
	Internal Flash	3.2MB	
	Hard Disk (installable)	Yes	
Terminals	USB TO HOST	USB 2.0 HighSpeed x 1	
	USB TO DEVICE	USB 2.0 HighSpeed x 2 (Front/Back)	
	MIDI	MIDI A (IN/OUT), MIDI B (IN/OUT)	
	FOOT PEDAL	1 (SUSTAIN), 2 (ARTICULATION 1), 3 (VOLUME), Function Assignable	
	Audio		LINE OUT MAIN (L/L+R, R)
			LINE OUT SUB (1, 2)
			LOOP SEND (L/L+R, R) / AUX OUT (Level Fixed): Selectable
			LOOP RETURN (L/L+R, R) / AUX IN (with TRIM control)
			MIC/LINE IN (with TRIM control)
			PHONES
	RGB OUT	Yes	
	VIDEO OUT	NTSC / PAL Composit	
	LAN	Yes (Internet Direct Connection)	
For Option Speaker	To Satellite Speaker (L/R), To Sub Woofer (L/R)		
Power Supply	AC IN		
Dimensions [W x D x H] (without Music Rest)		1140 x 450 x 143 mm	
Weight (without Music Rest)		15 kg	
Included Accessories		AC power cord, Music rest and brackets, CD-ROM, Owner's Manual, Installation Guide, User Registration Card	
Optional Accessories	Speaker	TRS-MS02	
	Headphones	HPE-150	
	Footswitch	FC4/FC5	
	Foot Controller	FC7	
	MIDI Foot Controller	MFC10	
	Floppy Disk Drive	UD-FD01	
	Keyboard Stand	L-7S	

■ SPECIFICATIONS (TRS-MS02)

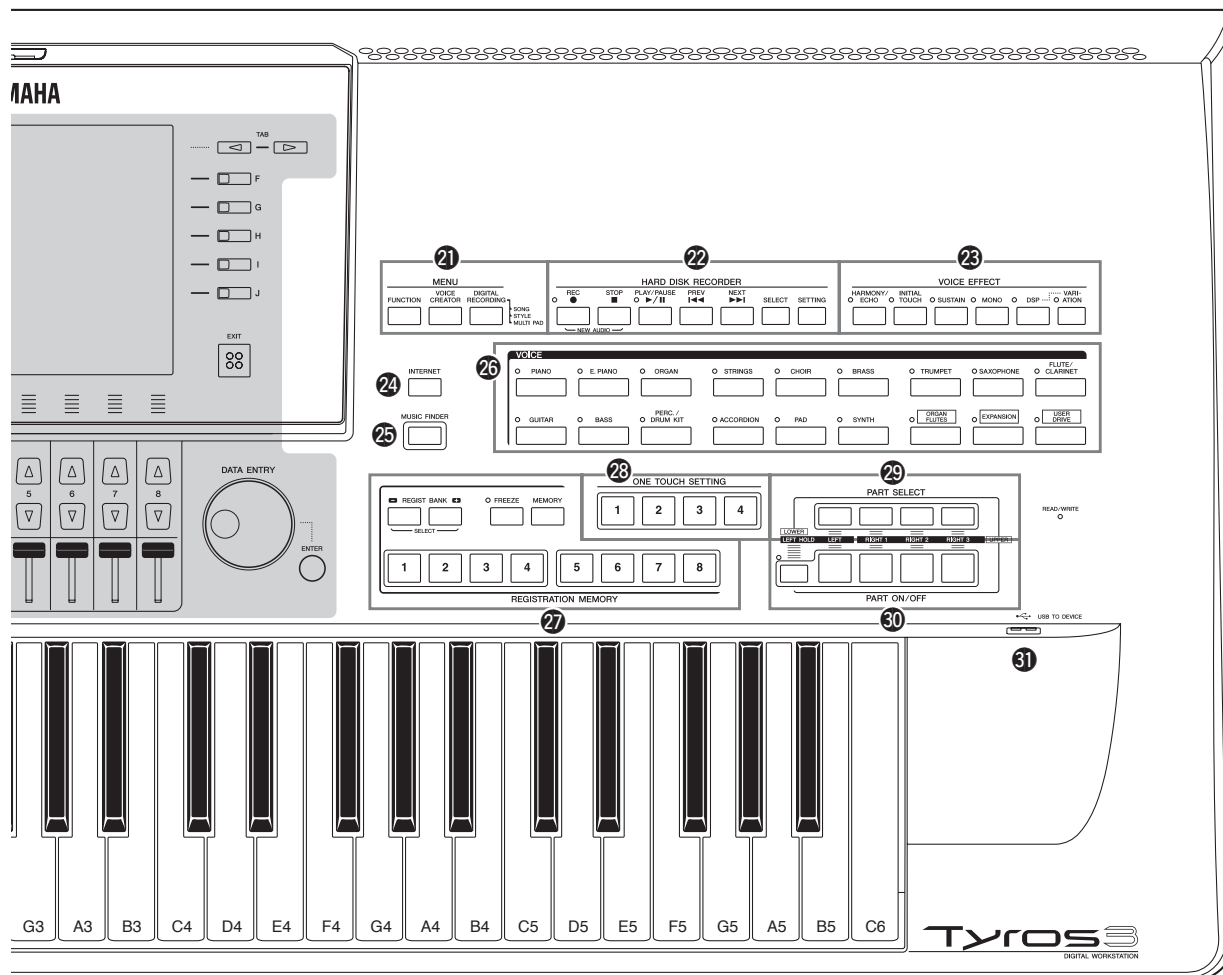
Type	Advanced Active Servo Technology
Output power	Satellite speakers..... 20 W + 20 W (1 kHz, 4 Ω at T.H.D.=10%) Subwoofer..... 40 W (100 Hz, 5 Ω at T.H.D.=10%)
Frequency response	32 Hz to 20 kHz
Speaker unit	Satellite speakers Tweeter..... 1.9 cm (3/4") dome, magnetic shielding Midrange..... 8 cm (3") cone, magnetic shielding Subwoofer..... 16 cm (6.5") cone, magnetic shielding
Power consumption	65W
Power supply	U.S.A. and Canada models.....AC 120 V, 60 Hz Australia model.....AC 240 V, 50 Hz U.K. and Europe models.....AC 230 V, 50 Hz
Dimensions (W x H x D)	Satellite speakers..... 97 (3.8") x 174 (6.9") x 178 (7")mm Subwoofer..... 350 (13.8") x 210 (8.3") x 321 (12.6") mm
Weight	Satellite speakers..... 0.7 kg (1 lb. 9 oz.) x 2 Subwoofer..... 8.0 kg (17 lbs. 10 oz.)
Accessories	Speaker brackets x 2, RCA pin cables x 2, RCA pin/8-pin combination cable x 1

PANEL LAYOUT (Tyros3)

• Top Panel

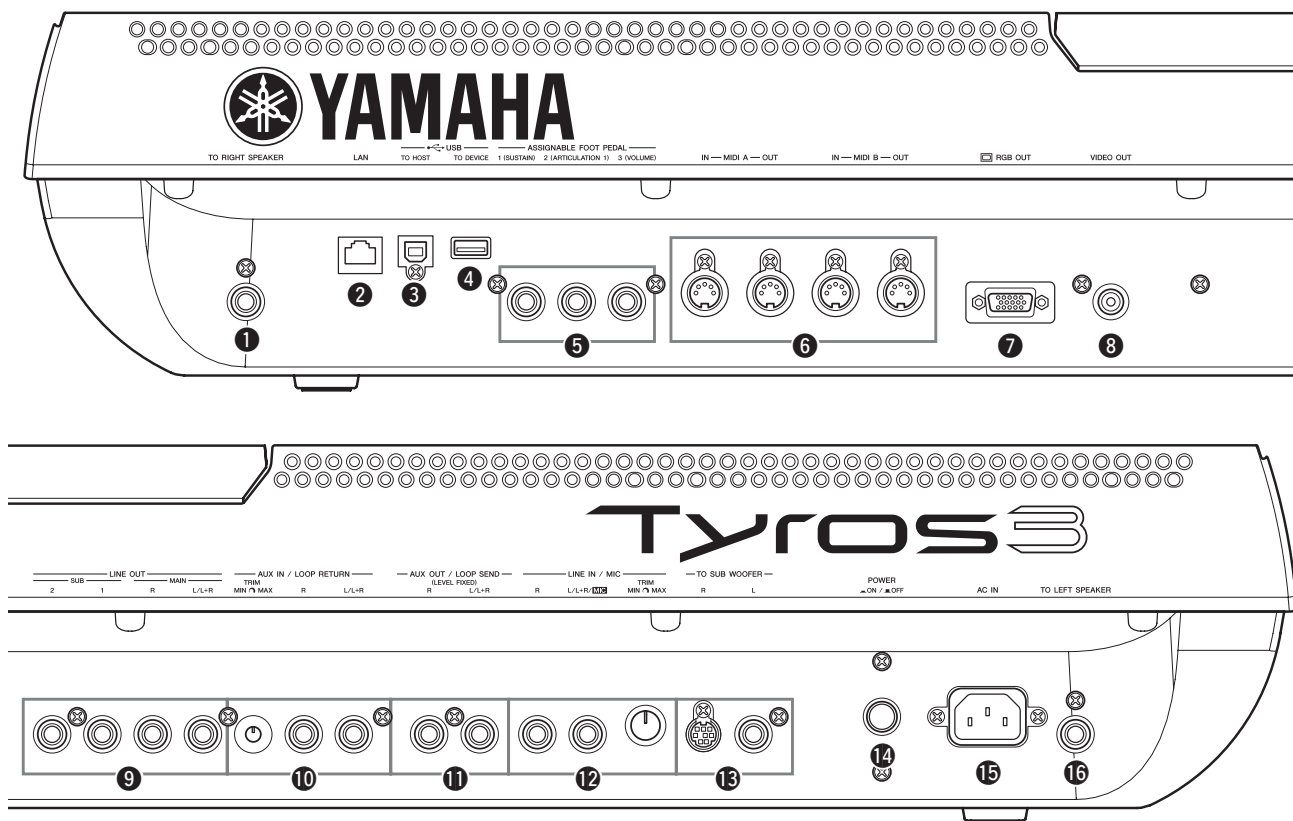


- | | |
|---|---|
| <ul style="list-style-type: none"> ① [INPUT VOLUME] control ② [MASTER VOLUME] control ③ [DEMO] button ④ [FADE IN/OUT] button ⑤ [UPPER OCTAVE] buttons ⑥ [PITCH BEND] wheel ⑦ [MODULATION] wheel ⑧ [ART. 1/ART. 2] buttons ⑨ [PHONES] jack ⑩ [MIC] buttons | <ul style="list-style-type: none"> ⑪ [SONG] buttons ⑫ [STYLE] category selection buttons ⑬ [STYLE CONTROL] buttons ⑭ [TEMPO] buttons ⑮ [MULTI PAD CONTROL] buttons ⑯ [TRANPOSE] buttons ⑰ [MIXING CONSOLE] button ⑱ [CHANNEL ON/OFF] button ⑲ [BALANCE] button ⑳ LCD and related controls |
|---|---|



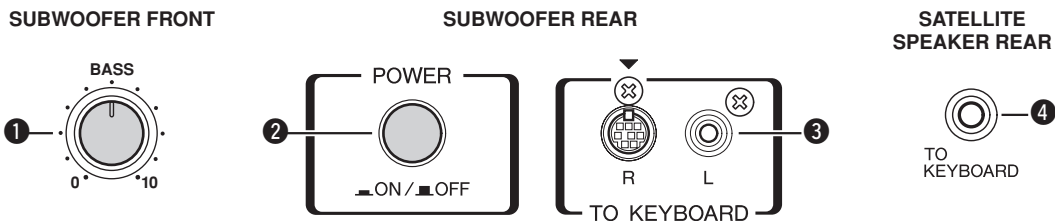
- 21 [MENU] buttons
- 22 [HARD DISK RECORDER] buttons
- 23 [VOICE EFFECT] buttons
- 24 [INTERNET] button
- 25 [MUSIC FINDER] button
- 26 [VOICE] category selection buttons
- 27 [REGISTRATION MEMORY] buttons
- 28 [ONE TOUCH SETTING] buttons
- 29 [PART SELECT] buttons
- 30 [PART ON/OFF] buttons
- 31 [USB TO DEVICE] terminal

• Rear Panel



- ① [TO RIGHT SPEAKER] jack
- ② [LAN] terminal
- ③ [USB TO HOST] terminal
- ④ [USB TO DEVICE] terminal
- ⑤ [ASSIGNABLE FOOT PEDAL] jacks
- ⑥ [MIDI] terminals
- ⑦ [RGB OUT] terminal
- ⑧ [VIDEO OUT] terminal
- ⑨ [LINE OUT] jacks
- ⑩ [AUX IN/LOOP RETURN] jacks
- ⑪ [AUX OUT/LOOP SEND] jacks
- ⑫ [LINE IN/MIC] jacks
- ⑬ [TO SUB WOOFER] jacks
- ⑭ [POWER ON/OFF] switch
- ⑮ [AC IN] terminal
- ⑯ [TO LEFT SPEAKER] jack

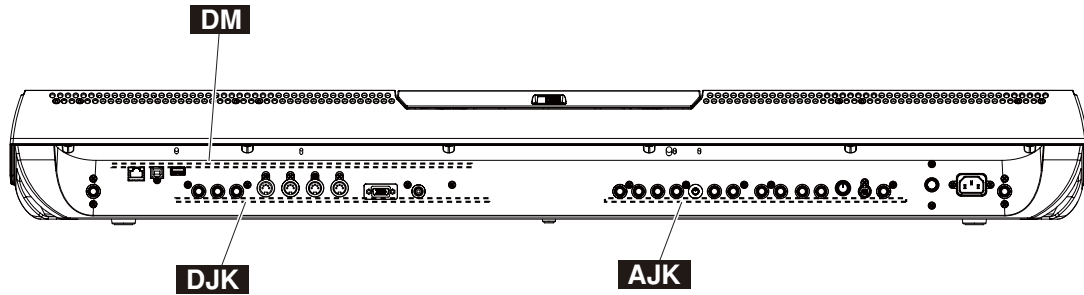
■ PANEL LAYOUT (TRS-MS02)



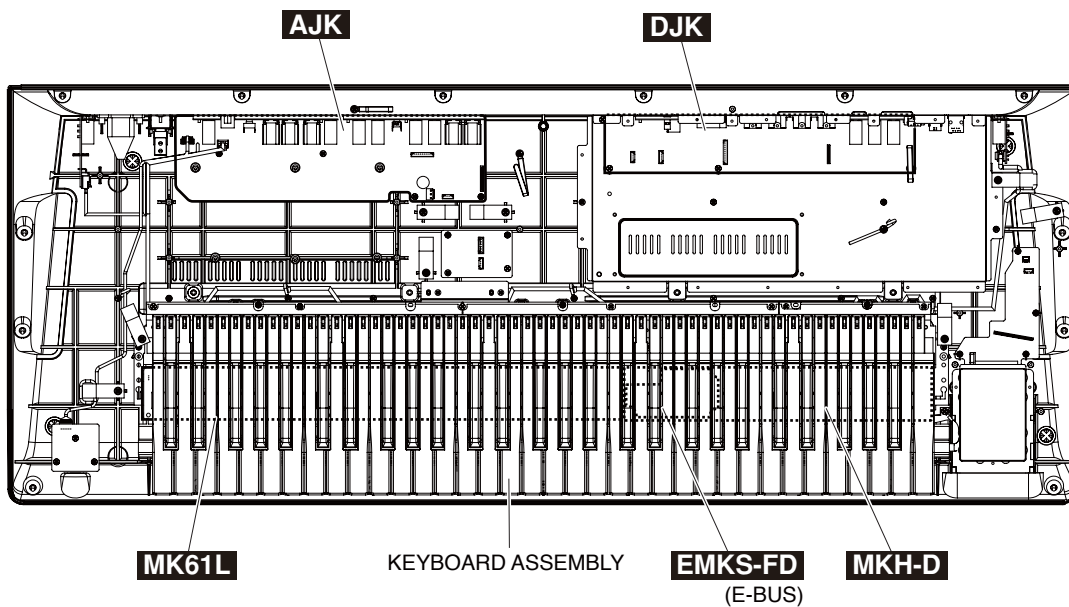
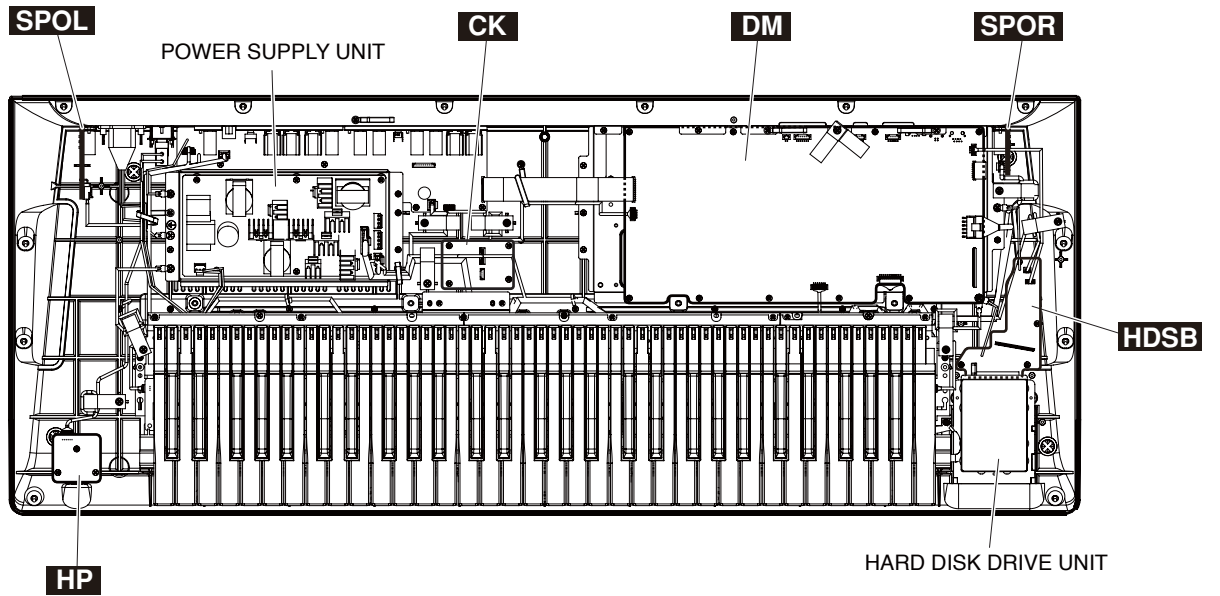
- ① [BASS] control knob
- ② Main [POWER] switch
- ③ [TO KEYBOARD L,R] jacks (WOOFER)
- ④ [TO KEYBOARD] jack (Satellite)

CIRCUIT BOARD LAYOUT

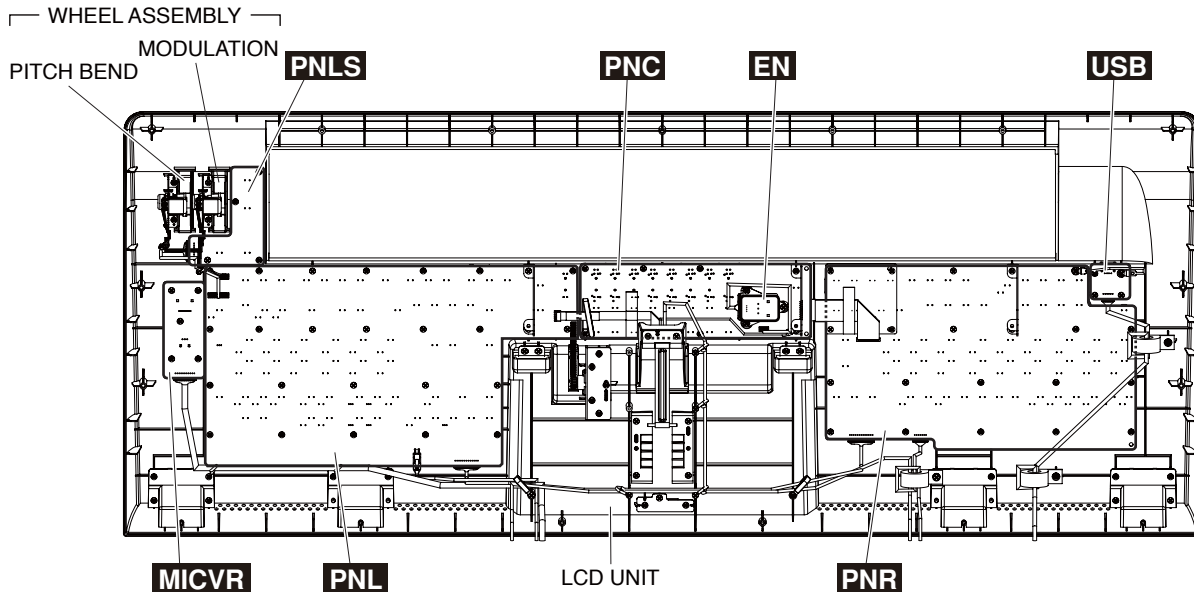
• Rear Side



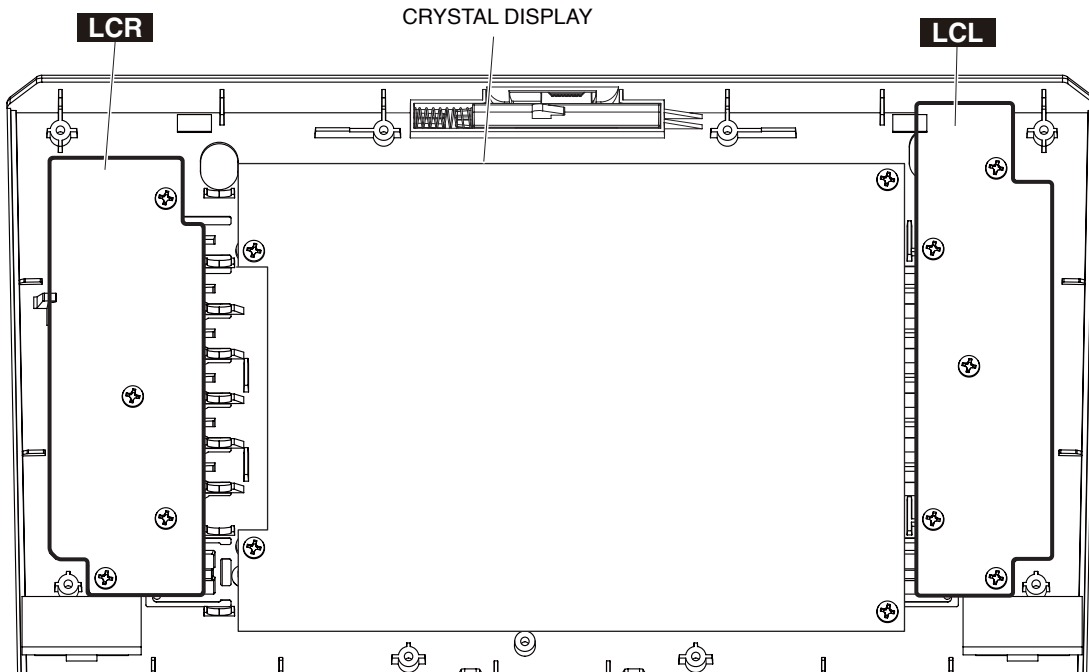
• Lower Case Side



• Upper Case Side



• LCD Unit



DISASSEMBLY PROCEDURE (Tyros3)

Precautions

- If you want to turn the instrument or upper case unit upside down, prepare supporting materials and put the both end portions of the instrument or upper case unit on the supporting materials. (Fig. A)
- During reassembly, reinstall the adhesive tape, cord holder, GND wire and ferrite core that were removed during disassembly as they were before removal.

- Notes on Flat Cable
When connecting to the connector, pay attention not to insert the cable inversely. (Photo A)

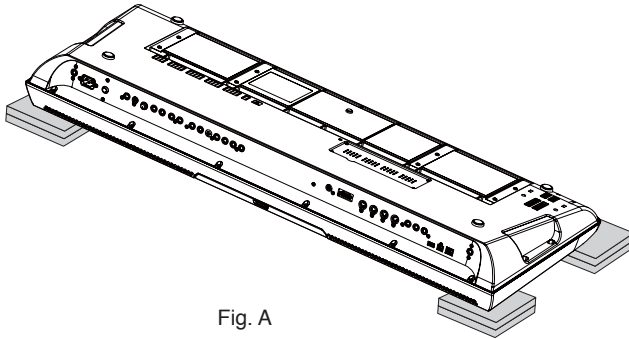
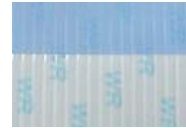


Fig. A



Front Side



Back Side

Photo A

1.	Separation of Upper Case Unit and Lower Case Unit.....	12
2.	DM Circuit Board.....	13
3.	DJK Circuit Board.....	14
4.	AC Upper Frame Assembly.....	14
5.	Power Supply Unit.....	14
6.	AC Lower Frame Assembly.....	14
7.	AJK Circuit Board.....	15
8.	ACIN Wiring Assembly.....	15
9.	SPOL Circuit Board, SPOR Circuit Board.....	15
10.	CK Circuit Board.....	15
11.	HP Circuit Board.....	15
12.	HDSB Circuit Board.....	15
13.	PNL Circuit Board.....	16
14.	EN Circuit Board.....	16
15.	PNC Circuit Board.....	16
16.	PNR Circuit Board.....	16
17.	PNLS Circuit Board.....	17
18.	MICVR Circuit Board.....	17
19.	USB Circuit Board.....	17
20.	Wheel Assembly (PITCH BEND, MODULATION).....	17
21.	LCD Unit.....	17
22.	LCD Lower Assembly and Gear.....	18
23.	LCL Circuit Board.....	18
24.	LCR Circuit Board.....	18
25.	Crystal Display.....	19
26.	Keyboard Assembly.....	19
27.	Keys (White and Black Keys).....	20
28.	Installing Keys (Black and White Keys).....	21
29.	Disassembling Keyboard Assembly.....	21
29-1	Rubber Contact.....	21
29-2	MK61L Circuit Board.....	22
29-3	MKH-D Circuit Board, EMKS-FD Circuit Board.....	22
30.	Hard Disk Drive Unit.....	23

1. Separation of Upper Case Unit and Lower Case Unit

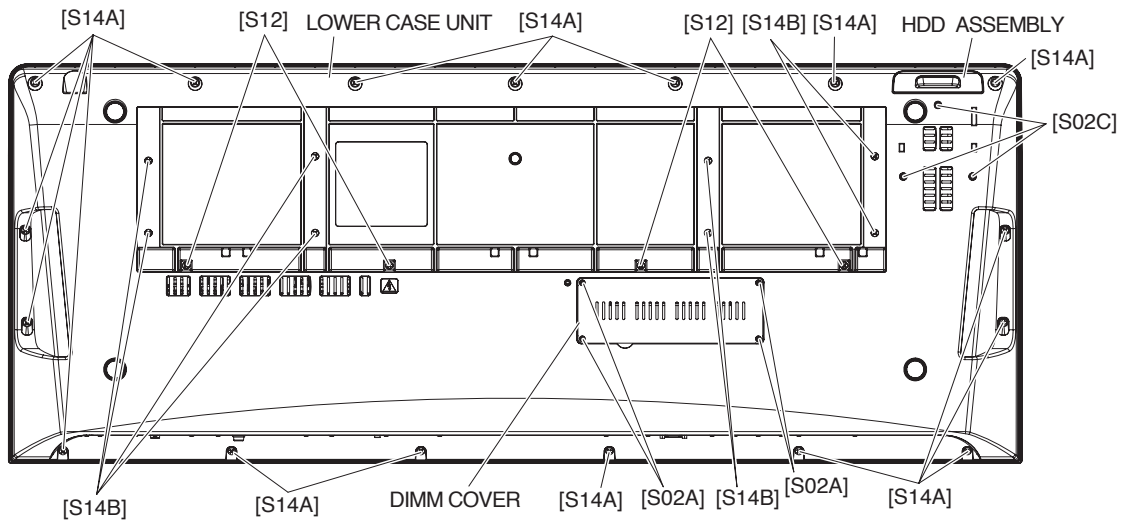
(The required: About 5 minutes).

- 1-1 Remove the four (4) screws marked [S12] and seventeen (17) screws marked [S14A], lift the rear side of the upper case unit a little, pull it toward you a little paying attention not to damage connector assemblies, and lift the upper case unit carefully. (Fig. 1, Photo 1)
- 1-2 Remove the six (6) screws marked [S03A]. The ACDM earth angle can then be removed. (Fig. 2)
- 1-3 Remove the screw marked [S09]. (Fig. 2)
- 1-4 Disconnect all the connector assemblies connecting the upper case unit and lower case unit. The upper case unit and lower case unit can then be separated.

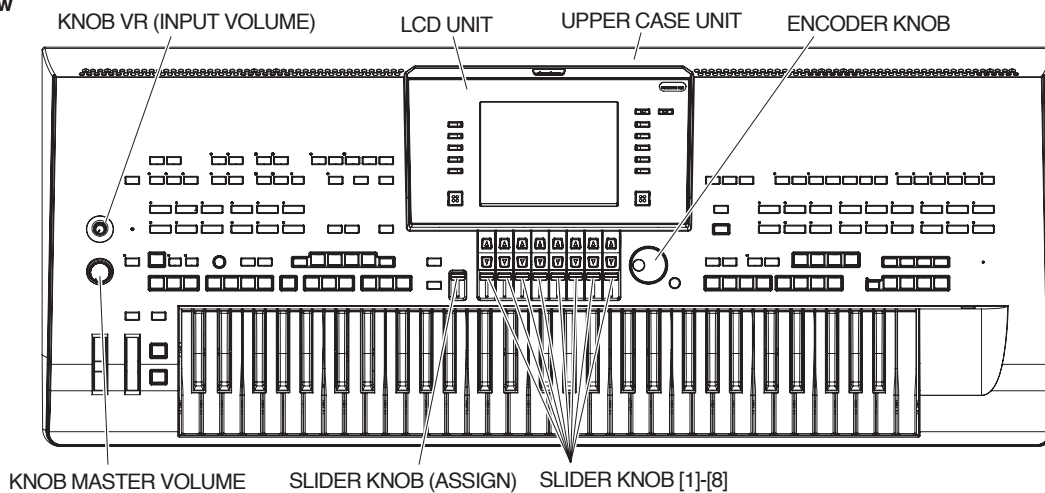


Photo 1

• Bottom View



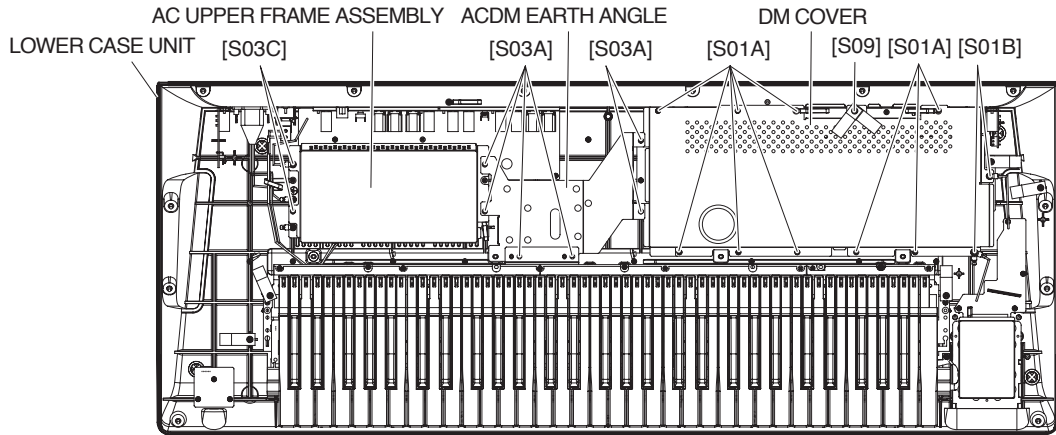
• Top View



- [S02]: BIND HEAD SCREW 3.0X8 MFZN2B3 (WE983600)
- [S12]: BIND HEAD SCREW 4.0X10 MFZN2W3 (WE96650R)
- [S14]: BIND HEAD TAPPING SCREW-B 4.0X16 MFZN2W3 (WF15410R)

Fig. 1

• Top View



- [S01]: BIND HEAD SCREW 3.0X6 MFZN2W3 (WE774000)
- [S03]: BIND HEAD TAPPING SCREW-B 3.0X8 MFZN2W3 (WE774301)
- [S09]: PW HEAD MACHINE SCREW 3.0 X 12 MFZN2W3 (WP817100)

Fig. 2

2. DM Circuit Board

(Time Required: About 8 minutes)

* If there is a DIMM inserted into the DIMM socket, remove the four (4) screws marked [S02A], DIMM cover and the DIMM before going to the procedures below. (Fig1, Fig. 3)

* MAC (Media Access Control) address is stored in the DM circuit board. If the DM circuit board is replaced, MAC address will be changed.

- 2-1 Separate the upper case unit and lower case unit. (See procedure 1.)
- 2-2 Remove the nine (9) screws marked [S01A] and two (2) screws marked [S01B]. The DM cover can then be removed. (Fig. 2)
- 2-3 Remove the four (4) screws marked [S01C] and the screw marked [S02B]. The DM circuit board can then be removed. (Fig. 4)

• Removing DIMMs

Press the ejector levers until the DIMM unlocks.

Pull the DIMM vertically out of the socket.

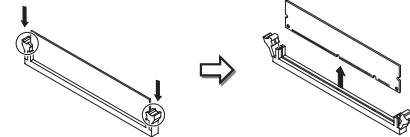
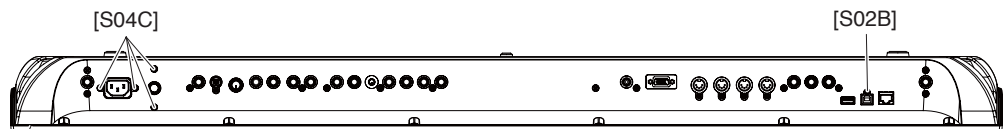
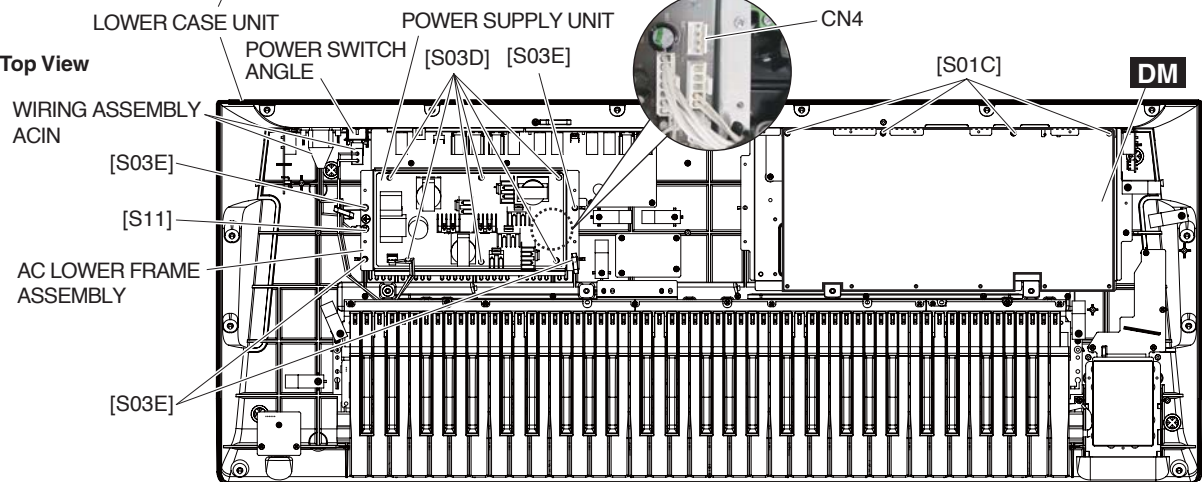


Fig. 3

• Rear View



• Top View



- [S01B]: BIND HEAD SCREW 3.0X6 MFZN2W3 (WE774000)
- [S02B]: BIND HEAD SCREW 3.0X8 MFZN2B3 (WE983600)
- [S03]: BIND HEAD TAPPING SCREW-B 3.0X8 MFZN2W3 (WE774301)
- [S04C]: BIND HEAD TAPPING SCREW-B 3.0X10 MFZN2B3 (WE972200)
- [S11]: BIND HEAD SCREW 4.0X8 MFZN2W3 (WE968500)

Fig. 4

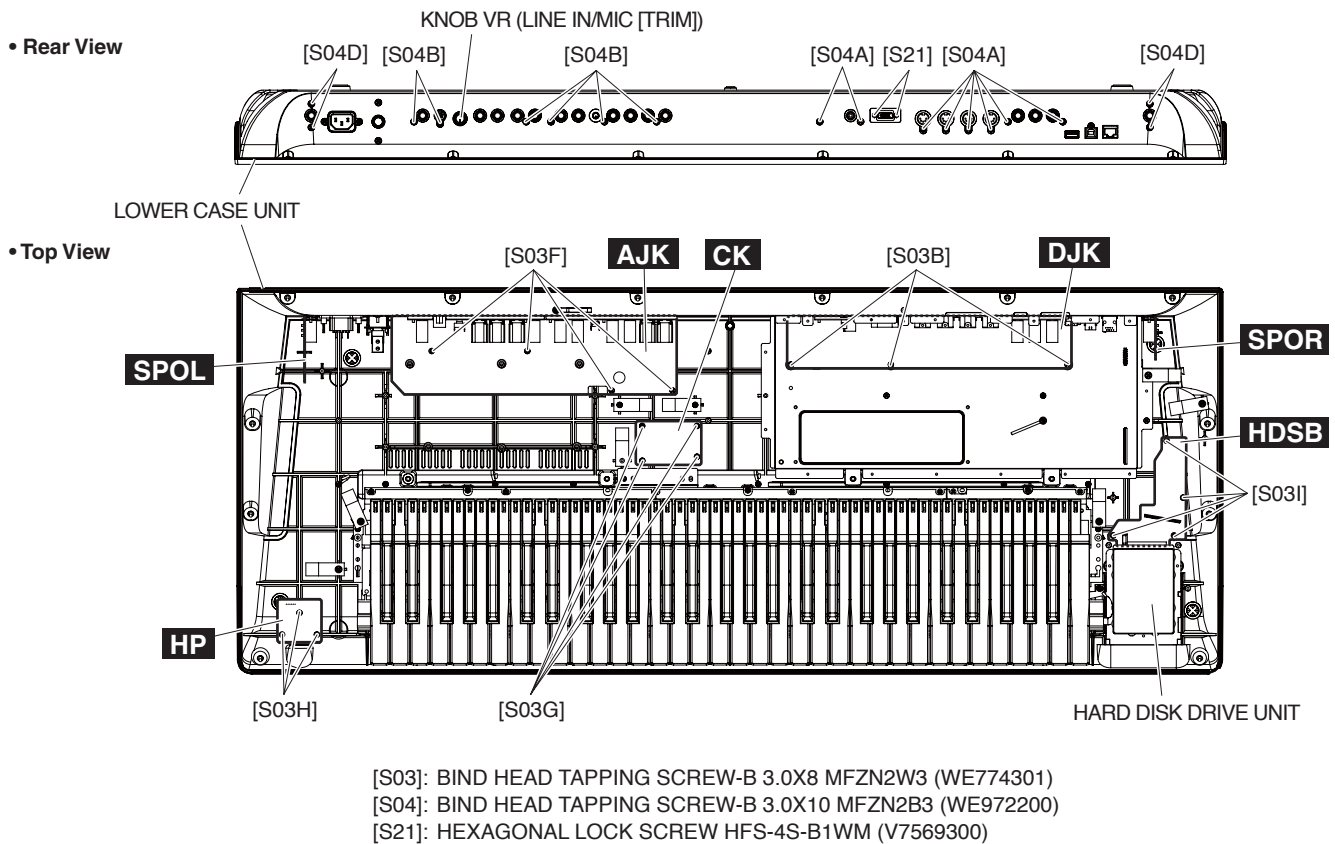


Fig. 5

3. DJK Circuit Board

(Time Required: About 10 minutes)

- 3-1 Separate the upper case unit and lower case unit. (See procedure 1.)
- 3-2 Remove the DM circuit board. (See procedure 2.)
- 3-3 Remove the three (3) screws marked [S03B], eight (8) screws marked [S04A] and two (2) hexagonal lock screws marked [S21]. The DJK circuit board can then be removed. (Fig. 5)

4. AC Upper Frame Assembly

(Time Required: about 6 minutes)

- 4-1 Separate the upper case unit and lower case unit. (See procedure 1.)
- 4-2 Remove the two (2) screws marked [S03C]. The AC upper frame assembly can then be removed. (Fig. 2)

5. Power Supply Unit

(Time Required: About 7 minutes)

- 5-1 Separate the upper case unit and lower case unit. (See procedure 1.)
- 5-2 Remove the AC upper frame assembly. (See procedure 4.)
- 5-3 Remove the six (6) screws marked [S03D]. The power supply unit can then be removed. (Fig. 4)
- * **No cord should be connected to the CN4 of the power supply unit. Pay attention to connection during installment. (Fig. 4)**

6. AC Lower Frame Assembly

(Time Required: about 7 minutes)

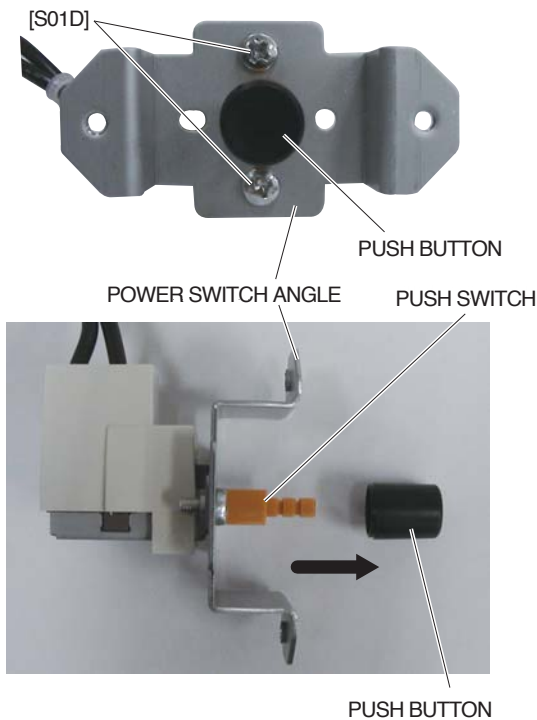
- 6-1 Separate the upper case unit and lower case unit. (See procedure 1.)
- 6-2 Remove the AC upper frame assembly. (See procedure 4.)
- 6-3 Remove the two (4) screws marked [S03E] and the screw marked [S11]. The AC lower frame assembly can then be removed with the power supply unit on it. (Fig. 4)
- * **No cord should be connected to the CN4 of the power supply unit. Pay attention to connection during installment. (Fig. 4)**

**7. AJK Circuit Board
(Time Required: About 8 minutes)**

- 7-1 Separate the upper case unit and lower case unit. (See procedure 1.)
- 7-2 Remove the AC upper frame assembly. (See procedure 4.)
- 7-3 Remove the AC lower frame assembly with the power supply unit on it (See procedure 6.)
- 7-4 Remove the VR knob (LINE IN/MIC [TRIM]). (Fig. 5)
- 7-5 Remove the four (4) screws marked [S03F] and six (6) screws marked [S04B]. The AJK circuit board can then be removed. (Fig. 5)

**8. ACIN Wiring Assembly
(Time Required: About 7 minutes)**

- 8-1 Separate the upper case unit and lower case unit. (See procedure 1.)
 - 8-2 Remove the AC upper frame assembly. (See procedure 4.)
 - 8-3 Remove the four (4) screws marked [S04C] and the screw marked [S11]. The ACIN wiring assembly can then be removed together with the power switch angle. (Fig. 4)
 - 8-4 Remove the two (2) screws marked [S01D]. The power switch angle can then be removed. (Photo 2)
- * **The push button is not part of the ACIN wiring assembly. When replacing the ACIN wiring assembly (push switch), remove the push button from the push switch of the ACIN wiring assembly and install it on the new ACIN wiring assembly. (Photo 2)**



[S01]: BIND HEAD SCREW 3.0X6 MFZN2W3 (WE774000)

Photo 2

**9. SPOL Circuit Board, SPOR Circuit Board
(Time Required: About 6 minutes)**

- 9-1 Separate the upper case unit and lower case unit. (See procedure 1.)
 - 9-2 Remove the two (2) screws marked [S04D]. The SPOL circuit board can then be removed. (Fig. 5)
- * **The SPOR circuit board can be removed in the same way.**

**10. CK Circuit Board
(Time Required: About 6 minutes)**

- 10-1 Separate the upper case unit and lower case unit. (See procedure 1.)
- 10-2 Remove the four (4) screws marked [S03G]. The CK circuit board can then be removed. (Fig. 5)

**11. HP Circuit Board
(Time Required: About 6 minutes)**

- 11-1 Separate the upper case unit and lower case unit. (See procedure 1.)
- 11-2 Remove the three (3) screws marked [S03H]. The HP circuit board can then be removed. (Fig. 5)

**12. HDSB Circuit Board
(Time Required: About 6 minutes)**

- 12-1 Separate the upper case unit and lower case unit. (See procedure 1.)
- 12-2 Remove the two (2) screws marked [S01B] and four (4) screws marked [S03I]. (Fig. 2, Fig. 5)
- 12-3 Pull off the HDSB circuit board from the HDD terminal. (Photo 3)

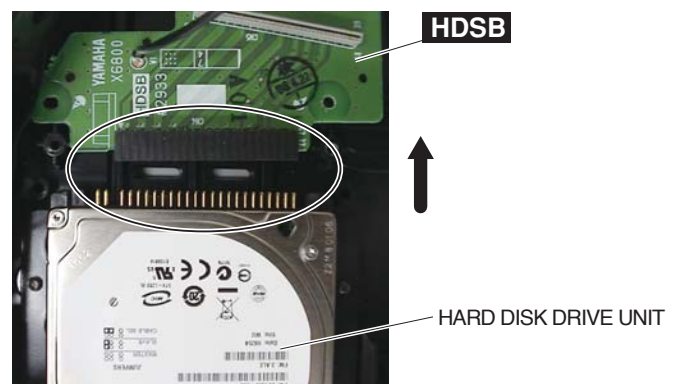
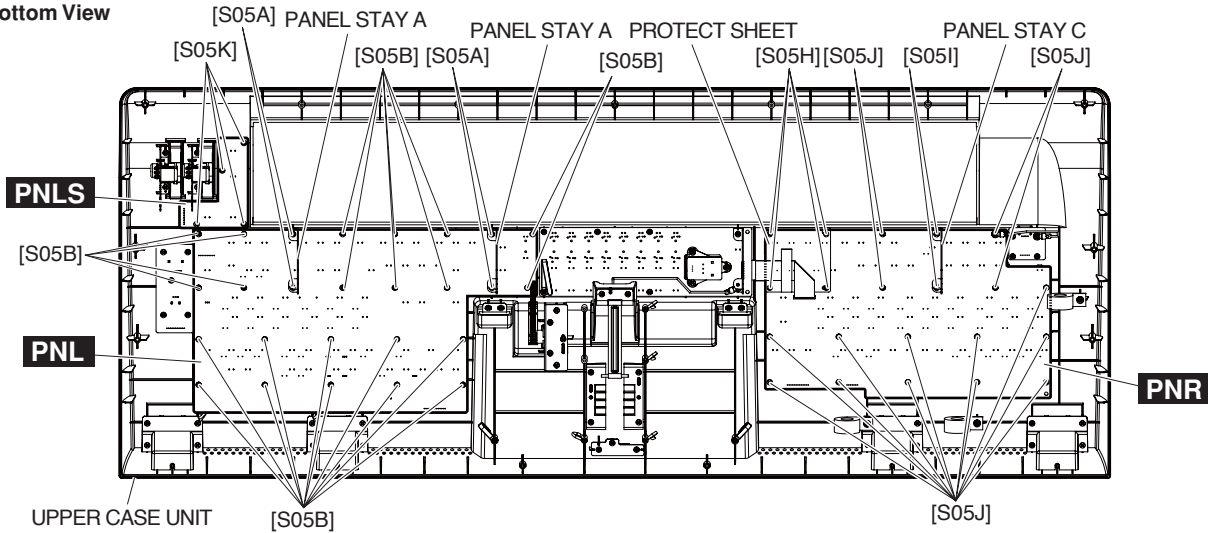


Photo 3

• Bottom View



[S05]: BIND HEAD TAPPING SCREW-B 3.0X10 MFZN2W3 (WE774200)

Fig. 6

13. PNL Circuit Board

(Time Required: About 10 minutes)

- 13-1 Remove the slider knob (ASSIGN) from the control panel. (Fig. 1)
- 13-2 Separate the upper case unit and lower case unit. (See procedure 1.)
- 13-3 Remove the four (4) screws marked [S05A]. The two (2) panel stays A can then be removed. (Fig. 6)
- 13-4 Remove the twenty-two (22) screws marked [S05B]. The PNL circuit board can then be removed. (Fig. 6)

14. EN Circuit Board

(Time Required: About 6 minutes)

- 14-1 Remove the encoder knob from the control panel (Fig. 1, Fig. 7).
- 14-2 Separate the upper case unit and lower case unit. (See procedure 1.)
- 14-3 Remove the three (3) screws marked [S05C]. The ENC assembly can then be removed. (Fig. 9)
- 14-4 Remove the hexagonal nut marked [A] and the washer marked [B]. The ENC stay can then be removed. (Fig. 8)

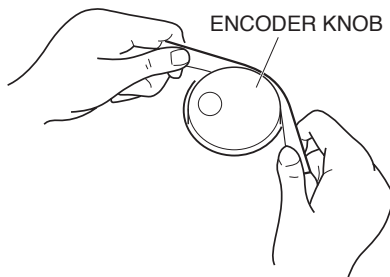


Fig. 7

15. PNC Circuit Board

(Time Required: About 8 minutes)

- 15-1 Remove the eight (8) slider knobs (ASSIGN) and the encoder knob from the control panel. (Fig. 1)
- 15-2 Separate the upper case unit and lower case unit. (See procedure 1.)
- 15-3 Remove the ENC assembly. (See procedure 14-3)
- 15-4 Release the lock at the back of the LCD unit, open the LCD unit and remove the screw marked [S05D] which has been hidden. (Fig. 9, 10)
- 15-5 Remove the five (5) screws marked [S05E], the screw marked [S05F], the screw marked [S05G] and the panel stay B. The PNC circuit board can then be removed. (Fig. 9)

16. PNR Circuit Board

(Time Required: About 9 minutes)

- 16-1 Separate the upper case unit and lower case unit. (See procedure 1.)
- 16-2 Remove the four (4) screws marked [S05H] and the protect sheet. (Fig. 6)
- 16-3 Remove the two (2) screws marked [S05I]. The panel stay C can then be removed. (Fig. 6)
- 16-4 Remove the fifteen (15) screws marked [S05J]. The PNR circuit board can then be removed. (Fig. 6)

• ENC Ass'y

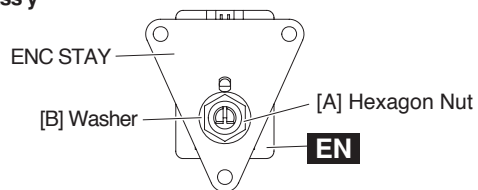


Fig. 8

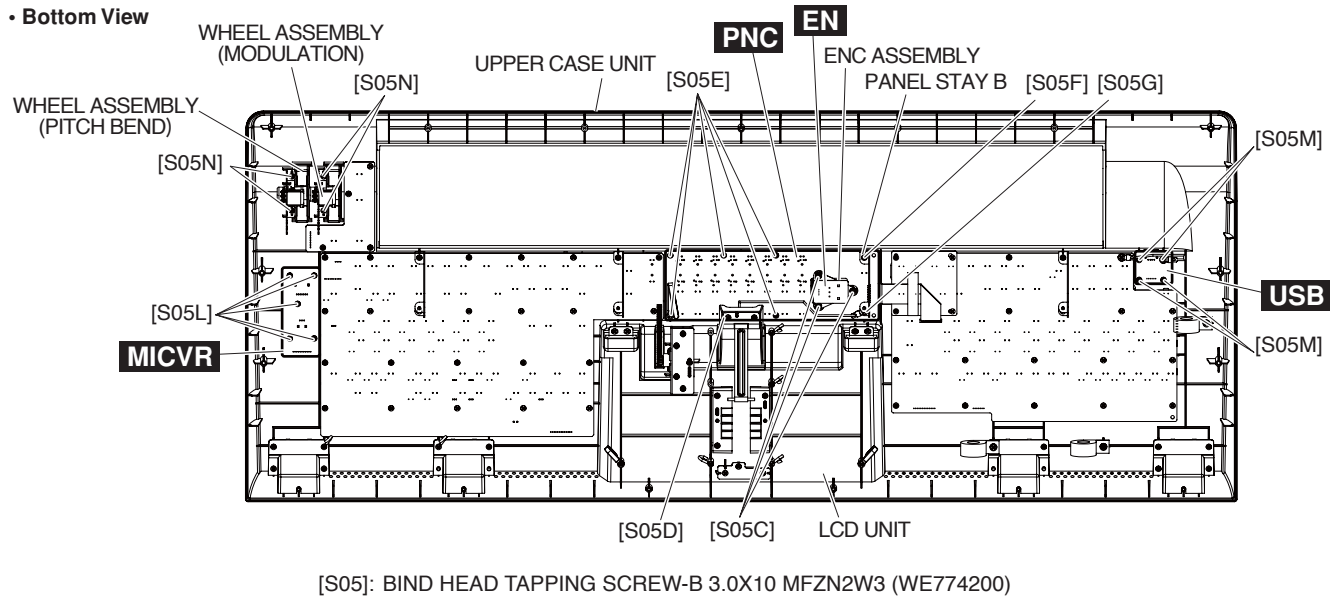


Fig. 9

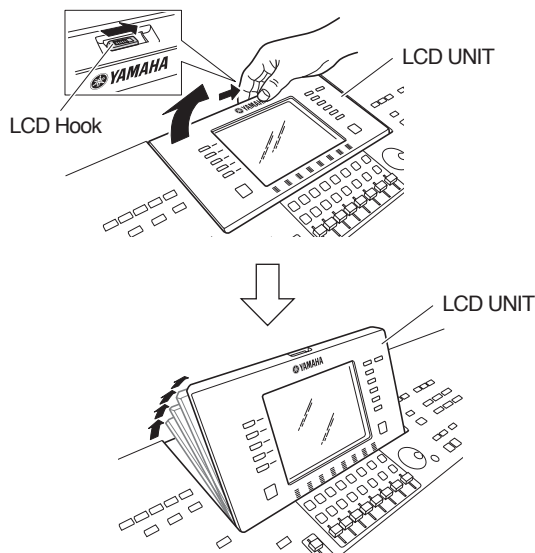


Fig. 10

17. PNLS Circuit Board (Time Required: About 6 minutes)

- 17-1 Separate the upper case unit and lower case unit. (See procedure 1.)
- 17-2 Remove the four (4) screws marked [S05K]. The PNLS circuit board can then be removed. (Fig. 6)

18. MICVR Circuit Board (Time Required: About 6 minutes)

- 18-1 Remove the VR knob (INPUT VOLUME) and the MASTER VOLUME knob from the control panel. (Fig. 1)
- 18-2 Separate the upper case unit and lower case unit. (See procedure 1.)
- 18-3 Remove the five (5) screws marked [S05L]. The MICVR circuit board can then be removed. (Fig. 9)

19. USB Circuit Board (Time Required: About 6 minutes)

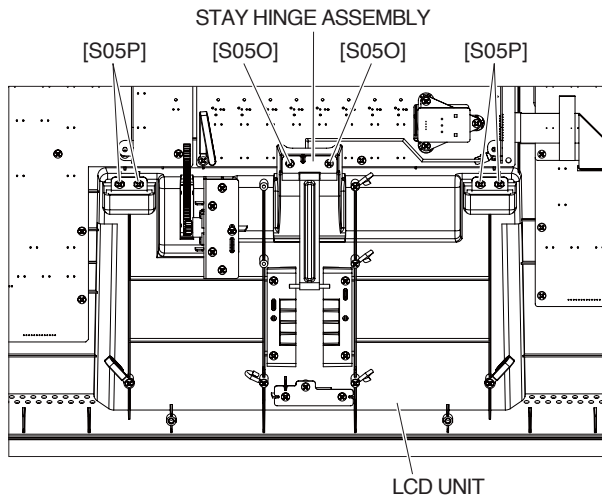
- 19-1 Separate the upper case unit and lower case unit. (See procedure 1.)
- 19-2 Remove the four (4) screws marked [S05M]. The USB circuit board can then be removed. (Fig. 9)

20. Wheel Assembly (PITCH BEND, MODULATION) (Time Required: About 6 minutes)

- 20-1 Separate the upper case unit and lower case unit (See procedure 1).
- 20-2 Remove the two (2) screws marked [S05N]. The wheel assembly (PITCH BEND) can then be removed. (Fig. 9)
- * **The wheel assembly (MODULATION) can be removed in the same way.**

21. LCD Unit (Time Required: About 7 minutes)

- 21-1 Separate the upper case unit and lower case unit. (See procedure 1.)
- 21-2 Remove the two (2) screws marked [S05O]. The stay hinge assembly can then be removed. (Fig. 11)
- 21-3 Remove the four (4) screws marked [S05P] and the screw marked [S05G]. (Fig. 9, 11)
- 21-4 Turn the front side of the upper case unit upward.
- * **Disconnect the connector assemblies of the LCD unit in advance.**
- 21-5 Release the lock at the back of the LCD unit, raise the LCD unit and remove the two (2) dust proof cloths. (Fig. 10, 12)
- 21-6 Tip the LCD unit until it is at an angle shown in Fig. 13, lift it a little and then pull it out obliquely upward. (Fig. 13)



[S05]: BIND HEAD TAPPING SCREW-B
3.0X10 MFZN2W3 (WE774200)

Fig. 11

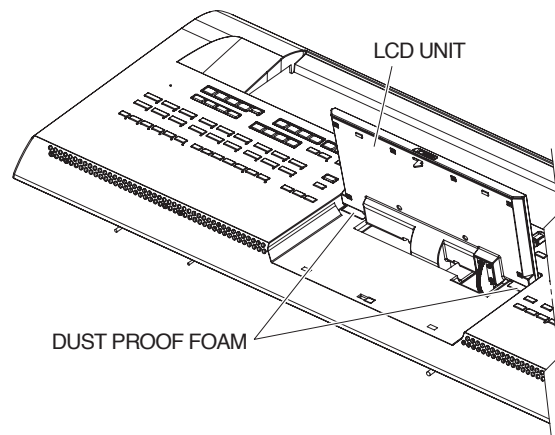


Fig. 12

**22. LCD Lower Assembly and Gear
(Time Required: About 7 minutes)**

- 22-1 Separate the upper case unit and lower case unit.
(See procedure 1.)
- 22-2 Remove the LCD unit. (See procedure 21.)
- 22-3 Remove the eight (8) screws marked [S04E], slide the LCD hook and remove the LCD lower assembly and gear while shifting the hook at the back of the LCD unit as shown in Photo 4. (Fig. 14, Photo 4)

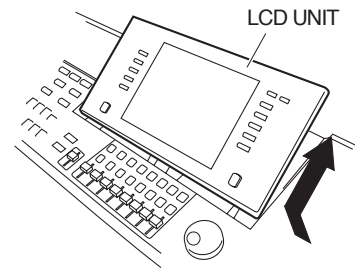
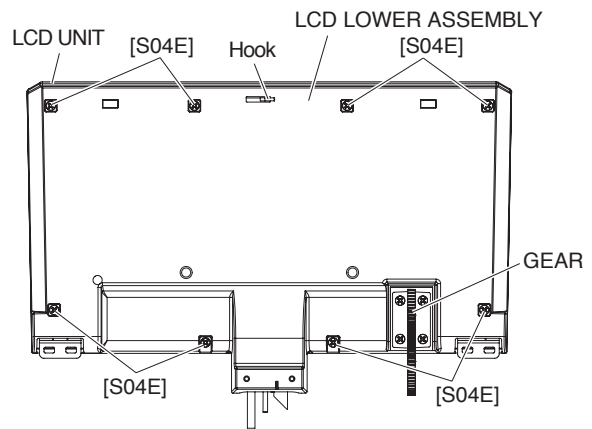


Fig. 13

**23. LCL Circuit Board
(Time Required: About 7 minutes)**

- 23-1 Separate the upper case unit and lower case unit.
(See procedure 1.)
- 23-2 Remove the LCD unit. (See procedure 21.)
- 23-3 Remove the LCD lower case assembly and gear.
(See procedure 22.)
- 23-4 Lift the stopper of the CN2 connector as shown in Fig. 15 and then remove the flat cable and ferrite core. (Fig. 15)
- 23-5 Remove the five (5) screws marked [S03J]. The LCL circuit board can then be removed. (Fig. 15)



[S04E]: BIND HEAD TAPPING SCREW-B
3.0X10 MFZN2B3 (WE972200)

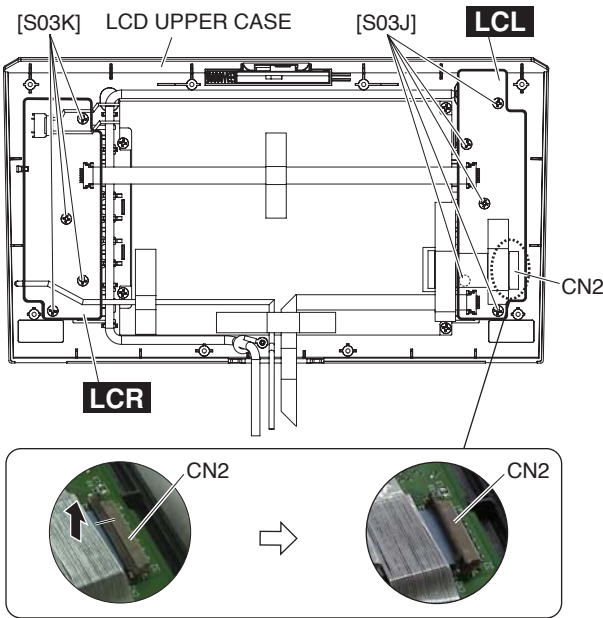
Fig. 14

**24. LCR Circuit Board
(Time Required: About 7 minutes)**

- 24-1 Separate the upper case unit and lower case unit.
(See procedure 1.)
- 24-2 Remove the LCD unit. (See procedure 21.)
- 24-3 Remove the LCD lower case assembly and gear.
(See procedure 22.)
- 24-4 Remove the four (4) screws marked [S03K]. The LCR circuit board can then be removed. (Fig. 15)

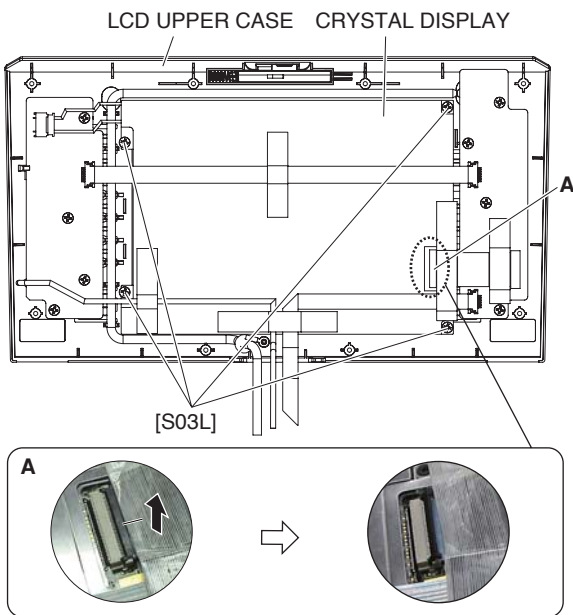


Photo 4



[S03]: BIND HEAD TAPPING SCREW-B
3.0X8 MFZN2W3 (WE774301)

Fig. 15



[S03L]: BIND HEAD TAPPING SCREW-B
3.0X8 MFZN2W3 (WE774301)

Fig. 16

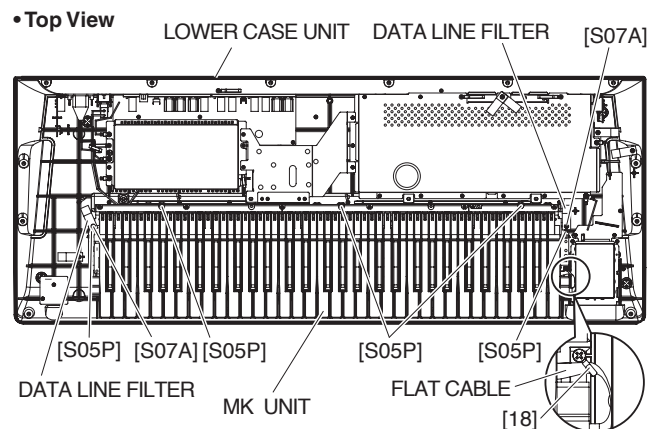
25. Crystal Display (Time Required: About 7 minutes)

- 25-1 Separate the upper case unit and lower case unit. (See procedure 1.)
- 25-2 Remove the LCD unit. (See procedure 21.)
- 25-3 Remove the LCD lower case assembly and gear. (See procedure 22.)
- 25-4 Lift the stopper of the connector at the portion [A] as shown in Fig. 16 and then remove the flat cable and ferrite core. (Fig. 16)
- 25-5 Remove the four (4) screws marked [S03L]. The crystal display can then be removed. (Fig. 16)

⚠ When connecting to the connector, pay attention not to insert the cable inversely.

26. Keyboard Assembly (Time Required: About 9 minutes)

- 26-1 Separate the upper case unit and lower case unit. (See procedure 1.)
- 26-2 Remove the two (2) screws marked [S07A]. The two (2) data line filters can then be removed. (Fig. 17)
- 26-3 Remove the eight (8) screws marked [S14B] and five (5) screws marked [S05P]. (Fig. 1, Fig. 17)
- * **Be sure to loosen the cord holder marked [18] and release the flat cable (PC sensor) from the cord holder before lifting the keyboard. (Fig.17)**
If the keyboard is lifted without releasing the flat cable from the cord holder, the flat cable or the sensor may be damaged.
- 26-4 Raise the MK unit from front side so that the front side will face upward while paying attention to the connector assemblies. (Photo 5)
- 26-5 Remove the screw marked [MS13] and two (2) screws marked [MS03]. The keyboard assembly can then be removed. (Fig. 18)



[S05P]: BIND HEAD TAPPING SCREW-B 3.0X10 MFZN2W3 (WE774200)
[S07A]: PW HEAD TAPPING SCREW-B 3.0X12 MFZN2W3 (WF00210R)

Fig. 17

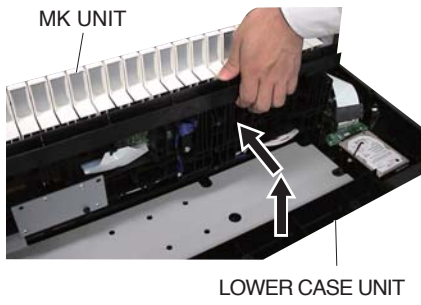
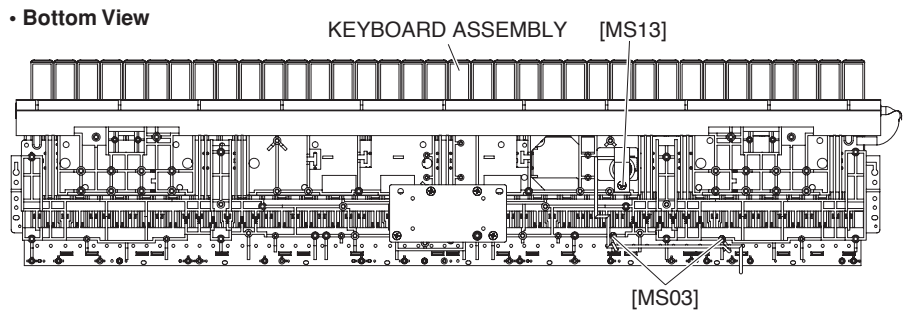


Photo 5



[MS03]: BIND HEAD TAPPING SCREW-B 3.0X8 MFZN2W3 (WE774301)
 [MS13]: BIND HEAD TAPPING SCREW-B 4.0X12 MFZN2W3 (WE98120R)

Fig. 18

27. Keys (White and Black Keys)

- 27-1 Remove the keyboard assembly.
(See procedure 26.)
- 27-2 Remove the key stoppers corresponding to the keys to be replaced. (Table 1, Fig. 19)
- 27-3 **White key**
- 27-3-1 Place the white key in the horizontal position and remove it, lifting while pushing rearward. (Photo 6)
- * *At this time, a key guide cap may come off together. (Photo 8)*
- 27-4 **Black key**
- 27-4-1 Remove the white keys on the right and left sides of the black key to be removed. (Photo 6)
- 27-4-2 Place the black key in the horizontal position and remove it, lifting while pushing rearward. (Photo 7)



Photo 6



Photo 7



Photo 8

Table 1

	KEY STOPPER L	KEY STOPPER H	KEY STOPPER 61
REMOVE SCREW	[240A] X 2, [240B] X 1	[240B] X 1, [240C] X 2	[240D] X 2

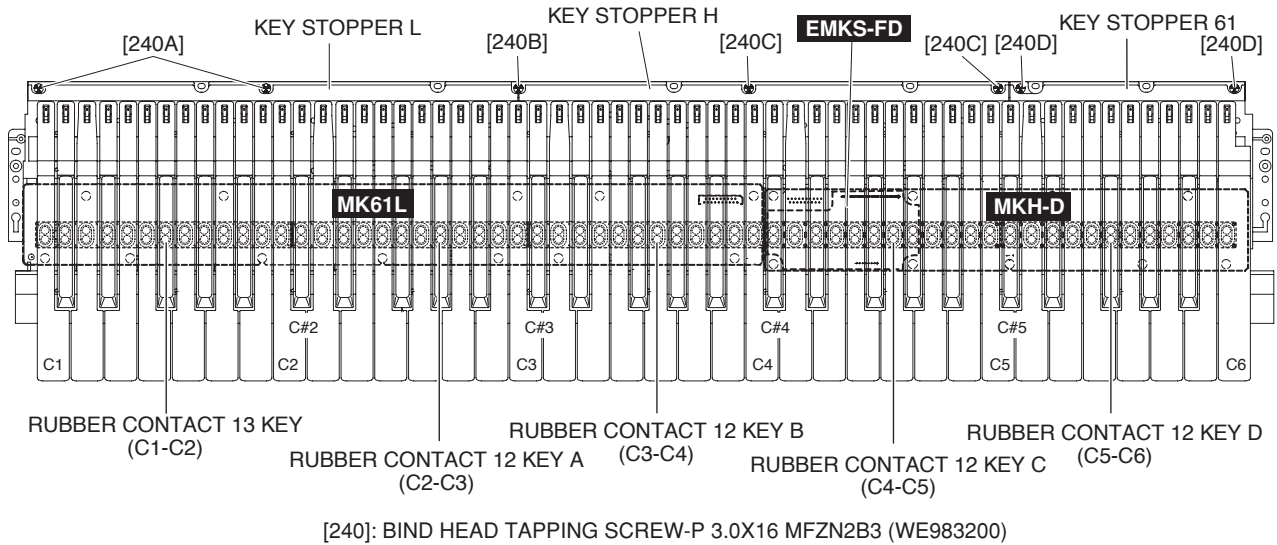


Fig. 19

28. Installing Keys (White and Black Keys)

28-1 Black key

28-1-1 With the white keys to the right and left sides removed, lower the front end of the horizontal black key and fit it into the frame while pushing it rearward.

* **At this time, pay attention not to bend the key guide cap by lowering the front portion of the key too much. (Photo 8)**

28-2 White key

28-2-1 After installing the black keys, install the white keys in the same way as the black keys.

(See procedure 28-1.)

28-3 Install the removed key stoppers.

(Table 1, Fig. 19)

29. Disassembling Keyboard Assembly

29-1 Rubber Contact

29-1-1 Remove the keyboard assembly.

(See procedure 26.)

29-1-2 Remove the key stoppers and keys listed in the table 2, corresponding to the rubber contacts to be removed. (Table 2, fig. 19) (See procedure 27.)

29-1-3 Pull out the rubber contact. (Fig. 19)

* **The orientation of rubber contacts on the keyboard is previously designated. Pay attention not to install the rubber contacts inversely. (Fig. 20)**

* **When installing the rubber contact, push it with the end of a clip. (Photo 9)**

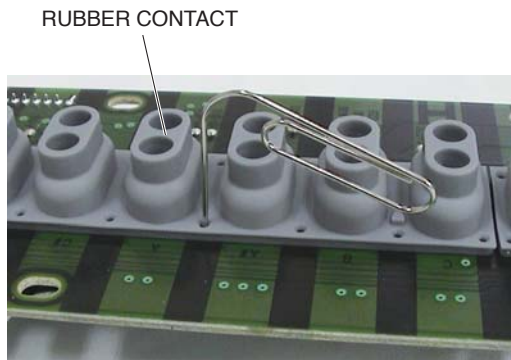


Photo 9

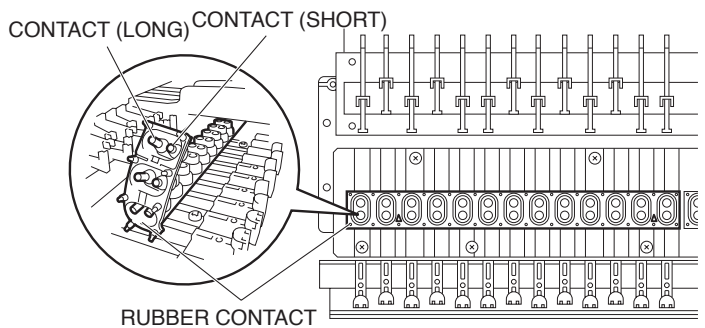
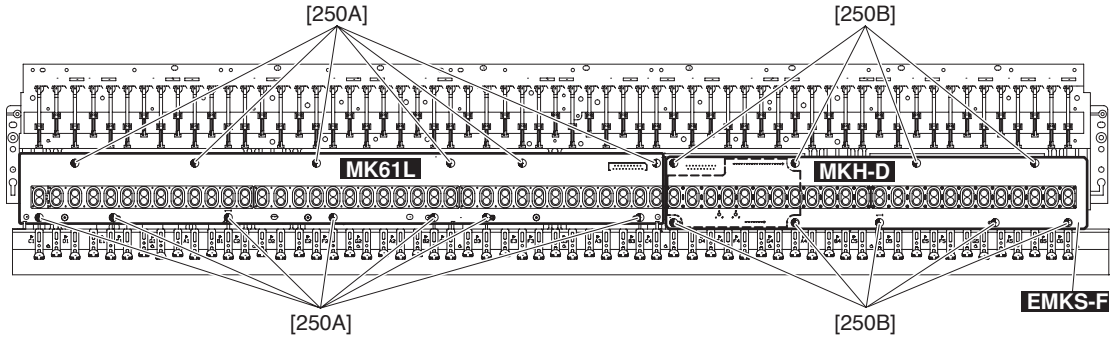


Fig. 20

Table 2

	RUBBER CONTACT 13KEY	RUBBER CONTACT 12KEY A	RUBBER CONTACT 12KEY B	RUBBER CONTACT 12KEY C	RUBBER CONTACT 12KEY D
APPLICATION CIRCUIT BOARD	MK61L	MK61L	MK61L	MKH-D	MKH-D
REMOVE KEY STOPPER	L	L, H	L, H	H	61
REMOVE KEY	C1-C2	C2-C3	C3-C4	C4-C5	C5-C6



[250]: BIND HEAD TAPPING SCREW-P 3.0X8 MFZN2B3 (WF266600)

Fig. 21

29-2 **MK61L Circuit Board**

(Time required: About 8 minutes)

- 29-2-1 Remove the keyboard assembly.
(See procedure 26.)
- 29-2-2 Remove the key stopper L and key stopper H. (Table 1, Fig. 19)
- 29-2-3 Remove the keys and the key springs from C1 to C4.
(See procedure 27.)
- 29-2-4 Remove the thirteen (13) screws marked [250A] and disconnect the connector from the underside of the keyboard unit. The MK61L circuit board can then be removed. (Fig. 21, Photo 10)

* **The rubber contacts are not parts of the MK61L circuit board. When replacing the MK61L circuit board, remove the rubber contacts from the circuit board and install them to new circuit board.**

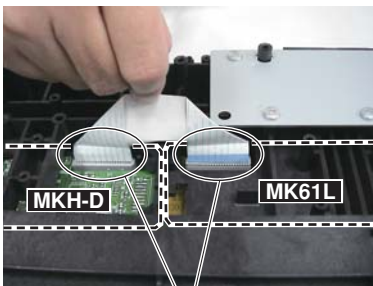
29-3 **MKH-D Circuit Board, EMKS-FD Circuit Board**

(Time required: About 8 minutes)

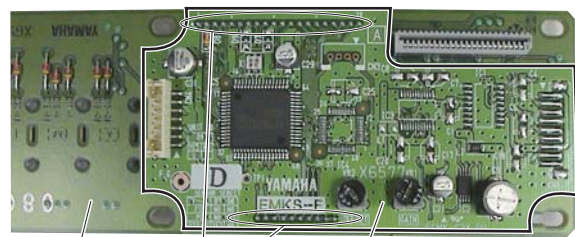
- 29-3-1 Remove the keyboard assembly.
(See procedure 26.)
- 29-3-2 Remove the key stopper H and key stopper 61. (Table 1, Fig. 19)
- 29-3-3 Remove the keys and key springs from C4 to C6.
(See procedure 27.)
- 29-3-4 Remove the nine (9) screws marked [250B] and disconnect the connectors from the underside of the keyboard. The MKH-D circuit board can then be removed. (Fig. 21, Photo 10)

* **The EMKS-FD circuit board is a part of the MKH-D circuit board and is soldered to the MKH-D circuit board at connectors. (Photo 11)**

* **The rubber contacts are not parts of the MKC circuit board. When replacing the MKC circuit board, remove the rubber contacts from the circuit board and install them to new circuit board.**



Connector
Photo 10

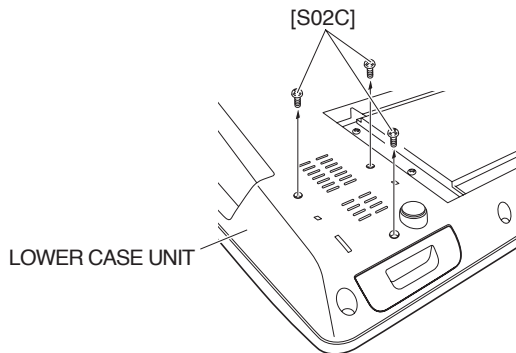


Soldered
Photo 11

30. Hard Disk Drive Unit

Turn the Tyros3's power off, disconnect any cables including AC power cord from the keyboard.
 Also make sure to close the LCD panel and disconnect a USB device from the USB TO DEVICE terminal.
 Turn the Tyros3 face down on a blanket or some soft surface, giving you direct access to the bottom of the instrument.

- 30-1 Remove the three (3) screws marked [S02C].
 (Fig. 1, Fig. 22)



[S02C]: BIND HEAD SCREW 3.0X8 MFZN2B3 (WE983600)
 Fig. 22

- 30-2 Pull out the HDD bracket. (Fig. 23)

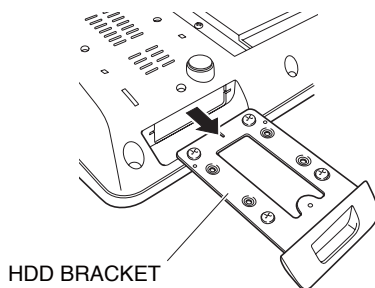
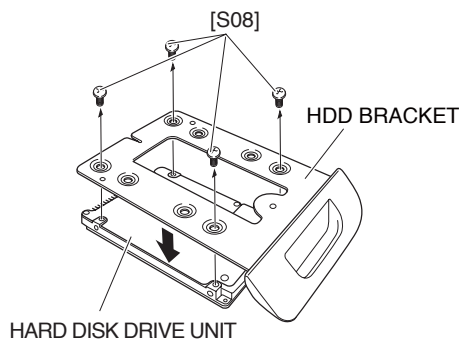


Fig. 23

- 30-3 Remove the four (4) screws marked [S08]. The hard disk drive unit can then be removed. (Fig. 24)



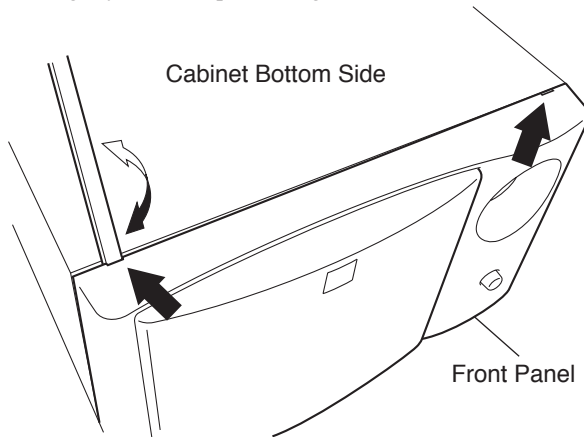
[S08]: BIND HEAD SCREW 3.0X4 MFNI33 (VG048000)
 Fig. 24

■ DISASSEMBLY PROCEDURE (TRS-MS02)

1. Grille Assembly

(Time required: About 2 minutes)

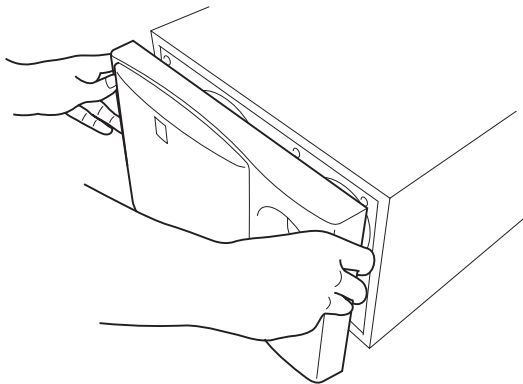
- 1-1 Lay the unit upside down, insert a thin plate such as a ruler into the two slits on the bottom, then unclench slightly the front panel. (Fig.1)



(Fig.1)

* Take great care not to damage the cabinet. Stop unclenching when a small clearance is formed.

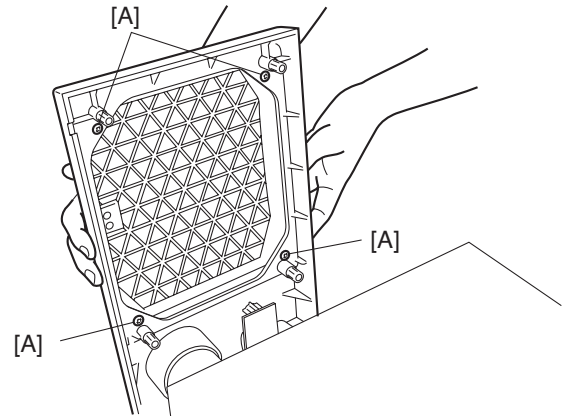
- 1-2 Pull the front panel forward to remove. (Fig.2)



(Fig.2)

* The front panel is fixed on the cabinet by six dowels, so take care not to force diagonally too much.

- 1-3 Remove the four (4) screws marked [A]. The grille assembly can then be removed. (Fig.3)



(Fig.3)

2. AC Power Cord

(Time required: About 3 minutes)

- 2-1 Remove the eight (8) screws marked [B]. The rear panel can then be removed.

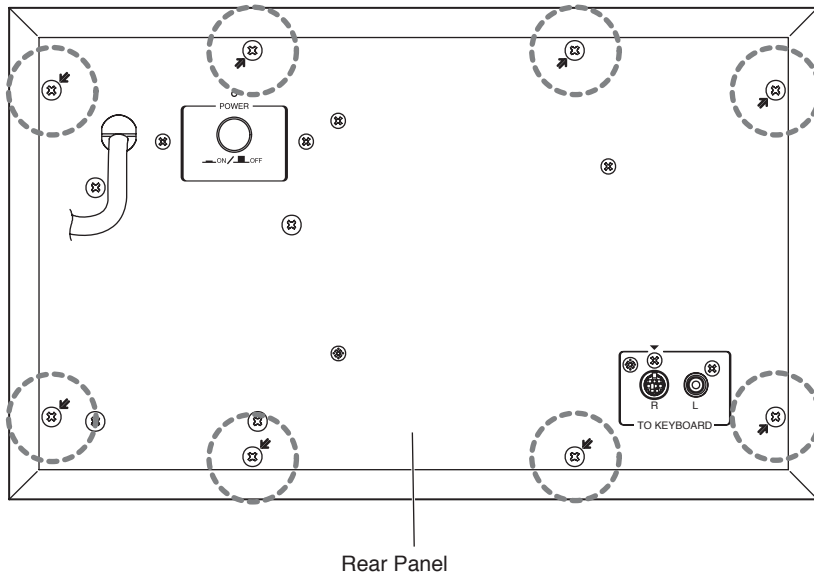
(The screws to be removed are indicated by arrows ‘->’ on the rear panel.) (Fig.4)

* When reinstalling the rear panel, confirm that the packing is not damaged to avoid air leakage. (Fig.5)

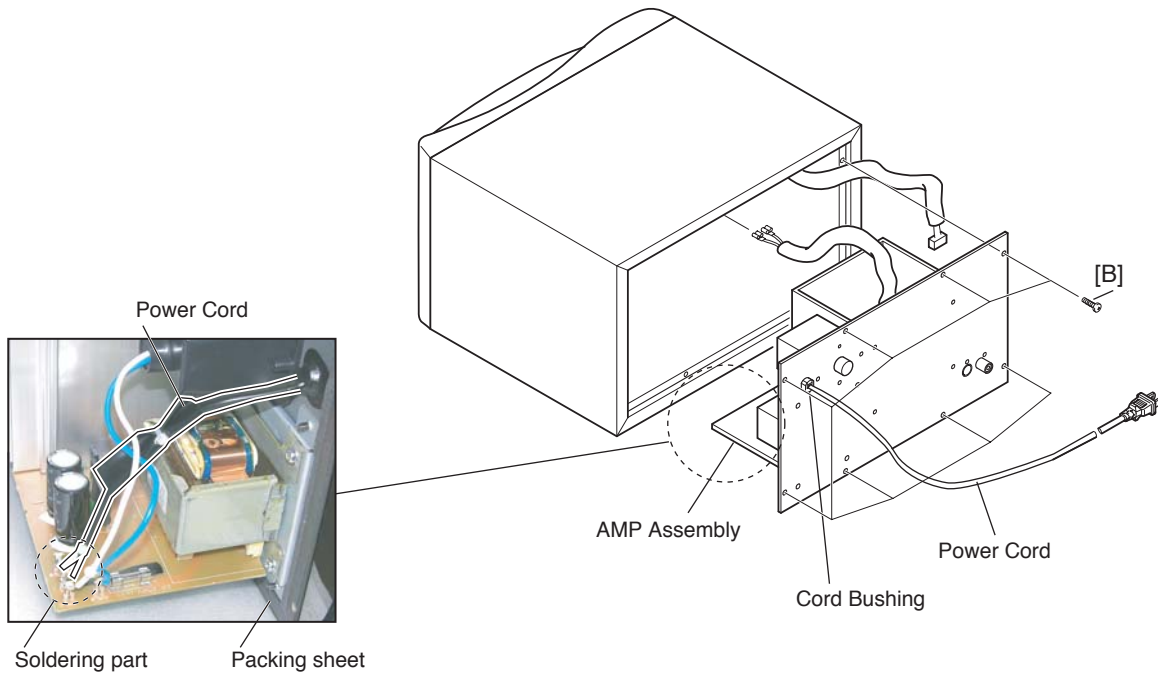
- 2-2 Remove the soldering portions of the AC power cord from the AMP assembly. (Fig.5)

- 2-3 Remove the cord bushing from the rear panel. The AC power cord can then be removed. (Fig.5)

* When reinstalling the rear panel, confirm that the packing is not damaged to avoid air leakage. (Fig.5)



(Fig.4)



(Fig.5)

Fig. 1

■ INSTALLING THE OPTIONAL DIMMS

Installing optional DIMMs to the Tyros3 allows you to save large amounts of Voice data created by the Voice Creator function. This section explains how to install DIMM memory modules to the Tyros3.

⚠ WARNING

- Before beginning installation, switch off the power to the Tyros3 and connected peripherals, and unplug them from the power outlet. Then remove all cables connecting the Tyros3 to other devices. (Leaving the power cord connected while working can result in electric shock. Leaving other cables connected can interfere with work.)
- Be careful not to drop any screws inside the instrument during installation (this can be prevented by keeping the optional units and cover away from the instrument while attaching). If this does happen, be sure to remove the screw(s) from inside the unit before turning the power on. Loose screws inside the instrument can cause improper operation or serious damage.
- Install the optional units carefully as described in the procedure below. Improper installation can cause shorts which may result in irreparable damage and pose a fire hazard.

⚠ CAUTION

- Do not touch the exposed metal parts in the circuit board. Touching these parts may result in a faulty contact.
- Be careful not to misplace any of the screws since all of them are used.
- Be careful of static electricity. Static electricity discharge can damage the DIMMs or the instrument. Before you handle the DIMMs, to reduce the possibility of static electricity, touch some unpainted metal surface or a ground wire on a device that is grounded.
- Do not use any screws other than what are installed on the instrument.

Compatible DIMMs

The Tyros3 does not necessarily support all commercially available DIMMs. Yamaha cannot guarantee operation of DIMMs that you purchase. Before purchasing DIMMs, see the following page:
<http://music-tyros.com/>

DIMM Type and DIMM Configuration

- Yamaha recommends that you purchase DIMMs that conform to the JEDEC* standard. Please be aware, however, that conformance to this standard does not constitute a guarantee that the DIMMs will operate correctly on the Tyros3.
- * JEDEC (*Joint Electron Device Engineering Council*) sets standards for terminal configurations within electronic devices.
- Use only 168-pin DIMMs of 64, 128, 256 or 512 MB capacity (synchronized DRAM; PC100 or PC133).
- Use only DIMMs that have a height of 38.2 mm or less.
- When installing DIMMs, make sure to install them in a matched pair of the same capacity. You cannot install only one module and leave the second memory socket open. Also make sure each DIMM in the pair is of the same manufacturer and the same type. DIMMs of different makers and configurations may not work together.
- When purchasing DIMMs, make sure that the DIMM design does not utilize more than 18 memory chips per module. (DIMMs comprised of more than 18 chips do not operate correctly on the Tyros3.)

DIMM Installation

Before following the steps below, make sure you have

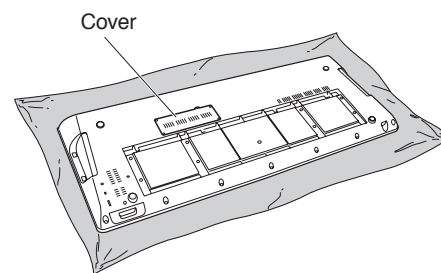
appropriate DIMMs and a Phillips screwdriver.

1 Turn the Tyros3's power off, and disconnect any cables including AC power cord from the keyboard.

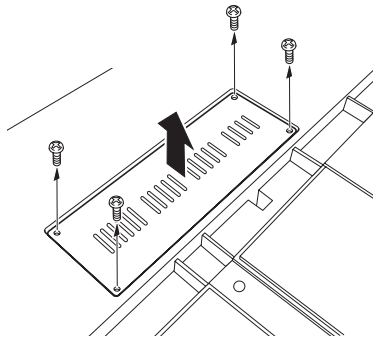
Also make sure to close the LCD panel and disconnect a USB device from the USB TO DEVICE terminal.

2 Turn the Tyros3 face down on a blanket or some soft surface, giving you direct access to the bottom of the instrument.

3 Remove the four screws from the cover.

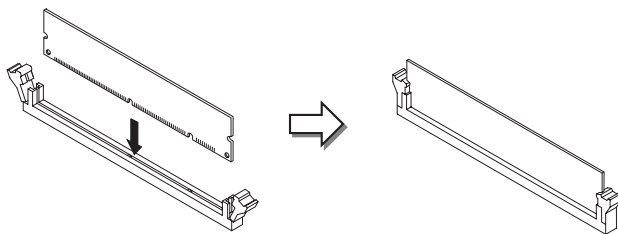
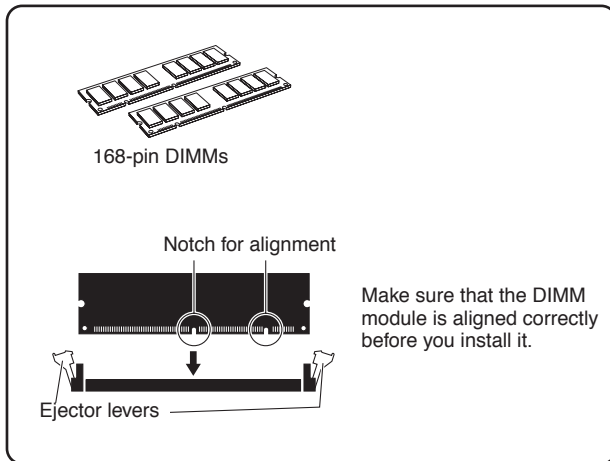


4 Insert the two DIMMs into the DIMM sockets.



Open the ejector levers, then insert the DIMM vertically in the socket.

5 Re-install the cover you removed in step 3, in reverse order.



Insert the DIMM vertically in the socket, aligning the notches to the corresponding protrusions.

Press it in firmly until it "snaps" or locks in place.

6 Check that the installed DIMMs are functioning properly.

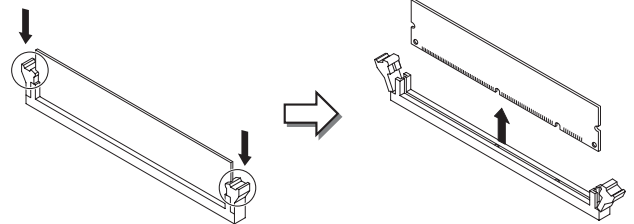
Set the Tyros3 right-side up, turn the power on and check the WAVE RAM by accessing [VOICE CREATOR] → [B] LIBRARY EDIT → [8 ▼] PROPERTY.

If the DIMMs have been installed properly, the appropriate available memory size is indicated in the display.

Removing DIMMs

Press the ejector levers until the DIMM unlocks.

Pull the DIMM vertically out of the socket.



REPLACING THE INTERNAL HARD DISK

If the factory-installed hard disk crashes or when you want to replace it with another one (for example, one you have used on the Tyros/Tyros2), you can remove the current one and install the new one by following the procedure below. The hard disk used must be a 2.5-inch P-ATA (parallel ATA) compatible; however, not all such drives may be installable.

⚠ WARNING

- Before beginning, switch off the power to the Tyros3 and connected peripherals, and unplug them from the power outlet. Then remove all cables connecting the Tyros3 to other devices. (Leaving the power cord connected while working can result in electric shock. Leaving other cables connected can interfere with work.)
- Be careful not to drop any screws inside the instrument. If this does happen, be sure to remove the screw(s) from inside the unit before turning the power on. Loose screws inside the instrument can cause improper operation or serious damage. If you are unable to retrieve a dropped screw, consult your Yamaha dealer for advice.
- Install the hard disk units carefully as described in the procedure below. Improper installation can cause shorts which may result in irreparable damage and pose a fire hazard.
- Do not disassemble, modify, or apply excessive force to board areas and connectors on hard disk units. Bending or tampering with boards and connectors may lead to electric shock, fire, or equipment failures.

⚠ CAUTION

- Before removing the installed hard disk unit, make sure to backup any necessary data on the disk to computer by using the USB Storage Mode. This will prevent loss of important data and enable you to use the data on the new hard disk. (If you need to backup the recorded audio files, save the hidden folder "HDR.ROOT" to the computer.)
- It is recommended that you wear gloves to protect your hands from metallic projections on hard disk units and other components. Touching leads or connectors with bare hands may cause finger cuts, and may also result in poor electrical contact or electrostatic damage.
- Handle the hard disk unit with care. Dropping or subjecting them to any kind of shock may cause damage or result in a malfunction.
- Be careful of static electricity. Static electricity discharge can damage the IC chips on the hard disk or the instrument. Before you handle the hard disk, to reduce the possibility of static electricity, touch the metal parts other than the painted area or a ground wire on the devices that are grounded.
- Do not touch the exposed metal parts in the circuit board. Touching these parts may result in a faulty contact.
- Be careful not to misplace any of the screws since all of them are used.
- Do not use any screws other than what are installed on the instrument.

NOTE

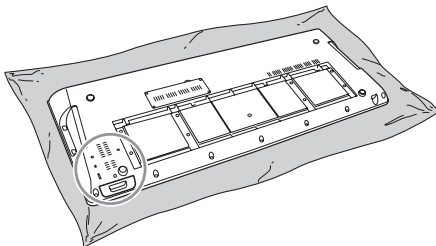
- Hard disk drives thicker than 12.7 mm cannot be installed to the Tyros3.
- S-ATA compatible hard disks cannot be used.

Before following the steps below, make sure you have an appropriate hard disk drive and a Phillips screwdriver.

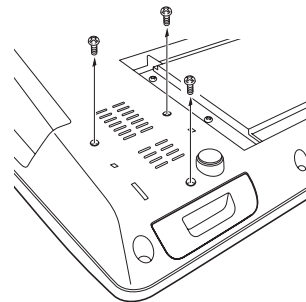
1 Turn the Tyros3's power off, disconnect any cables including AC power cord from the keyboard.

Also make sure to close the LCD panel and disconnect a USB device from the USB TO DEVICE terminal.

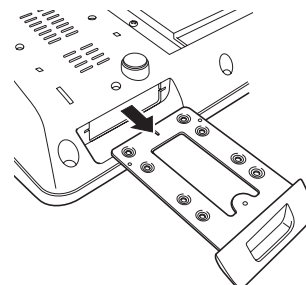
2 Turn the Tyros3 face down on a blanket or some soft surface, giving you direct access to the bottom of the instrument.



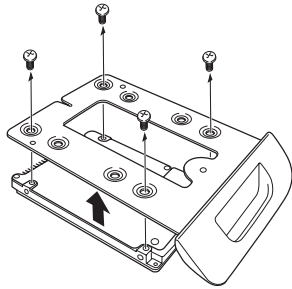
3 Remove the three screws.



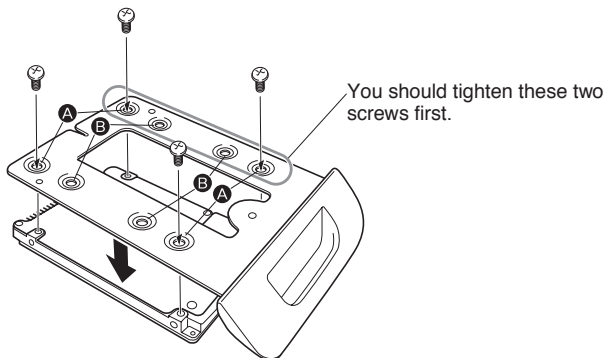
4 Pull out the hard disk bracket.



- 5** Remove the four screws to remove the installed hard disk unit from the bracket.

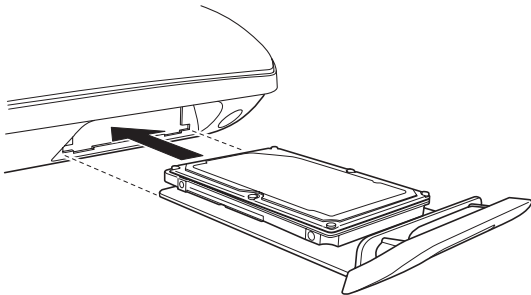


- 6** Attach the new hard disk unit to the bracket using the four screws removed in step 5.

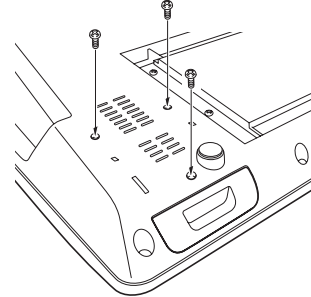


Make sure the bottom of the hard disk is facing up. Depending on the type of hard disk drive you plan to install, select holes **A** or holes **B** to attach the hard disk drive.
 * Holes **A** are used in this illustration.

- 7** Set the Tyros3 right-side up.
8 Insert the hard disk bracket into the slot.



- 9** Turn the Tyros3 face down again and fasten the three screws removed in step 3.



- 10** Check that the installed hard disk is functioning properly.

Set the Tyros3 right-side up, and turn the power on. If the HD tab appears on the File Selection display, the hard disk is OK.

NOTE

If you have installed the hard disk that was once used for the Tyros/Tyros2 and turn the Tyros3's power on, you can immediately view the files on the hard disk and use the Song files from the Tyros/Tyros2. However, to properly use the Style, Multi Pad, and Registration Memory files from the Tyros/Tyros2, you will need to convert the data using a computer and the File Converter software (available for free download on the Tyros3 website).

LSI PIN DESCRIPTION

AK4396VF-E2 (X8324A00) DAC (Digital to Analog Converter)	42
AK5381VT-E2 (X5219A0R) ADC (Analog to Digital Converter).....	41
DM9000AEP (X7029A00) LAN CONTROLLER	41
DS99R103TSQX/NOPB (X9323A00) LVDS	42
DS99R104TSQX/NOPB (X9324A00) LVDS	43
HD6417727F160CV (X2890B00) CPU	31
HD6433693B14HV (X480120R) E-VKS	30
ISP1761BE (X9073A00) HI-SPEED USB OTG CONTROLLER	38
LC4256V-75TN100 (X6046B0R) CPLD (MAT)	36
M34519M6-521FP (X5646200) CPLD (Complex Programmable Logic Device)	41
MB3516APF-G-BND-EF (X2314A00) RGB ENCODER	40
R5S72060W200FPV (X8924A00) CPU	32—33
S1L50553F21Y000 (X4195A0R) MCI (Gate Array)	40
S1L52502F24J200 (X2688A0R) GATE ARRAY	39
T6TZ2XBG-0002 (X7376B00) SWP51 (Tone Generator)	34—35
YGV628B-VZ (X6356B00) RGB CONTROLLER AVDP7	37
μPD780031AYGK-N09 (XZ916300) E-PNS2a LED/SWITCH DRIVER	43

● HD6433693B14HV (X480120R) E-VKS

EMKS-FD: IC005

PIN NO.	NAME	I/O	FUNCTION	PIN NO.	NAME	I/O	FUNCTION
1	NC		} Not used	33	NC		} Not used
2	NC			34	NC		
3	AVcc	-	Power supply	35	NMI	I	Non maskable interrupt
4	X2	O	} Crystal resonator	36	P80/FTCI	I/O	8-bit I/O port / External event input
5	X1	I		37	P81/FTIOA	I/O	8-bit I/O port / Output compare
6	V _{CL}	-	Power supply	38	P82/FTIOB	I/O	8-bit I/O port / Output / input capture
7	RES	I	Reset pin	39	P83/FTIOC	I/O	8-bit I/O port / Input PWM
8	TEST	I	Test pin	40	P84/FTIOD	I/O	8-bit I/O port / Output
9	V _{SS}	-	Ground	41	P85	I/O	} 8-bit I/O port
10	OSC2	O	} Crystal or ceramic resonator	42	P86	I/O	
11	OSC1	I		43	P87	I/O	
12	V _{CC}	-	Power supply	44	P20/SCK3	I/O	3-bit I/O port / Clock
13	P50/WKP0	I/O	} 8-bit I/O port / Interrupt request	45	P21/RXD	I/O	3-bit I/O port / Receive data input
14	P51/WKP1	I/O		46	P22/TXD	I/O	3-bit I/O port / Transmit data output
15	NC		} Not used	47	NC		
16	NC			48	NC		
17	NC			49	NC		
18	NC			50	NC		
19	P52/WKP2	I/O	} 8-bit I/O port / Interrupt request	51	P14/IRQ0	I/O	} 7-bit I/O port / Interrupt request
20	P53/WKP3	I/O		52	P15/IRQ1	I/O	
21	P54/WKP4	I/O	} 8-bit I/O port / Interrupt request / A/D converter trigger	53	P16/IRQ2	I/O	} 7-bit I/O port / Interrupt request / Trigger input
22	P55/WKP5/ADTRG	I/O		54	P17/IRQ3/TRGV	I/O	
23	P10/TMOW	I/O	} 7-bit I/O port	55	PB4/AN4	I/O	} 8-bit I/O port / Analog input
24	P11	I/O		56	PB5/AN5	I/O	
25	P12	I/O	} IIC data I/O pin	57	PB6/AN6	I/O	
26	SDA	I/O		58	PB7/AN7	I/O	
27	SCL	I/O	} 3-bit I/O port / Timer	59	PB3/AN3	I/O	
28	P74/TMRIV	I/O		60	PB2/AN2	I/O	
29	P75/TMCIV	I/O	} Not used	61	PB1/AN1	I/O	
30	P76/TMOV	I/O		62	PB0/AN0	I/O	
31	NC			63	NC		
32	NC			64	NC		

● R5S72060W200FPV (X8924A00) CPU

DM: IC507

PIN NO.	NAME	I/O	FUNCTION	PIN NO.	NAME	I/O	FUNCTION	
1	RD	O	Read	53	PE15 /	I/O	General port /	
2	PA8 /	I/O	General port /		TIOC4D /	I/O	MTU2 input capture/output compare (channel 4) /	
	RD/WR	O	Read/write signal		DACK1 /	O	DMA-transfer request accept /	
3	PVss	I	Ground for I/O circuits		IRQOUT / CKE	O	Interrupt request output / CK enable	
4	PC1 /	I	General port /	54	MD_CLK2	I	} Clock mode set	
	A1	O	Address bus	55	MD_CLK0	I		
5	A2	O	} Address bus	56	Vss	I	Ground	
6	A3	O			57	Vcc	I	Power supply
7	A4	O			58	MD2	I	} Mode set
8	A5	O			59	MD0	I	
9	A6	O			60	PA9 /	I/O	General port /
10	A7	O				TCLKD / IRQ3 /	I	MTU2 timer clock input / Interrupt requests 3 /
11	A8	O			FRAME / CKE	O	FRAME signal / CK enable	
12	A9	O		61	PE9 / TIOC3B /	I/O	General port / MTU2 input capture/output	
13	Vcc	I	Power supply		SCK3 /	I/O	compare (channel 3) / Serial clock /	
14	Vss	I	Ground		RTS3	O	Transmit request	
15	PVss	I	Ground for I/O circuits	62	PA17 /	I/O	General port /	
16	PVcc	I	Power supply for I/O circuits		WAIT /	I	Wait /	
17	A10	O	} Address bus		DACK2	O	DMA-transfer request accept	
18	A11	O			63	PVcc	I	Power supply for I/O circuits
19	A12	O			64	PVss	I	} Ground for I/O circuits
20	A13	O			65	PVss	I	
21	A14	O			66	PE13 /	I/O	General port /
22	A15	O				TIOC4B /	I/O	MTU2 input capture/output compare (channel 4) /
23	A16	O			MRES	I	Manual reset	
24	Vcc	I	Power supply	67	CS0	O	Chip select 0	
25	Vss	I	Ground	68	PA11 /	I/O	General port /	
26	A17	O	} Address bus		CS1 /	O	Chip select 1 /	
27	A18	O				POE5	I	Port output control
28	A19	O			69	PE8 /	I/O	General port /
29	A20	O				TIOC3A /	I/O	MTU2 input capture/output compare (channel 3) /
30	PA18 /	I/O	General port /		SCK2	I/O	Serial clock	
	BREQ /	I	Bus-mastership request /	70	PA24 /	I/O	General port /	
	TEND0 /	O	DMA-transfer end output /		CE2A /	O	Upper byte select for PCMCIA card /	
	PINT2	I	Interrupt requests 2		DREQ3 / PINT6	I	DMA-transfer request / Interrupt requests 6	
31	PVcc	I	Power supply for I/O circuits	71	PA25 /	I/O	General port /	
32	CKIO	I/O	System clock I/O		CE2B /	O	Upper byte select for PCMCIA card /	
33	PVss	I	Ground for I/O circuits		DACK3 /	O	DMA-transfer request accept /	
34	PLLvss	I	Ground for PLL		PINT7 / POE8	I	Interrupt requests 7 / Port output control	
35	PLLvcc	I	Power supply for PLL	72	PB3 / IRQ1 / POE1 /	I	General port / Interrupt requests 1 / Port output control /	
36	PVcc	I	Power supply for I/O circuits		SDA	I/O	Serial data pin	
37	RES	I	Power-on reset	73	PB2 / IRQ0 /	I	General port / Interrupt requests 0 /	
38	PVss	I	Ground for I/O circuits		POE0 /	I	Port output control /	
39	XTAL	O	Crystal		SCL	I/O	Serial clock pin	
40	EXTAL	I	External clock	74	PE7 /	I/O	General port /	
41	PVss	I	Ground for I/O circuits		TIOC2B /	I/O	MTU2 input capture/output compare (channel 2) /	
42	PVcc	I	Power supply for I/O circuits		RxD2 /	I	Receive data /	
43	NMI	I	Non-maskable interrupt		BS / UBCTRG	O	Bus start / User break trigger output	
44	PVss	I	} Ground for I/O circuits	75	PE0 /	I/O	General port /	
45	PVss	I				TIOC0A /	I/O	MTU2 input capture/output compare (channel 0) /
46	PB9 /	I/O	General port /		DREQ0 /	I	DMA-transfer request /	
	A21 /	O	Address bus /		AUDCK	O	AUD clock	
	IRQ7 / ADTRG /	I	Interrupt requests 7 / A/D conversion trigger input	76	PVcc	I	Power supply for I/O circuits	
	POE8	I	/ Port output control	77	PVss	I	Ground for I/O circuits	
47	PA5 / SCK1 /	I/O	General port / Serial clock /	78	Vss	I	Ground	
	DREQ1 / IRQ1 /	I	DMA-transfer request / Interrupt requests 1 /	79	Vcc	I	Power supply	
	A22	O	Address bus	80	PE3 /	I/O	General port /	
48	PA4 /	I/O	General port /		TIOC0D /	I/O	MTU2 input capture/output compare (channel 0) /	
	TxD1 / A23	O	Transmit data / Address bus		TEND1 / AUDATA3	O	DMA-transfer end output / AUD data	
49	PA3 /	I/O	General port /	81	PA1 /	I/O	General port /	
	RxD1 /	I	Receive data /		TxD0 /	O	Transmit data /	
	A24	O	Address bus		PINT1 /	I	Interrupt requests 1 /	
50	PA2 / SCK0 /	I/O	General port / Serial clock /		CS5/CE1A	O	Chip select 5/Lower byte select for PCMCIA card	
	DREQ0 / IRQ0 /	I	DMA-transfer request / Interrupt requests 0 /	82	PE5 /	I/O	General port /	
	A25	O	Address bus		TIOC1B /	I/O	MTU2 input capture/output compare (channel 1) /	
51	PC0 /	I/O	General port /		TxD3 / AUDATA1 /	O	Transmit data / AUD data	
	A0	O	Address bus		CS6/CE1B	O	Chip select 6/Lower byte select for PCMCIA card	
52	PE16 /	I/O	General port /	83	PE1 /	I/O	General port /	
	CS8	O	Chip select 8		TIOC0B /	I/O	MTU2 input capture/output compare (channel 0) /	
					TEND0	O	DMA-transfer end output	

PIN NO.	NAME	I/O	FUNCTION	PIN NO.	NAME	I/O	FUNCTION	
84	PE6 / SCK3 / TIOC2A /	I/O	General port / Serial clock / MTU2 input capture/output compare (channel 2) /	135	PD21 / D21	I/O	} General port / Data bus	
	AUDATA0 / CS7	O	AUD data / Chip select 7	136	PD20 / D20	I/O		
85	PA0 /	I/O	General port /	137	PD19 / D19	I/O		
	RxD0 / PINT0 /	I	Receive data / Interrupt requests 0 /	138	PD18 / D18	I/O		
	CS4	O	Chip select 4	139	PD17 / D17	I/O		
86	PE4	I/O	General port	140	PD16 / D16	I/O		
87	PE2 /	I/O	General port /	141	PD15 / D15	I/O		
	TIOC0C /	I/O	MTU2 input capture/output compare (channel 0) /	142	PD14 / D14	I/O		
	DREQ1	I	DMA-transfer request	143	PD13 / D13	I/O		
88	PE14	I/O	General port	144	Vss	I		Ground
89	AVss	I	Analog ground	145	Vcc	I	Power supply	
90	PF0 / AN0	I	} General port / Analog input pins	146	PD12 / D12	I/O	General port / Data bus	
91	PF1 / AN1	I			147	PVss	I	Ground for I/O circuits
92	PF2 / AN2	I			148	PD11 / D11	I/O	General port / Data bus
93	PF3 / AN3	I			149	PVcc	I	Power supply for I/O circuits
94	PF4 / AN4	I			150	PD10 / D10	I/O	} General port / Data bus
95	PF5 / AN5	I			151	PD9 / D9	I/O	
96	PF6 / AN6 / DA0	I O		General port / Analog input pins / Analog output pins	152	PD8 / D8	I/O	} Data bus
97	PF7 / AN7 / DA1	I O	General port / Analog input pins / Analog output pins	153	D7	I/O		
98	AVref	I	Analog reference voltage	154	D6	I/O		
99	AVcc	I	Analog power supply	155	D5	I/O		
100	PE10 /	I/O	General port /	156	D4	I/O	} Ground	
	TIOC3C /	I/O	MTU2 input capture/output compare (channel 3) /	157	D3	I/O		
	TxD2	O	Transmit data	158	Vss	I	Power supply	
101	Vcc	I	Power supply	159	Vcc	I	} Data bus	
102	Vss	I	Ground	160	D2	I/O		
103	PE11 /	I/O	General port	161	D1	I/O	} Ground for I/O circuits	
	TIOC3D /	I/O	MTU2 input capture/output compare (channel 3) /	162	PVss	I		Power supply for I/O circuits
	RxD3 / CTS3	I	Receive data / Transmit enable	163	PVcc	I	Power supply for I/O circuits	
104	ASEBRKAK/ASEBRK	I/O	Break mode acknowledge/Break request	164	D0	I/O	Data bus	
105	PE12 /	I/O	General port /	165	PA21 /	I/O	General port /	
	TIOC4A /	I/O	MTU2 input capture/output compare (channel 4) /		CS5/CE1A /	O	Chip select 5/Lower byte select for PCMCIA card /	
	TxD3	O	Transmit data		CASU /	O	CAS /	
106	WDTOVF	O	Watchdog timer overflow	166	TIC5U /	I	MTU2 input capture (channel 5) /	
107	ASEBCK	O	ASECK output		PINT5	I	Interrupt requests 5	
108	PVcc	I	Power supply for I/O circuits		PB5 /	I/O	General port /	
109	PA19 /	I/O	General port /		IRQ3 / POE3 /	I	Interrupt requests 3 / Port output control /	
	BACK /	O	Bus-mastership request acknowledge /		CASL	O	CAS	
	TEND1 /	O	DMA-transfer end output /	167	PA16 /	I/O	General port /	
	PINT3	I	Interrupt requests 3		WE3/DQMUI/AH/CIOWR /	O	Byte select/Byte select/Address hold/Write strobe for PCMCIA I/O /	
110	TCK	I	Test clock		DREQ2 /	I	DMA-transfer request /	
111	TRST	I	Test reset		AUDSYNC / CKE	O	AUD sync signal / CK enable	
112	TDI	I	Test data input	168	PA6 /	I/O	General port /	
113	PVss	I	Ground for I/O circuits		TCLKA /	I	MTU2 timer clock input /	
114	Vss	I	Ground	169	CS2 /	O	Chip select 2	
115	Vcc	I	Power supply		PA7 /	I/O	General port /	
116	TMS	I	Test mode select		TCLKB /	I	MTU2 timer clock input /	
117	PVcc	I	Power supply for I/O circuits		CS3 /	O	Chip select 3	
118	PVss	I	Ground for I/O circuits	170	PA23 /	I/O	General port /	
119	ASEMD	I	Debugging mode		WE3/DQMUI/AH/CIOWR /	O	Byte select/Byte select/Address hold/Write strobe for PCMCIA I/O /	
120	TDO	O	Test data output		TIC5W	I	MTU2 input capture (channel 5)	
121	PD31 / D31	I/O	} General port / Data bus	171	PA22 /	I/O	General port /	
122	PD30 / D30	I/O				WE2/DQMUL/CIORD /	O	Byte select/Byte select/Read strobe for PCMCIA I/O /
123	PD29 / D29	I/O				TIC5V	I	MTU2 input capture (channel 5)
124	PD28 / D28	I/O			172	PA13 /	I/O	General port /
125	PVcc	I	Power supply for I/O circuits		WE1/DQMLU/WE /	O	Byte select/Byte select/Write strobe for PCMCIA memory /	
126	PVss	I	Ground for I/O circuits	173	POE7	I	Port output control	
127	PD27 / D27	I/O	} General port / Data bus		PA12 /	I/O	General port /	
128	PD26 / D26	I/O				WE0/DQMLL /	O	Byte select/Byte select /
129	PD25 / D25	I/O			174	POE6	I	Port output control
130	PD24 / D24	I/O				PB4 /	I/O	General port /
131	PVcc	I	Power supply for I/O circuits		IRQ2 /	I	Interrupt requests 2 /	
132	PD23 / D23	I/O	General port / Data bus	175	POE2 /	I	Port output control /	
133	PVss	I	Ground for I/O circuits		RASL	O	RAS	
134	PD22 / D22	I/O	General port / Data bus		PA20 /	I/O	General port /	
					CS4 / RASU /	O	Chip select 4 / RAS /	
					PINT4	I	Interrupt requests 4	
				176	PVcc	I	Power supply for I/O circuits	

● T6TZ2XBG-0002 (X7376B00) SWP51 (Tone Generator)

DM: IC505, 506

PIN NO.	OUTER NO.	NAME	I/O	FUNCTION	PIN NO.	OUTER NO.	NAME	I/O	FUNCTION		
1	E5	VSS	-	Ground	106	E22	VSS	-	Ground		
2	D4	VDD1	-	Power supply +1.5 V	107	D23	VDD1	-	Power supply +1.5 V		
3	C3	CD15	I/O	Data bus of internal register	108	C24	HMA15	}	Wave memory address bus		
4	B2	CD13	I/O								
5	A1	CD14	I/O								
6	D5	CD6	I/O								
7	E6	CD2	I/O								
8	C4	CD9	I/O	Data bus of internal register	111	E23	HMA25	}	Power supply +3.3 V		
9	B3	CD11	I/O								
10	A2	CD12	I/O								
11	A3	CD10	I/O								
12	D6	CD1	I/O								
13	E7	VSS	-	Ground	112	F22	VDD3	-	}	Wave memory address bus	
14	C5	CD5	I/O								
15	B4	CD8	I/O								
16	A4	CD7	I/O								
17	D7	VSS	-	Ground	113	D24	HMA27	-			
18	C6	CD0	I/O	Data bus of internal register	114	C25	HMA0	-	}	Power supply +3.3 V	
19	E8	VSS	-	Ground	115	B26	HMA23	-			
20	D8	VDD3	-	Power supply +3.3 V	116	C26	HMA24	-			
21	B5	CD4	I/O	Data bus of internal register	117	F23	VDD3	-			
22	A5	CD3	I/O	Data bus of internal register	118	G22	HMA26	-			
23	C7	CA2	I/O								
24	B6	CA0	I/O								
25	E9	CA8	I/O								
26	D9	CA9	I/O		Address bus of internal register	119	E24	HMA30	-		
27	C8	CA5	I/O								
28	A6	CA1	I/O								
29	B7	CA3	I/O								
30	A7	CA4	I/O								
31	E10	VSS	-	Ground	120	D25	HMA28	-	}	Wave memory address bus (Lower data memory)	
32	D10	VDD1	-	Power supply +1.5 V	121	D26	HMA29	-			
33	C9	CA10	I/O	Data bus of internal register	122	G23	LMA17	-			
34	B8	CA6	I/O	Address bus of internal register	123	F24	LMA19	-			
35	A8	CA7	I/O								
36	B9	CA11	I/O								
37	E11	CA14	I/O								
38	D11	CA15	I/O		Chip select	124	H22	VSS	-		
39	C10	CA13	I/O								
40	A9	CA12	I/O								
41	B10	CSN0	I/O								
42	A10	CSN1	I/O								
43	E12	VSS	-	Ground	125	H23	VDD3	-	}	Ground	
44	D12	VDD3	-	Power supply +3.3 V	126	E25	LMA20	-			
45	C11	WRN	I/O	Write strobe	127	E26	LMA21	-			
46	B11	RDN	I/O	Read strobe	128	G24	LMA9	-			
47	A11	WAITo	I/O	Hardware wait request	129	F25	LMA18	-			
48	C12	IRQo	I/O	Interrupt request	130	J22	LMA12	-	}	Wave memory address bus (Lower data memory)	
49	B12	DREQo	I/O	DMA request	131	J23	LMA4	-			
50	E13	TCK	I/O	Test pin	132	H24	LMA6	-			
51	D13	TRST	I/O								
52	C13	VSS	-		Ground	133	F26	LMA8			-
53	A12	XO	I/O		Crystal osc. output	134	G25	LMA7	-		
54	B13	XI	I/O		Crystal osc. input	135	G26	LMA10	-		
55	A13	VDD3	-	Power supply +3.3 V	136	K22	VSS	-	}	Ground	
56	A14	SLAVE	I/O	Master/Slave select	137	K23	VDD1	-			
57	E14	TMS	I/O	Test pin	138	J24	LMA13	-			
58	D14	TDO	I/O								
59	C14	ICN	I/O		Initial clear	139	H25	LMA11			-
60	B14	RFCLKo	I/O		PLL Clock	140	H26	LMA5	-		
61	B15	PLL-TSTN	I/O		Test pin	141	J25	LMA3	-		
62	C15	PLL_BP	I/O								
63	D15	VDD3	-	Power supply +3.3 V		142	L22	LMA16	-		
64	E15	VSS	-	Ground		143	L23	LMA0	-		
65	A15	RFCLKi	I/O	PLL Clock		144	K24	LMA2	-		
66	A16	VDD1	-	Power supply +1.5 V	145	J26	LMA14	-	}	Wave memory address bus (Lower data memory)	
67	B16	TMODE	I/O	Test pin	146	K25	LMA15	-			
68	C16	PLL-AVD	I/O		Analog power supply +1.5 V (PLL)	147	K26	LMA1			-
69	D16	NC	-		Not used	148	M22	VSS			-
70	E16	NC	-		Not used	149	M23	VDD3			-
71	A17	PLL-AVS	I/O		Analog ground (PLL)	150	L24	LMA22	-		
72	B17	TEST1	I/O	Test pin	151	L25	LMA23	-			
73	A18	VSS	-		Ground	152	L26	LMA24	-		
74	C17	SY1	I/O		Sync. clock	153	M24	LMA27	-		
75	D17	VDD1	-		Power supply +1.5 V	154	M25	LMA28	-		
76	E17	VSS	-		Ground	155	N22	LMA25	-		
77	B18	KONTRGo	I/O	Key on data	156	N23	LMA26	-			
78	A19	KONTRGi	I/O								
79	C18	CK512	I/O		Master clock (512 Fs)	157	N24	LMA30	-		
80	B19	CK128	I/O		Master clock (256 Fs)	158	M26	LMA29	-		
81	D18	BCLK	I/O		Master clock (64 Fs)	159	N25	MOEN	-		
82	E18	SYO	I/O	Sync. clock	160	N26	MWEN	-			
83	C19	HMA20	I/O	Wave memory address bus	161	P26	LMD15	I/O	}	Wave memory output enable	
84	A20	HMA21	I/O								
85	B20	HMA19	I/O								
86	C20	HMA18	I/O								
87	D19	VDD3	-		Power supply +3.3 V	162	P22	VSS			-
88	E19	VSS	-	Ground	163	P23	VDD3	-	}	Wave memory write enable	
89	A21	HMA9	I/O								
90	B21	HMA7	I/O								
91	A22	HMA6	I/O								
92	D20	HMA8	I/O	Wave memory address bus	164	P24	LMD13	I/O			
93	C21	HMA10	I/O								
94	E20	HMA17	I/O								
95	D21	VDD3	-		Power supply +3.3 V	165	P25	LMD14	I/O		
96	B22	HMA11	I/O		Wave memory address bus	166	R25	LMD11	I/O		
97	A23	HMA4	I/O								
98	C22	HMA5	I/O								
99	B23	HMA13	I/O								
100	E21	VSS	-	Ground		167	R24	LMD10	I/O		
101	D22	HMA12	I/O	Wave memory address bus	168	R23	VDD3	-			
102	C23	HMA3	I/O								
103	A24	HMA14	I/O								
104	B24	HMA2	I/O								
105	A25	HMA1	I/O								

PIN NO.	OUTER NO.	NAME	I/O	FUNCTION	PIN NO.	OUTER NO.	NAME	I/O	FUNCTION		
211	AB22	VSS	-	Ground	316	AB5	VSS	-	Ground		
212	AC23	VDD1	-	Power supply +1.5 V	317	AC4	VDD1	-	Power supply +1.5 V		
213	AD24	DMAL1	O	Address bus (DIMM, SDRAM)	318	AD3	MELI6	I	} MEL wave data input		
214	AE25	DCSL2	O	Wave memory chip select (Low)	319	AE2	MELI7	I			
215	AF26	DRAS0	O	DIMM, SDRAM row address strobe (RAS signal)	320	AF1	ADLR	O	} For ADC word clock		
216	AC22	DCAS0	O	DIMM, SDRAM column address strobe (CAS signal)	321	AB4	DITo	O		Digital audio output	
217	AB21	VDD3	-	Power supply +3.3 V	322	AA5	VSS	-	Ground		
218	AD23	DCLKIN	I	DIMM, SDRAM clock input	323	AC3	AFRM	I/O	Frame signal (ABUS)		
219	AE24	DQML2	O	MASK signal	324	AD2	ACLK	I/O	Clock signal (ABUS)		
220	AF25	DCSL3	O	Wave memory chip select (Low)	325	AE1	ADIR	O	Direction signal (ABUS)		
221	AF24	DQML0	O	MASK signal	326	AD1	ADAT0	I/O	Data bus (ABUS)		
222	AC21	VDD3	-	Power supply +3.3 V	327	AA4	VDD3	-	Power supply +3.3 V		
223	AB20	VSS	-	Ground	328	Y5	ADAT9	I/O	} Data bus (ABUS)		
224	AD22	DWEN0	O	DIMM, SDRAM write enable	329	AB3	ADAT3	I/O			
225	AE23	DCLK0	O	DIMM, SDRAM clock signal	330	AC2	ADAT1	I/O			
226	AF23	DCLK1	O	DIMM, SDRAM clock enable	331	AC1	ADAT2	I/O			
227	AC20	DCLKE	O	DIMM, SDRAM clock enable	332	Y4	ADAT10	I/O			
228	AD21	HMD13	I/O	Wave memory data bus (Upper data memory)	333	AA3	ADAT6	I/O	} Ground		
229	AB19	VSS	-	Ground	334	W5	VSS	-		Power supply +3.3 V	
230	AC19	VDD3	-	Power supply +3.3 V	335	W4	VDD3	-	} Data bus (ABUS)		
231	AE22	HMD15	I/O	} Wave memory data bus (Upper data memory)	336	AB2	ADAT4	I/O			
232	AF22	HMD14	I/O		Power supply +1.5 V	337	AB1	ADAT5		I/O	
233	AD20	HMD10	I/O		Power supply +3.3 V	338	Y3	ADAT11		I/O	
234	AE21	HMD12	I/O		Power supply +1.5 V	339	AA2	ADAT7		I/O	
235	AB18	VDD1	-		Power supply +3.3 V	340	V5	ADAT14	I/O		
236	AC18	VDD3	-	} Wave memory data bus (Upper data memory)	341	V4	ADAT15	I/O			
237	AD19	HMD7	I/O		Power supply +1.5 V	342	W3	ADAT13	I/O		
238	AF21	HMD11	I/O		Power supply +3.3 V	343	AA1	ADAT8	I/O		
239	AE20	HMD9	I/O		Power supply +1.5 V	344	Y2	ADAT12	I/O		
240	AF20	HMD8	I/O		Power supply +3.3 V	345	Y1	TDI	I	Test pin	
241	AB17	VSS	-	Ground	346	U5	VSS	-	Ground		
242	AC17	VDD1	-	Power supply +1.5 V	347	U4	VDD1	-	Power supply +1.5 V		
243	AD18	HMD4	I/O	} Wave memory data bus (Upper data memory)	348	V3	HRD13	I/O	} DRAM data bus		
244	AE19	HMD6	I/O		Power supply +1.5 V	349	W2	HRD15		I/O	
245	AF19	HMD5	I/O		Power supply +3.3 V	350	W1	HRD14		I/O	
246	AE18	HMD3	I/O		Power supply +1.5 V	351	V2	HRD12		I/O	
247	AB16	VSS	-		Ground	352	T5	HRD7		I/O	
248	AC16	VSS	-	Ground	353	T4	HRD6	I/O			
249	AD17	HMD1	I/O	} Wave memory data bus (Upper data memory)	354	U3	HRD10	I/O			
250	AF18	HMD2	I/O		Power supply +1.5 V	355	V1	HRD11	I/O		
251	AE17	HMD0	I/O		Power supply +3.3 V	356	U2	HRD9	I/O		
252	AF17	DCSH0	O		Wave memory chip select (High)	357	U1	HRD8	I/O		
253	AB15	VSS	-		Ground	358	R5	VSS	-	Ground	
254	AC15	VDD3	-	Power supply +3.3 V	359	R4	VDD3	-	Power supply +3.3 V		
255	AD16	DCSH1	O	Wave memory chip select (High)	360	T3	HRD5	I/O	} DRAM data bus		
256	AE16	DQMH3	O	MASK signal	361	T2	HRD4	I/O			
257	AF16	DQMH1	O	MASK signal	362	T1	HRD3	I/O			
258	AD15	DMAH14	O	} Address bus (DIMM, SDRAM)	363	R3	HRD2	I/O			
259	AE15	DMAH13	O		Power supply +3.3 V	364	R2	HRD1		I/O	
260	AB14	VSS	-		Power supply +3.3 V	365	P5	VDD3	-	Power supply +3.3 V	
261	AC14	VSS	-		Ground	366	P4	HRD0	I/O	DRAM data bus	
262	AD14	DMAH11	O		Ground	367	P3	RWEN	O	DRAM write enable	
263	AF15	DMAH12	O	} Address bus (DIMM, SDRAM)	368	R1	RQML	O	MASK signal (SDRAM)		
264	AE14	DMAH10	O		Power supply +3.3 V	369	P2	RCAS	O	DRAM column address strobe (CAS signal)	
265	AF14	DMAH9	O		Power supply +3.3 V	370	P1	RRAS	O	DRAM row address strobe (RAS signal)	
266	AF13	DMAH8	O		Power supply +3.3 V	371	N1	RA13	O	DRAM address bus	
267	AB13	VDD3	-		Power supply +3.3 V	372	N5	VDD3	-	Power supply +3.3 V	
268	AC13	VDD3	-	Power supply +3.3 V	373	N4	VDD3	-	Power supply +3.3 V		
269	AD13	DMAH6	O	} Address bus (DIMM, SDRAM)	374	N3	RA10	O	} DRAM address bus		
270	AE13	DMAH7	O		Power supply +3.3 V	375	N2	RA12		O	
271	AE12	DMAH4	O		Power supply +3.3 V	376	M2	RA1		O	
272	AD12	DMAH3	O		Ground	377	M3	RA2		O	
273	AC12	VDD3	-		Power supply +3.3 V	378	M4	VDD3		-	Power supply +3.3 V
274	AB12	VSS	-	Ground	379	M5	VSS	-	Ground		
275	AF12	DMAH5	O	} Address bus (DIMM, SDRAM)	380	M1	RA0	O	} DRAM address bus		
276	AF11	DMAH2	O		Power supply +3.3 V	381	L1	RA3		O	
277	AE11	DMAH1	O		Power supply +3.3 V	382	L2	RA4		O	
278	AD11	DMAH0	O		Power supply +1.5 V	383	L3	RA5		O	
279	AC11	VSS	-		Ground	384	L4	VSS		-	Ground
280	AB11	VSS	-	Ground	385	L5	VSS	-	Ground		
281	AF10	DRAS1	O	DIMM, SDRAM row address strobe (RAS signal)	386	K1	RA6	O	} DRAM address bus		
282	AE10	DCSH2	O	Wave memory chip select (High)	387	K2	RA7	O			
283	AF9	DQMH2	O	MASK signal	388	J1	RA9	O			
284	AD10	DCSH3	O	Wave memory chip select (High)	389	K3	RA8	O			
285	AC10	VDD1	-	Power supply +1.5 V	390	K4	VDD1	-		Power supply +1.5 V	
286	AB10	VSS	-	Ground	391	K5	VSS	-	Ground		
287	AE9	DQMH0	O	MASK signal	392	J2	RA11	O	DRAM address bus		
288	AF8	DWEN1	O	DIMM, SDRAM write enable	393	H1	RCLK	O	SDRAM clock signal		
289	AD9	DCAS1	O	DIMM, SDRAM column address strobe (CAS signal)	394	J3	RCLKE	O	SDRAM clock enable		
290	AE8	DCLK2	O	DIMM, SDRAM clock signal	395	H2	RCLKIN	I	SDRAM, DRAM clock input		
291	AC9	VDD3	-	Power supply +3.3 V	396	J4	VDD3	-	Power supply +3.3 V		
292	AB9	VDD1	-	Power supply +1.5 V	397	J5	VDD1	-	Power supply +1.5 V		
293	AD8	DCLK3	O	DIMM, SDRAM clock signal	398	H3	RQMH	O	MASK signal (SDRAM)		
294	AF7	MEL00	O	} MEL wave data output	399	G1	LRD15	I/O	} DRAM data bus (Lower data)		
295	AE7	MEL01	O		Power supply +3.3 V	400	G2	LRD14		I/O	
296	AD7	MEL02	O		Ground	401	G3	LRD13		I/O	
297	AC8	VDD3	-		Power supply +3.3 V	402	H4	VDD3		-	Power supply +3.3 V
298	AB8	VSS	-		Ground	403	H5	VSS		-	Ground
299	AF6	MEL03	O	} MEL wave data output	404	F1	LRD12	I/O	} DRAM data bus (Lower data)		
300	AE6	MEL04	O		Power supply +3.3 V	405	F2	LRD11		I/O	
301	AF5	MEL05	O		Power supply +3.3 V	406	E1	LRD8		I/O	
302	AC7	MEL06	O		Power supply +1.5 V	407	G4	VDD3		-	Power supply +3.3 V
303	AD6	MEL07	O		DIMM, SDRAM clock signal	408	F3	LRD10		I/O	DRAM data bus (Lower data)
304	AB7	WCLK0	O	} For DAC word clock	409	G5	VDD3	-	Power supply +3.3 V		
305	AC6	WCLK1	O		E bus interrupt request	410	F4	LRD9	I/O	} DRAM data bus (Lower data)	
306	AE5	EIRQ	O		E bus initial clear	411	E2	LRD7	I/O		
307	AF4	EICN	O		E bus data	412	D1	LRD5	I/O		
308	AD5	ESDA	I/O		E bus clock	413	E3	LRD6	I/O		
309	AE4	ESCL	I/O	} MEL wave data input	414	D2	LRD4	I/O	} Ground		
310	AB6	MELI0	I		Power supply +3.3 V	415	F5	VSS		-	Ground
311	AC5	MELI1	I		Ground	416	E4	VSS		-	Ground
312	AD4	MELI2	I		} MEL wave data input	417	D3	LRD3		I/O	} DRAM data bus (Lower data)
313	AF3	MELI3	I			Power supply +3.3 V	418	C1		LRD2	
314	AE3	MELI4	I	Power supply +1.5 V		419	C2	LRD1	I/O		
315	AF2	MELI5	I	Ground		420	B1	LRD0	I/O		

● LC4256V-75TN100 (X6046B0R) CPLD (MAT)

DM: IC205

Pin No.	NAME	I/O	FUNCTION/CONNECTION	Pin No.	NAME	I/O	FUNCTION/CONNECTION	
1	GND	-	DGND	51	GND	-	DGND	
2	TDI	I	for CPLD data writing (JTAG pin)	52	TMS	-	for CPLD data communication (JTAG pin)	
3	DGA_AUDIO_IN	O	Digital audio signal output	53	MELO_0	O	Data for PLAYBACK tracks1 and 2	
4	I/O		(to +3.3V _D)	54	I/O		(to +3.3V _D)	
5	DGA_OUT	I	Digital audio signal input	55	MELO_2	O	Data for PLAYBACK tracks 3 and 4	
6	I/O		(to +3.3V _D)	56	MELI_0	I	Data for RECORD tracks 1 and 2	
7	GND	-	DGND	57	GND	-	DGND	
8	I/O		(to +3.3V _D)	58	I/O		} (to +3.3V _D)	
9	IDERD_O	I	IDE READ signal (active-low)	59	I/O			
10	IDEWR_O	I	IDE WRITE signal (active-low)	60	I/O			
11	IDEMACK_O	I	DMA ACKNOWLEDGE signal (active-low)	61	I/O			
12	CLOCK_INPUT	I	DMA REQUEST signal (active-low)	62	I		} (to +3.3V _D)	
13	VCCO	-	Power supply +3.3V _D	63	VCCO	-		Power supply +3.3V _D
14	DMACLR	I	DMA CLEAR signal (active-low)	64	I/O		} (to +3.3V _D)	
15	I/O		} (to +3.3V _D)	65	I/O			
16	I/O							
17	I/O							
18	GND	-	DGND	66	I/O		} (to +3.3V _D)	
19	HDIRQ	I	INTERRUPT signal (HDD to CPU) (active-high)	67	DGAMCLK	O		System master clock (22.5792MHz)
20	XHDIRQ	O	INTERRUPT signal (HDD to CPU) (active-low)	68	GND	-	DGND	
21	I/O		} (to +3.3V _D)	69	DGAWCLK	O	System word clock (44.1kHz)	
22	I/O							
23	FS64DGA	I		Bit clock for data between DGA and MAT	70	I/O		(to +3.3V _D)
24	TCK	I	Clock for CPLD data communication (JTAG pin)	71	IDEMARQ512D	O	IDE DMA request	
25	VCC	-	Power supply +3.3V _D	72	DMAERR	O	(Not used)	
26	GND	-	DGND	73	I	I	(to DGND)	
27	I		} (to +3.3V _D)	74	TDD	O	for CPLD data communication	
28	I/O							
29	I/O							
30	I/O							
31	I/O							
32	GND	-		DGND	75	VCCO	-	Power supply +3.3V _D
33	VCCO	-		Power supply +3.3V _D	76	GND	-	DGND
34	I/O		} (to +3.3V _D)	77	I		(to +3.3V _D)	
35	I/O							
36	I/O							
37	I/O							
38	CK512	I	Master clock (22.5792KHz)	78	I/O		(to DGND)	
39	FS128	I	Bit clock for data between SWP50 and MAT (11.2894MHz)	79	WCLK1	O	Word clock for DAC (Not used)	
40	I/O		} (to +3.3V _D)	80	I/O		(to DGND)	
41	I/O							
42	I/O							
43	I/O							
44	I/O		} (to +3.3V _D)	81	WCLK0	O	Word clock for DAC (Not used)	
45	VCCO	-		Power supply +3.3V _D	82	GND	-	DGND
46	GND	-		DGND	83	VCCO	-	Power supply +3.3V _D
47	I/O		} (to +3.3V _D)	84	ADLR	O	LR signal for DAC (Not used)	
48	I/O							
49	I/O							
50	I/O							
				85	I/O		(to DGND)	
				86	FS640UT	O	Maste clock for DAC (Not used)	
				87	I/O/GOE1		(to DGND)	
				88	FS	I	Sampling frequency (44.1kHz)	
				89	FS256	I	256FS (11.2896MHz)	
				90	VCCO	-	Power supply +3.3V _D	
				91	I/O/GOE0		} (to +3.3V _D)	
				92	I/O			
				93	I/O			
				94	I/O			
				95	VCCO	-	Power supply +3.3V _D	
				96	GND	-	Ground	
				97	I/O		} (to +3.3V _D)	
				98	I/O			
				99	I/O			
				100	IDMARQ_0512HDL	O	Output in case that the DMA request signal is negated by the rising or falling edge of 512FS. (Not used.)	

● YGV628B-VZ (X6356B00) RGB CONTROLLER AVDP7

DM: IC402

PIN NO.	NAME	I/O	FUNCTION	PIN NO.	NAME	I/O	FUNCTION	
1	A23	I	CPU address bus	89	SA13	O	Video memory address bus	
2	A22	I		90	VDD	-	Digital power supply +3.3 V	
3	A21	I		91	SA11	O	Video memory address bus	
4	A20	I	92	SA12	O			
5	VDD	-	93	SA9	O			
6	A19	I	Digital power supply +3.3 V	94	SA10	O	Digital ground	
7	VSS	-	Digital ground	95	SA8	O		
8	A18	I	CPU address bus	96	SA0	O		
9	A17	I		97	VSS	-	Digital ground	
10	A16	I		CPU address bus	98	SA1	O	Video memory address bus
11	A15	I	99		SA6	O		
12	A14	I	100		SA7	O		
13	A13	I	CPU address bus	101	VDD	-	Digital power supply +3.3 V	
14	A12	I		102	SA2	O	Video memory address bus	
15	A11	I		103	SA5	O		
16	A10	I	104	SA3	O			
17	A9	I	CPU address bus	105	SA4	O	Digital ground	
18	A8	I		106	VSS	-		
19	VDD	-		Digital power supply +3.3 V	107	GCK2OUT		O
20	VSS	-	Digital ground	108	VDD	-	Digital power supply +3.3 V	
21	A7	I	CPU address bus	109	DRO0	O	Digital R signal output	
22	A6	I		110	DRO1	O		
23	A5	I		111	DRO2	O		
24	A4	I	CPU address bus	112	DRO3	O	Digital G signal output	
25	A3	I		113	DRO4	O		
26	A2	I		114	DRO5	O		
27	A1	I	Write strobe input	115	DGO0	O	Digital ground	
28	WRH_N	I		116	DGO1	O		
29	WRL_N	I		117	VSS	-		
30	RD_N	I	Read pulse input	118	DGO2	O	Digital G signal output	
31	RESET_N	I	Reset input	119	DGO3	O		
32	VSS	-	Digital ground	120	VDD	-	Digital power supply +3.3 V	
33	CS_N	I	Chip select	121	DGO4	O	Digital G signal output	
34	VDD	-	Digital power supply +3.3 V	122	DGO5	O		
35	DREQ_N	O	Direct memory access	123	DBO0	O	Digital B signal output	
36	INT_N	O	Interrupt	124	DBO1	O		
37	READY_N	O	CPU bus ready	125	DBO2	O		
38	WAIT_N	O	CPU bus wait	126	DBO3	O	Digital ground	
39	D15	I/O	CPU data bus	127	VSS	-		
40	D14	I/O		128	DBO4	O		
41	D13	I/O		129	DBO5	O		
42	D12	I/O	CPU data bus	130	YS_N	O	YS signal output	
43	VSS	-		Digital ground	131	BLANK_N	O	Non-display interval output
44	D11	I/O		CPU data bus	132	VDD	-	Digital power supply +3.3 V
45	D10	I/O	CPU data bus	133	DACVSS	-	DAC analog ground	
46	VDD	-		Digital power supply +3.3 V	134	R	O	Analog R signal output
47	D9	I/O		CPU data bus	135	G	O	Analog G signal output
48	D8	I/O	136		B	O	Analog B signal output	
49	D7	I/O	CPU data bus		137	IREF	-	DAC reference electric-current input
50	D6	I/O		138	DACVDD	-	DAC analog power supply +3.3 V	
51	D5	I/O		CPU data bus	139	TEST2_N	I	Test pin
52	D4	I/O	140		TEST1_N	I		
53	VSS	-	Digital ground		141	TEST0_N	I	
54	D3	I/O	CPU data bus	142	CSYNC_N	O	Horizontal synchronized signal / Compound synchronized signal output	
55	D2	I/O		143	VSYNC_N	O	Vertical synchronized signal output	
56	D1	I/O		CPU data bus	144	GCK1OUT	O	Dot clock output 1
57	D0	I/O	145		VDD	-	Digital power supply +3.3 V	
58	VDD	-	Digital power supply +3.3 V		146	GCK2IN	I	Dot clock input 2
59	SDQ0	I/O	Video memory data bus	147	DRIO	I	Digital R signal input	
60	SDQ15	I/O		148	VSS	-	Digital ground	
61	VSS	-		Digital ground	149	DR11	I	Digital R signal input
62	SDQ1	I/O	Video memory data bus	150	DR12	I		
63	SDQ14	I/O		151	DR13	I		
64	SDQ2	I/O		Video memory data bus	152	DR14	I	Digital G signal input
65	SDQ13	I/O	153		DR15	I		
66	SDQ3	I/O	Video memory data bus		154	DG10	I	
67	VSS	-		Digital ground	155	DG11	I	
68	SDQ12	I/O		Video memory data bus	156	DG12	I	
69	VDD	-	Digital power supply +3.3 V	157	DG13	I	Digital power supply +3.3 V	
70	SDQ4	I/O	Video memory data bus	158	VDD	-		
71	SDQ11	I/O		159	DG14	I		Digital G signal input
72	SDQ5	I/O		Video memory data bus	160	VSS	-	Digital ground
73	SDQ10	I/O	161		DG15	I	Digital G signal input	
74	VSS	-	Digital ground		162	DB10	I	Digital B signal input
75	SDQ6	I/O	Video memory data bus	163	DB11	I		
76	SDQ9	I/O		164	DB12	I		
77	SDQ7	I/O		Video memory data bus	165	DB13	I	Digital power supply +3.3 V
78	SDQ8	I/O	166		DB14	I		
79	VDD	-	Digital power supply +3.3 V		167	DB15	I	
80	LDQM	O	Video memory data mask output	168	HSIN_N	I	Horizontal synchronized signal input	
81	VSS	-	Digital ground	169	VSIN_N	I	Vertical synchronized signal input	
82	WE_N	O	Video memory write enable	170	VDD	-	Digital power supply +3.3 V	
83	UDQM	O	Video memory data mask output	171	VSS	-	Digital ground	
84	CAS_N	O	Video memory column address strobe output	172	GCK1IN	I	Dot clock input 1	
85	SDCKOUT	O	Video memory clock output	173	SYCKIN	I	System clock input	
86	RAS_N	O	Video memory row address strobe output	174	PLLVD	-	PLL analog power supply +3.3 V	
87	VSS	-	Digital ground	175	PLLSS	-	PLL analog ground	
88	SCS_N	O	Video memory chip enable	176	FILTER	-	Filter connect pin for PLL	

● ISP1761BE (X9073A00) HI-SPEED USB OTG CONTROLLER

DM: IC207

PIN NO.	NAME	I/O	FUNCTION	PIN NO.	NAME	I/O	FUNCTION
1	OC3_N	I	Port 3 analog (5 V input) and digital overcurrent input Input, 3.3 V tolerant	75	VCC(I/O)	I/O	Digital supply; 1.65 V to 3.6 V; Connect a 100 nF decoupling capacitor
2	REF5V	I	5 V reference input for analog OC detector; Connect a 100 nF decoupling capacitor	76	DATA28	I/O	Data bit 28 input and output
3	ID	I	ID input for detection of the default host or peripheral setting when port 1 is in the OTG mode	77	DATA29	I/O	Bidirectional pad, push-pull input, three-state output, 4 mA output drive, 3.3 V tolerant Data bit 29 input and output
4	GND		Input, 3.3 V tolerant	78	DATA30	I/O	Bidirectional pad, push-pull input, three-state output, 4 mA output drive, 3.3 V tolerant Data bit 30 input and output
5	VREG(1V8)	O	Analog ground	79	GND		Bidirectional pad, push-pull input, three-state output, 4 mA output drive, 3.3 V tolerant Digital ground
6	VCC(5V0)	I	Core power output (1.8 V); Internal 1.8 V for the digital core; Used for decoupling; Connect a 100 nF capacitor	80	DATA31	I/O	Data bit 31 input and output
7	VCC(5V0)	I	Input to internal regulators (3.0 V to 5.5 V); Connect a 100 nF decoupling capacitor	81	TEST		Bidirectional pad, push-pull input, three-state output, 4 mA output drive, 3.3 V tolerant
8	GND		Oscillator ground	82	A1	I	Connect to ground
9	VREG(3V3)	O	Regulator output (3.3 V); For decoupling only; Connect a 100 nF capacitor and a 4.7 mF to 10 mF capacitor	83	VCC(I/O)	I/O	Address pin 1
10	VCC(I/O)	I/O	Digital supply; 1.65 V to 3.6 V; Connect a 100 nF decoupling capacitor	84	A2	I	Input, 3.3 V tolerant
11	XTAL1	I	12 MHz crystal connection input; Connect to ground if an external clock is used	85	VREG(1V8)	O	Digital supply; 1.65 V to 3.6 V; Connect a 100 nF decoupling capacitor
12	XTAL2	O	12 MHz crystal connection output	86	A3	I	Address pin 2
13	CLKIN	I	12 MHz oscillator or clock input; Connect to VCC(I/O) when not in use 3.3 V tolerant	87	A4	I	Input, 3.3 V tolerant
14	GND		Digital ground	88	GND		Address pin 3
15	GND		RREF1 ground	89	A5	I	Input, 3.3 V tolerant
16	RREF1	I	Reference resistor connection; Connect a 12kΩ ± 1% resistor between this pin and the RREF1 ground	90	GND		Core ground
17	GND		Analog ground for port 1	91	A6	I	Address pin 4
18	DM1	I/O	Downstream data minus port 1	92	A7	I	Input, 3.3 V tolerant
19	GND		Analog ground	93	A8	I	Address pin 5
20	DP1	I/O	Downstream data plus port 1	94	VCC(I/O)	I/O	Input, 3.3 V tolerant
21	PSW1_N	O	Power switch port 1, active LOW	95	A9	I	Address pin 6
22	GND		Output pad, push-pull open-drain, 8 mA output drive, 5 V tolerant	96	A10	I	Input, 3.3 V tolerant
23	RREF2	I	RREF2 ground	97	A11	I	Address pin 7
24	GND		Reference resistor connection; Connect a 12kΩ ± 1% resistor between this pin and the RREF2 ground	98	A12	I	Input, 3.3 V tolerant
25	DM2	I/O	Analog ground for port 2	99	GND		Address pin 8
26	GND		Downstream data minus port 2	100	A13	I	Input, 3.3 V tolerant
27	DP2	I/O	Analog ground	101	A14	I	Address pin 9
28	PSW2_N	O	Downstream data plus port 2	102	A15	I	Input, 3.3 V tolerant
29	GND		Power switch port 2, active LOW	103	A16	I	Address pin 10
30	RREF3	I	Output pad, push-pull open-drain, 8 mA output drive, 5 V tolerant	104	VCC(I/O)	I/O	Input, 3.3 V tolerant
31	GND		RREF3 ground	105	A17	I	Address pin 11
32	DM3	I/O	Reference resistor connection; Connect a 12kΩ ± 1% resistor between this pin and the RREF3 ground	106	CS_N	I	Input, 3.3 V tolerant
33	GND		Analog ground for port 3	107	RD_N	I	Digital voltage; 1.65 V to 3.6 V; Connect a 100 nF decoupling capacitor
34	DP3	I/O	Downstream data minus port 3	108	WR_N	I	Address pin 12
35	PSW3_N	O	Analog ground	109	GND		Input, 3.3 V tolerant
36	GND		Downstream data plus port 3	110	VBAT_ON_N	O	Write enable; Active LOW
37	DATA0	I/O	Power switch port 3, active LOW	111	DC_IRQ	O	Input, 3.3 V tolerant
38	DATA1	I/O	Output pad, push-pull open-drain, 8 mA output drive, 5 V tolerant	112	HC_IRQ	O	Digital ground
39	DATA2	I/O	Digital ground	113	DC_DREQ	O	Data bit 0 input and output
40	VCC(I/O)	I/O	Bidirectional pad, push-pull input, three-state output, 4 mA output drive, 3.3 V tolerant	114	HC_DREQ	O	Bidirectional pad, push-pull input, three-state output, 4 mA output drive, 3.3 V tolerant
41	DATA3	I/O	Digital supply; 1.65 V to 3.6 V; Connect a 100 nF decoupling capacitor	115	VCC(I/O)	I/O	Bidirectional pad, push-pull input, three-state output, 4 mA output drive, 3.3 V tolerant
42	DATA4	I/O	Data bit 3 input and output	116	HC_DACK	I	Digital voltage; 1.65 V to 3.6 V; Connect a 100 nF decoupling capacitor
43	DATA5	I/O	Bidirectional pad, push-pull input, three-state output, 4 mA output drive, 3.3 V tolerant	117	DC_DACK	I	Host Controller DMA request acknowledgment; When not in use, connect to VCC(I/O) through a 10 kΩ pull-up resistor
44	GND		Bidirectional pad, push-pull input, three-state output, 4 mA output drive, 3.3 V tolerant	118	VREG(1V8)	O	Input, 3.3 V tolerant
45	DATA6	I/O	Digital ground	119	HC_SUSPEND	I/O	Peripheral Controller DMA request acknowledgment; When not in use, connect to VCC(I/O) through a 10 kΩ pull-up resistor
46	DATA7	I/O	Data bit 6 input and output	120	DC_SUSPEND	I/O	Input, 3.3 V tolerant
47	DATA8	I/O	Bidirectional pad, push-pull input, three-state output, 4 mA output drive, 3.3 V tolerant	121	GND		Core power output (1.8 V); Internal 1.8 V for the digital core; Used for decoupling; Connect a 100 nF capacitor
48	VCC(I/O)	I/O	Bidirectional pad, push-pull input, three-state output, 4 mA output drive, 3.3 V tolerant	122	RESET_N	I	Host Controller suspend and wake-up; Three-state suspend output (active LOW) and wake-up input circuits are connected together
49	DATA9	I/O	Digital supply; 1.65 V to 3.6 V; Connect a 100 nF decoupling capacitor	123	GND		• HIGH = output is three-state; ISP1761 is in suspend mode.
50	VREG(1V8)	O	Data bit 9 input and output	124	C_A	I/O	• LOW = output is LOW; ISP1761 is not in suspend mode.
51	DATA10	I/O	Bidirectional pad, push-pull input, three-state output, 4 mA output drive, 3.3 V tolerant	125	C_A	I/O	Connect to VCC(I/O) through a 10 kΩ pull-up resistor
52	DATA11	I/O	Digital ground	126	VCC(C_IN)	I	Peripheral Controller suspend and wake-up; Three-state suspend output (active LOW) and wake-up input circuits are connected together.
53	GND		Data bit 10 input and output	127	OC1_NVBUS	I/O,I	• HIGH = output is three-state; ISP1761 is in suspend mode.
54	DATA12	I/O	Bidirectional pad, push-pull input, three-state output, 4 mA output drive, 3.3 V tolerant				• LOW = output is LOW; ISP1761 is not in suspend mode.
55	GND		Data bit 11 input and output				Connect to VCC(I/O) through an external 10 kΩ pull-up resistor
56	DATA13	I/O	Bidirectional pad, push-pull input, three-state output, 4 mA output drive, 3.3 V tolerant				Output pad, open-drain, 4 mA output drive, 3.3 V tolerant
57	DATA14	I/O	Digital ground				Digital ground
58	DATA15	I/O	Data bit 12 input and output				Core ground
59	VCC(I/O)	I/O	Bidirectional pad, push-pull input, three-state output, 4 mA output drive, 3.3 V tolerant				External power-up reset; Active LOW
60	DATA16	I/O	Digital supply; 1.65 V to 3.6 V; Connect a 100 nF decoupling capacitor				Input, 3.3 V tolerant
61	DATA17	I/O	Data bit 13 input and output				Analog ground
62	DATA18	I/O	Bidirectional pad, push-pull input, three-state output, 4 mA output drive, 3.3 V tolerant				Charge pump capacitor input; Connect a 220 nF capacitor between this pin and pin 125
63	GND		Data bit 14 input and output				Charge pump capacitor input; Connect a 220 nF capacitor between this pin and pin 124
64	DATA19	I/O	Bidirectional pad, push-pull input, three-state output, 4 mA output drive, 3.3 V tolerant				Charge pump input; Connect to 3.3 V
65	DATA20	I/O	Digital ground				This pin has multiple functions:
66	DATA21	I/O	Data bit 15 input and output				• Port 1 OC1_N detection when port 1 is configured for host functionality and an external power switch is used; Connect to VCC(I/O) through a 10 kΩ resistor
67	VCC(I/O)	I/O	Bidirectional pad, push-pull input, three-state output, 4 mA output drive, 3.3 V tolerant				• VBUS out when internal charge pump is used and port 1 is configured for the host functionality; Maximum 50 mA current capability; Only for port 1
68	DATA22	I/O	Digital supply; 1.65 V to 3.6 V; Connect a 100 nF decoupling capacitor				• VBUS input detection when port 1 is defined for the peripheral functionality.
69	DATA23	I/O	Bidirectional pad, push-pull input, three-state output, 4 mA output drive, 3.3 V tolerant				Input, 3.3 V tolerant
70	DATA24	I/O	Data bit 16 input and output				Port 2 analog (5 V input) and digital overcurrent input;
71	GND		Bidirectional pad, push-pull input, three-state output, 4 mA output drive, 3.3 V tolerant				If not used, connect to VCC(I/O) through a 10 kΩ resistor
72	DATA25	I/O	Digital ground				Input, 3.3 V tolerant
73	DATA26	I/O	Data bit 17 input and output				
74	DATA27	I/O	Bidirectional pad, push-pull input, three-state output, 4 mA output drive, 3.3 V tolerant				

● S1L52502F24J200 (X2688A0R) GATE ARRAY

DM: IC203

PIN NO.	NAME	I/O	FUNCTION	PIN NO.	NAME	I/O	FUNCTION	
1	LVDD		Power supply +3.3V	105	HVDD		Power supply +5V	
2	XDACK	I	CPU DMA acknowledge	106	LEDD0	O	Port/Test output	
3	XDRACK	I	CPU DREQ request acknowledge	107	LEDD1	O		
4	XDREQ	O	CPU DMA request	108	LEDD2	O		
5	ATPGEN	I	ATPG test input	109	LEDD3	O		
6	VSS		Ground	110	VSS		Ground	
7	ENCA0	I	Encoder0 A input	111	LVDD		Power supply +3.3V	
8	ENCB0	I	Encoder0 B input	112	XTA22I	I	XTAL input terminal	
9	ENCA1	I	Encoder1 A input	113	VSS		Ground	
10	ENCB1	I	Encoder1 B input	114	XTA22O	O	XTAL output terminal	
11	HVDD		Power supply +5V	115	LVDD		Power supply +3.3V	
12	ENCA2	I	Encoder2 A input	116	HVDD		Power supply +5V	
13	ENCB2	I	Encoder2 B input	117	LEDD4	O	Port/Test output	
14	ENCA3	I	Encoder3 A input	118	LEDD5	O		
15	ENCB3	I	Encoder3 B input	119	LEDD6	O		
16	VSS		Ground	120	LEDD7	O		
17	ENCA4	I	Encoder4 A input	121	VSS		Ground	
18	ENCB4	I	Encoder4 B input	122	VCOI	I	VCO clock input	
19	ENCA5	I	Encoder5 A input	123	HVDD		Power supply +5V	
20	ENCB5	I	Encoder5 B input	124	PDOOUT	O	PLL phase comparator output	
21	HVDD		Power supply +5V	125	VSS		Ground	
22	TSTEN	I	Test mode change	126	XRESET	I	Reset signal input	
23	XIDCS0	O	IDE chip select	127	EXTWCI	I	External synchronization WC input	
24	XIDCS1	O						
25	XIDDOE	O	IDE bus buffer DIR signal	128	SDIN	I	Digital sound input	
26	VSS		Ground	129	SDOUT	O	Digital sound output	
27	HVDD		Power supply +5V	130	HVDD		Power supply +5V	
28	XIDWR	O	IDE write signal	131	XDSPCS0	O	DSP6 chip select	
29	XIDRD	O	IDE read signal	132	XDSPCS2	O	DSP chip select (reserve)	
30	XIDMACK	O	IDE DMA acknowledge	133	XDSPCS1	O	DSP7 chip select	
31	IDMARQ	I	IDE DMA request	134	VSS		Ground	
32	VSS		Ground	135	AUDIOIN0	I	Audio data input	
33	IDD0	I/O	IDE data bus	136	AUDIOIN1	I		
34	IDD1	I/O			137	AUDIOOUT0	O	Audio data output
35	IDD2	I/O		138	LVDD		Power supply +3.3V	
36	IDD3	I/O	Power supply +5V	139	AUDIOOUT1	O	Audio data output	
37	HVDD				140	AUDIOOUT2		O
38	IDD4	I/O	IDE data bus	141	AUDIOOUT3	O	Ground	
39	IDD5	I/O			142	VSS		
40	IDD6	I/O	Ground	143	AUDIOOUT4	O	Audio data output	
41	IDD7	I/O			144	AUDIOOUT5		O
42	VSS			145	AUDIOOUT6	O		
43	IDD8	I/O	IDE data bus	146	LVDD		Power supply +3.3V	
44	IDD9	I/O			147	HVDD		Power supply +5V
45	IDD10	I/O	Power supply +5V	148	CK512	O	FS512 clock	
46	IDD11	I/O			149	FS256	O	FS256 clock
47	HVDD		IDE data bus	150	FS128	O	FS128 clock	
48	IDD12	I/O			151	VSS		Ground
49	IDD13	I/O	Ground	152	XFS64	O	FS64 clock (reverse)	
50	IDD14	I/O			153	ALRCK	O	System WC (FS)
51	IDD15	I/O	Power supply +5V	154	XSSYNC	O	DSP synchronizing signal output	
52	VSS				155	HVDD		Power supply +5V
53	LVDD		Power supply +3.3V	156	VSS		Ground	
54	SDRD0	I/O	SDRAM data bus	157	LVDD		Power supply +3.3V	
55	SDRD1	I/O			158	HVDD		Power supply +5V
56	SDRD2	I/O	Ground	159	XLDCS0	O	Data buffer enable	
57	SDRD3	I/O			160	XLDCS1	O	LCD driver chip select
58	VSS			161	XLDCS1	O		
59	SDRD4	I/O	SDRAM data bus	162	VSS		Ground	
60	SDRD5	I/O			163	CD0	I/O	CPU data bus
61	SDRD6	I/O	Power supply +3.3V	164	CD1	I/O		
62	SDRD7	I/O			165	CD2	I/O	
63	LVDD		SDRAM data bus	166	CD3	I/O	Power supply +3.3V	
64	SDRD8	I/O			167	LVDD		
65	SDRD9	I/O	Ground	168	CD4	I/O	CPU data bus	
66	SDRD10	I/O			169	CD5		I/O
67	SDRD11	I/O	SDRAM data bus	170	CD6	I/O	CPU data bus	
68	VSS				171	CD7		I/O
69	SDRD12	I/O	Ground	172	VSS		Ground	
70	SDRD13	I/O			173	CD8		I/O
71	SDRD14	I/O	SDRAM data bus	174	CD9	I/O	CPU data bus	
72	SDRD15	I/O			175	CD10		I/O
73	LVDD		Power supply +3.3V	176	CD11	I/O	Power supply +3.3V	
74	SDRA0	O	SDRAM address output	177	LVDD			
75	SDRA1	O			178	CD12	I/O	CPU data bus
76	SDRA2	O	Ground	179	CD13	I/O		
77	SDRA3	O			180	CD14	I/O	
78	VSS		Power supply +3.3V	181	CD15	I/O	Ground	
79	LVDD			182	VSS			
80	SDRA4	O	SDRAM address output	183	LVDD		Power supply +3.3V	
81	SDRA5	O			184	CA1	I	CPU address input
82	SDRA6	O	Ground	185	CA2	I		
83	SDRA7	O			186	CA3	I	
84	VSS			187	CA4	I		
85	SDRA8	O	SDRAM address output	188	VSS		Ground	
86	SDRA9	O			189	CA5	I	CPU address input
87	SDRA10	O	Power supply +3.3V	190	CA6	I		
88	SDRA11	O			191	CA7	I	
89	LVDD		SDRAM address output	192	CA12	I		
90	SDRA12	O	SDRAM address output	193	LVDD		Power supply +3.3V	
91	SDRA13	O			194	CA13	I	CPU address input
92	XSDRWE	O	SDRAM write signal	195	CA16	I		
93	XSDRRAS	O	SDRAM row address strobe	196	XCCS5	I	CPU chip select	
94	VSS		Ground	197	XCCS6	I		
95	XSDRCAS	O	SDRAM column address strobe	198	VSS		Ground	
96	XSDRCS0	O	SDRAM chip select	199	XCRD	I	CPU read signal	
97	XSDRCS1	O			200	XCWR	I	CPU write signal
98	SDRDQM	O	SDRAM data enable	201	XCIHQ	O	CPU interrupt request	
99	LVDD		Power supply +3.3V	202	XFTMIRQ1	O	Power supply +3.3V	
100	SDRCLK	O	SDRAM clock	203	LVDD			
101	XTCLR	I	Test counter clear	204	XFTMIRQ2	O	CPU interrupt request	
102	HVDD		Power supply +5V	205	XFTMIRQ3	O		
103	TESTRAM	I	RAM test mode	206	FSPLAY	O	FS count signal	
104	VSS		Ground	207	SCANEN	I	Scan enable input	
				208	VSS		Ground	

● S1L50553F21Y000 (X4195A0R) MCI (Gate Array)

DM: IC503

PIN NO.	NAME	I/O	FUNCTION	PIN NO.	NAME	I/O	FUNCTION
1	CLKI	I	} Clock	41	VDD	-	Power supply
2	CLKO	O		42	RESET	I	Reset
3	VDD	-	Power supply	43	VSS	-	Ground
4	SCANENB	I/O	Scan enable	44	OUT4	O	} Output
5	ATPGENB	I/O		45	OUT3	O	
6	VSS	-	Ground	46	INP2	I	} Input
7	PLLTEST	I	Test	47	INP1	I	
8	PLLRES	I	Reset	48	INP0	I	
9	PLLVSS	-	Ground	49	TESTENB	I/O	Test enable
10	MVDD	-	Power supply	50	VSS	-	Ground
11	PLLVSS	-	Ground	51	OSCO		
12	AVDD	-	Analog power supply	52	VDD	-	Power supply
13	CHG0			53	OSCI		
14	LPVSS	-	} Ground	54	VSS	-	Ground
15	VSS	-		55	SIRQ	I/O	Interrupt request
16	MIRQ	I/O	Interrupt request	56	SCS	I	Control port
17	MCS	I	Control port	57	SWR	I	Write
18	MWR	I	Write	58	SRD	I	Read
19	MRD	I	Read	59	SA		
20	MA			60	VSS	-	Ground
21	VDD	-	Power supply	61	VDD	-	Power supply
22	MD0	I/O	} DRAM data bus	62	SD0	I/O	} Serial data
23	MD1	I/O		63	SD1	I/O	
24	MD2	I/O		64	SD2	I/O	
25	MD3	I/O		65	SD3	I/O	
26	MD4	I/O		66	SD4	I/O	
27	MD5	I/O		67	SD5	I/O	
28	MD6	I/O		68	SD6	I/O	
29	MD7	I/O		69	SD7	I/O	
30	VSS	-	Ground	70	VSS	-	Ground
31	MD8	I/O	DRAM data bus	71	SD8	I/O	Serial data
32	VDD	-	Power supply	72	VDD	-	Power supply
33	MD9	I/O	} DRAM data bus	73	SD9	I/O	} Serial data
34	MD10	I/O		74	SD10	I/O	
35	MD11	I/O		75	SD11	I/O	
36	MD12	I/O		76	SD12	I/O	
37	MD13	I/O		77	SD13	I/O	
38	MD14	I/O		78	SD14	I/O	
39	MD15	I/O		79	SD15	I/O	
40	VSS	-	Ground	80	VSS	-	Ground

● MB3516APF-G-BND-EF (X2314A00) RGB ENCODER

DM: IC406

PIN NO.	NAME	I/O	FUNCTION	PIN NO.	NAME	I/O	FUNCTION
1	GND1	-	Ground	13	N.C.	-	Not used
2	R-IN	I	Analog R signal input	14	N.C.	-	Not used
3	G-IN	I	Analog G signal input	15	CROMA-OUT	O	Chrominance signal output
4	B-IN	I	Analog B signal input	16	Y-OUT	O	Y-signal output
5	N.C.	-	Not used	17	Y-TRAP	-	Luminance signal band control
6	fsc-IN	I	Subcarrier input	18	N.C.	-	Not used
7	NTSC/PAL-IN	I	NTSC/PAL selector	19	Vcc2	-	Power supply +5 V
8	N.C.	-	Not used	20	VIDEO-OUT	O	Composite video signal output
9	N.C.	-	Not used	21	B-OUT	O	Analog B signal output
10	CSYNC-IN	I	Composite sync signal input	22	G-OUT	O	Analog G signal output
11	N.C.	-	Not used	23	R-OUT	O	Analog R signal output
12	Vcc1	-	Power supply +5 V	24	GND2	-	Ground

● **M34519M6-521FP (X5646200) CPLD (Complex Programmable Logic Device)**

PNL: IC2, 3
PNR: IC2, 3

PIN NO.	NAME	I/O	FUNCTION	PIN NO.	NAME	I/O	FUNCTION			
1	P13	I/O	Port P1 serves as a 4-bit I/O port	22	VDD	-	Power supply +5V			
2	D0	I/O	Each pin of port D has an independent 1-bit wide I/O function	23	VDCE	I	This pin is used to operate/stop the voltage drop detection circuit			
3	D1	I/O		Port P3 serves as a 4-bit I/O port / INTO pin and INT1 pin accept external interrupts	24	P30/INT0	I/O	Port P3 serves as a 4-bit I/O port		
4	D2	I/O			Port P6 serves as a 4-bit I/O port / A/D converter analog input pins	25	P31/INT1		I/O	
5	D3	I/O				Port P5 serves as a 4-bit I/O port	26		P32	I/O
6	D4	I/O					Port P2 serves as a 3-bit I/O port / Serial I/O data transfer synchronous clock I/O pin		27	P33
7	D5	I/O	Port P2 serves as a 3-bit I/O port / Serial I/O data output pin						28	P60/AIN0
8	D6/CNTR0	I/O		Port P2 serves as a 3-bit I/O port / Serial I/O data input pin				29	P61/AIN1	I/O
9	D7/CNTR1	I/O			An N-channel open-drain I/O pin for a system reset Connect CNVSS to VSS and apply "L" (0V) to CNVSS certainly			30	P62/AIN2	I/O
10	P50	I/O				I/O pins of the main clock generating circuit		31	P63/AIN3	I/O
11	P51	I/O					Ground	32	P40/AIN4	I/O
12	P52	I/O	Port P0 serves as a 4-bit I/O port					33	P41/AIN5	I/O
13	P53	I/O		Port P0 serves as a 4-bit I/O port				34	P42/AIN6	I/O
14	P20/SCK	I/O			Port P0 serves as a 4-bit I/O port			35	P43/AIN7	I/O
15	P21/SOUT	I/O				Port P0 serves as a 4-bit I/O port		36	P00	I/O
16	P22/SIN	I/O					Port P1 serves as a 4-bit I/O port	37	P01	I/O
17	RESET	I/O	Port P1 serves as a 4-bit I/O port					38	P02	I/O
18	CNVSS	-		Port P1 serves as a 4-bit I/O port				39	P03	I/O
19	XOUT	O			Port P1 serves as a 4-bit I/O port			40	P10	I/O
20	XIN	I				Port P1 serves as a 4-bit I/O port		41	P11	I/O
21	VSS	-					Port P1 serves as a 4-bit I/O port	42	P12	I/O

● **DM9000AEP (X7029A00) LAN CONTROLLER**

DM: IC210

PIN NO.	NAME	I/O	FUNCTION	PIN NO.	NAME	I/O	FUNCTION			
1	BGRES	I/O	Bandgap pin	25	SD13	I/O	Processor data bus			
2	RXVDD25	-	Power output +2.5 V	26	SD12	I/O				
3	RX+	I/O	TP RX input	27	SD11	I/O				
4	RX-	I/O		RX ground	28	SD10		I/O		
5	RXGND	-	TX ground		29	SD9		I/O		
6	TXGND	-	TP TX output	30	VDD	-	Digital power supply +3.3 V			
7	TX+	I/O		Power output +2.5 V	31	SD8	I/O	Processor data bus		
8	TX-	I/O	Processor data bus		32	CMD	I	Command type		
9	TXVDD25	-		Digital ground	33	GND	-	Digital ground		
10	SD7	I/O			Interrupt request	34	INT	O	Interrupt request	
11	SD6	I/O				Processor read command	35	IOR	I	Processor read command
12	SD5	I/O					Processor write command	36	IOW	I
13	SD4	I/O	Chip select					37	CS	I
14	SD3	I/O		Link/Active LED				38	LED2	O
15	GND	-			Speed LED			39	LED1	O
16	SD2	I/O				Power on reset		40	PWRST	I
17	SD1	I/O					Operation mode	41	TEST	I
18	SD0	I/O	Digital power supply +3.3 V					42	VDD	-
19	EEDIO	I/O		Crystal 25 MHz out				43	X2	O
20	EECK	O			Crystal 25 MHz in			44	X1	I
21	EECS	O				Digital ground		45	GND	-
22	SD15	I/O					Fiber-optic signal detect	46	SD	I
23	VDD	-	RX ground					47	RXGND	-
24	SD14	I/O		Bandgap ground				48	BGGND	-

● **AK5381VT-E2 (X5219A0R) ADC (Analog to Digital Converter)**

DM: IC902

PIN NO.	NAME	I/O	FUNCTION	PIN NO.	NAME	I/O	FUNCTION
1	AINR	I	Rch Analog input pin	9	SDTO	O	Audio serial data output pin
2	AINL	I	Lch Analog input pin	10	LRCK	I/O	Output channel clock pin
3	CKS1	I	Mode select 1 pin	11	MCLK	I	Master clock input pin
4	VCOM	O	Common voltage output pin	12	SCLK	I/O	Audio serial data clock pin
5	AGND	-	Analog ground	13	PDN	I	Power down mode pin
6	VA	-	Analog power supply	14	DIF	I	Audio interface format pin
7	VD	-	Digital power supply	15	CKS2	I	Mode select 2 pin
8	DGND	-	Digital ground	16	CKS0	I	Mode select 0 pin

● **AK4396VF-E2 (X8324A00) DAC (Digital to Analog Converter)**

DM: IC900, 901

PIN NO.	NAME	I/O	FUNCTION	PIN NO.	NAME	I/O	FUNCTION
1	DV	-	Digital ground	15	TTL	I	CMOS/TTL level select
2	DVDD	-	Digital power supply +3.3 V	16	VREFL	I	Low level voltage reference input
3	MCLK	I	Master clock input	17	VREFH	I	High level voltage reference input
4	PDN	I	Power-down mode	18	AVDD	-	Analog power supply +5 V
5	BICK	I	Audio serial data clock	19	AVSS	-	Analog ground
6	SDATA	I	Audio serial data input	20	AOUTR-	O	Rch negative analog output
7	LRCK	I	L/R clock	21	AOUTR+	O	Rch positive analog output
8	SMUTE/CSN	I	Soft mute/Chip select	22	AOU TL-	O	Lch negative analog output
9	DFS0/CAD0	I	Sampling speed mode select/Chip address 0	23	AOU TL+	O	Lch positive analog output
10	DEM0/CCLK	I	De-emphasis enable 0/Control data clock	24	VCOM	O	Common voltage output
11	DEM1/CDTI	I	De-emphasis enable 1/Control data input	25	P/S	I	Parallel/serial select
12	DIF0	I	Digital input format	26	TST1/DZFL	O	Test 1/Lch zero input detect
13	DIF1	I		27	TST2/CAD1	I	Test 2/Chip address 1
14	DIF2	I		28	ACKS/DZFR	I/O	Master clock auto setting mode/Rch zero input detect

● **DS99R103TSQX/NOPB (X9323A00) LVDS**

DM: IC8

PIN NO.	NAME	I/O	FUNCTION	PIN NO.	NAME	I/O	FUNCTION	
1	DIN[23:0]	I	Transmitter Parallel Interface Data Inputs Pins. Tie LOW if unused.	19	DOU T-	O	Transmitter LVDS Inverted (-) Output. This output is intended to be loaded with a 100 ohm load to the DOU T- pin.	
2	DIN[23:0]	I		20	DOU T+	O		Transmitter LVDS True (+) Output. This output is intended to be loaded with a 100 ohm load to the DOU T+ pin.
3	DIN[23:0]	I		RESERVED - This pin MUST be tied LOW.	21	VSSDR	O	Analog Ground, LVDS Output Ground
4	DIN[23:0]	I			22	VDDDR	O	
5	DCAOFF	I	Digital Ground, Tx Logic Ground	23	PRE	I	PRE-emphasis select pin. • PRE = (RPRE ≥ 3 kΩ); I _{max} = [(1.2/R) 20], R _{min} = 3 kΩ • PRE = H or floating; pre-emphasis is disabled	
6	VSSL	I	Digital Voltage supply, Tx Logic Power	24	VSS	I	ESD Ground	
7	VDDL	I	RESERVED - This pin MUST be tied LOW.	25	DIN[23:0]	I		
8	DCBOFF	I	Transmitter Power Down Bar	26	DIN[23:0]	I	Transmitter Parallel Interface Data Inputs Pins. Tie LOW if unused.	
9	TPWDNB	I	• TPWDNB = H; Transmitter is Enabled and ON. • TPWDNB = L; Transmitter is in power down mode (Sleep), LVDS Driver DOU T (+/-) Outputs are in TRI-STATE stand-by mode, PLL is shutdown to minimize power consumption.	27	DIN[23:0]	I		
10	TCLK	I	Transmitter Parallel Interface Clock Input Pin. Strobe edge set by TRFB configuration pin	28	DIN[23:0]	I		
				29	DIN[23:0]	I		
11	TRFB	I	Transmitter Clock Edge Select Pin • TRFB = H; Parallel Interface Data is strobed on the Rising Clock Edge • TRFB = L; Parallel Interface Data is strobed on the Falling Clock Edge	30	VDDT	I	Digital Voltage supply, Tx Serializer Power Digital Ground, Tx Serializer Ground	
				31	VSS T	I		
12	VODSEL	I	VOD Level Select • VODSEL = L; LVDS Driver Output is ~400 mV (RL = 100 Ω) • VODSEL = H; LVDS Driver Output is ~800 mV (RL = 100 Ω) For normal applications, set this pin LOW. For long cable applications where a larger VOD is required, set this pin HIGH.	32	DIN[23:0]	I	Transmitter Parallel Interface Data Inputs Pins. Tie LOW if unused.	
				33	DIN[23:0]	I		
13	RESRVD	I	RESERVED - This pin MUST be tied LOW.	34	DIN[23:0]	I		
				35	DIN[23:0]	I		
14	VDDPT1	I	Analog Voltage supply, PLL Power	36	DIN[23:0]	I		
				37	DIN[23:0]	I		
15	VSSPT1	I	Analog Ground, PLL Ground	38	DIN[23:0]	I		
				39	DIN[23:0]	I		
16	VDDPT0	I	Analog Voltage supply, VCO Power	40	DIN[23:0]	I	Digital Voltage supply, Tx Input Power Digital Ground, Tx Input Ground	
				41	DIN[23:0]	I		
17	VSSPT0	I	Analog Ground, VCO Ground	42	VDDIT	I		
				43	VSSIT	I		
18	DEN	I	Transmitter Data Enable • DEN = H; LVDS Driver Outputs are Enabled (ON). • DEN = L; LVDS Driver Outputs are Disabled (OFF), Transmitter LVDS Driver DOU T (+/-) Outputs are in TRI-STATE, PLL still operational and locked to TCLK.	44	DIN[23:0]	I	Transmitter Parallel Interface Data Inputs Pins. Tie LOW if unused.	
				45	DIN[23:0]	I		
46	DIN[23:0]	I						
47	DIN[23:0]	I						
				48	DIN[23:0]	I		

● DS99R104TSQX/NOPB (X9324A00) LVDS

LCL: IC2

PIN NO.	NAME	I/O	FUNCTION	PIN NO.	NAME	I/O	FUNCTION
1	RPWDNB	I	Receiver Data Enable • REN = H; ROUT[23-0] and RCLK are Enabled (ON). • REN = L; ROUT[23-0] and RCLK are Disabled (OFF), Receiver ROUT[23-0] and RCLK Outputs are in TRI-STATE, PLL still operational and locked to TCLK.	26	ROUT[7:0]	O	Receiver Parallel Interface Data Outputs - Group 1
				27	ROUT[7:0]	O	
				28	ROUT[7:0]	O	
2	RESRVD	I	RESERVED - This pin MUST be tied LOW. LVDS SERIAL INTERFACE PINS	29	VssOR1	O	Digital Ground, LVCMOS Output Ground Digital Voltage supply, LVCMOS Output Power
				30	VDDOR1	O	
3	ROUT[23:16]	O	Receiver Parallel Interface Data Outputs _ Group 3	31	ROUT[7:0]	O	Receiver Parallel Interface Data Outputs - Group 1
4	ROUT[23:16]	O					
5	ROUT[23:16]	O					
6	ROUT[23:16]	O	Receiver Parallel Interface Data Outputs _ Group 3	32	ROUT[7:0]	O	Receiver Parallel Interface Data Outputs - Group 1
7	VDDOR3	O					
8	VssOR3	O					
9	ROUT[23:16]	O	Receiver Parallel Interface Data Outputs _ Group 3	33	ROUT[7:0]	O	Receiver Parallel Interface Data Outputs - Group 1
10	ROUT[23:16]	O					
11	ROUT[23:16]	O					
12	ROUT[23:16]	O	Receiver Parallel Interface Data Outputs - Group 2	34	ROUT[7:0]	O	Receiver Parallel Interface Data Outputs - Group 1
13	ROUT[15:8]	O					
14	ROUT[15:8]	O					
15	ROUT[15:8]	O	Receiver Parallel Interface Data Outputs - Group 2	35	VssR0	O	Digital Ground, Logic Ground Digital Voltage supply, Logic Power
16	ROUT[15:8]	O					
17	LOCK	O					
18	RCLK	O	LOCK indicates the status of the receiver PLL • LOCK = H; receiver PLL is locked • LOCK = L; receiver PLL is unlocked, ROUT[23-0] and RCLK are TRI-STATE Parallel Interface Clock Output Pin. Strobe edge set by RRFB configuration pin.	36	VDDR0	O	Digital Voltage supply, Logic Power Digital Voltage supply, Logic Power
				37	VDDR1	O	
				38	VssR1	O	
19	VssOR2	O	Digital Ground, LVCMOS Output Ground	39	VDDIR	O	Analog LVDS Voltage supply, Power Analog LVDS Ground
20	VDDOR2	O	Digital Voltage supply, LVCMOS Output Power	40	VssIR	O	
21	ROUT[15:8]	O	Receiver Parallel Interface Data Outputs - Group 2	41	RIN+	I	
22	ROUT[15:8]	O					
23	ROUT[15:8]	O					
24	ROUT[15:8]	O	Receiver Parallel Interface Data Outputs - Group 2	42	RIN-	I	Receiver LVDS Inverted (-) Input This input is intended to be terminated with a 100 ohm load to the RIN- pin.
25	ROUT[7:0]	O					
			LOCK indicates the status of the receiver PLL • LOCK = H; receiver PLL is locked • LOCK = L; receiver PLL is unlocked, ROUT[23-0] and RCLK are TRI-STATE Parallel Interface Clock Output Pin. Strobe edge set by RRFB configuration pin.	43	RRFB	I	Receiver Clock Edge Select Pin • RRFB = H; ROUT LVCMOS Outputs strobed on the Rising Clock Edge. • RRFB = L; ROUT LVCMOS Outputs strobed on the Falling Clock Edge.
			Parallel Interface Clock Output Pin. Strobe edge set by RRFB configuration pin.	44	VssPR1	O	Analog Ground, PLL VCO Ground Analog Voltage supply, PLL VCO Power
			Digital Ground, LVCMOS Output Ground	45	VDDPR1	O	
			Digital Voltage supply, LVCMOS Output Power	46	VssPR0	O	
			Digital Voltage supply, LVCMOS Output Power	47	VDDPR0	O	Analog Ground, PLL Ground Analog Voltage supply, PLL Power
			Digital Voltage supply, LVCMOS Output Power	48	REN	I	
			Digital Voltage supply, LVCMOS Output Power				
			Digital Voltage supply, LVCMOS Output Power				Receiver Data Enable • REN = H; ROUT[23-0] and RCLK are Enabled (ON). • REN = L; ROUT[23-0] and RCLK are Disabled (OFF), Receiver ROUT[23-0] and RCLK Outputs are in TRI-STATE, PLL still operational and locked to TCLK.

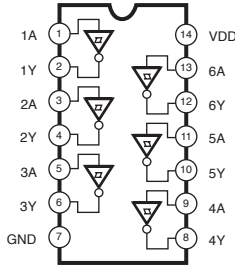
● μPD780031AYGK-N09 (XZ916300) E-PNS2a LED/SWITCH DRIVER

PNL: IC1
PNR: IC1

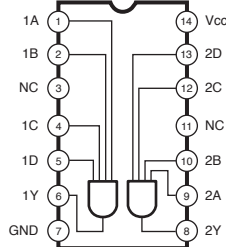
PIN NO.	NAME	I/O	FUNCTION	PIN NO.	NAME	I/O	FUNCTION
1	P50/A8	I/O	Port 5 / Higher address bus	33	P10/ANIO	I	Port 1 / A/D converter analog input
2	P51/A9	I/O					
3	P51/A10	I/O					
4	P53/A11	I/O					
5	P54/A12	I/O					
6	P55/A13	I/O					
7	P56/A14	I/O					
8	P57/A15	I/O					
9	Vss0	-	Ground	34	AVREF	I	A/D converter reference voltage input
10	VDD0	-	Power supply +5 V	35	AVDD	-	Analog power supply +5 V
11	P30	I/O	Port 3	36	RESET	I	System reset input
12	P31	I/O					
13	P32/SDA0	I/O	Port 3 / Serial data input/output	37	XT2	-	Subsystem clock oscillation
14	P33/SCL0	I/O					
15	P34	I/O	Port 3	38	XT1	-	
16	P35	I/O					
17	P36	I/O					
18	P20/SI30	I/O		Port 2 / Serial data input	39	IC	-
19	P21/SO30	I/O	Port 2 / Serial data output	40	X2	-	Main system clock oscillation
20	P22/SCK30	I/O	Port 2 / Serial clock input/output	41	X1	I	
21	P23/RxD0	I/O	Port 2 / Serial data input	42	Vss1	-	Ground
22	P24/TxD0	I/O	Port 2 / Serial data output	43	P00/INTP0	I/O	Port 0 / External interrupt request input
23	P25/ASCK0	I/O	Port 2 / Serial clock input/output	44	P01/INTP1	I/O	
24	VDD1	-	Power supply +5 V	45	P02/INTP2	I/O	
25	AVss	-	Ground	46	P03/INTP3/ADTRG	I/O	Port 0 / External interrupt request input / Trigger signal input
26	P17/ANI7	I	Port 1 / A/D converter analog input	47	P70/TI00/TO0	I/O	Port 7 / External count clock input / 16-bit timer/event counter 0 output
27	P16/ANI6	I					
28	P15/ANI5	I					
29	P14/ANI4	I					
30	P13/ANI3	I					
31	P12/ANI2	I					
32	P11/ANI1	I					
			Port 7 / Capture trigger input	48	P71/TI01	I/O	
			Port 7 / External count clock input / 8-bit timer/event counter 50 output	49	P72/TI50/TO50	I/O	
			Port 7 / External count clock input / 8-bit timer/event counter 51 output	50	P73/TI51/TO51	I/O	
			Port 7 / Clock output	51	P74/PCL	I/O	
			Port 7 / Buzzer output	52	P75/BUZ	I/O	
			Port 6 / Strobe signal output for reading	53	P64/RD	I/O	
			Port 6 / Strobe signal output for writing	54	P65 WR	I/O	
			Port 6 / Wait insertion	55	P66/WAIT	I/O	
			Port 6 / Strobe output	56	P67/ASTB	I/O	
				57	P40/AD0	I/O	Port 4 / Lower address/data bus
				58	P41/AD1	I/O	
				59	P42/AD2	I/O	
				60	P43/AD3	I/O	
				61	P44/AD4	I/O	
				62	P45/AD5	I/O	
				63	P46/AD6	I/O	
				64	A47/AD7	I/O	

IC BLOCK DIAGRAM

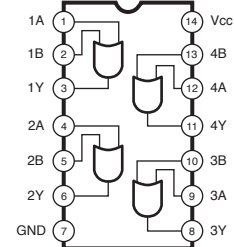
- **SN74AHC14PWR** (X3098A00)
 - **SN74LV14APWR** (X6688A0R)
 - **TC74VHC14FT** (XV890B0R)
- DM: IC4, 5, 7, 510
Hex Inverter



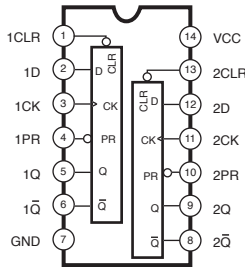
- **SN74LV21APWR** (X2377A0R)
 - **TC74VHC21FT** (X5542A00)
- DM: IC20
Dual 4 Input AND



- **SN74LV32APWR** (X5647A00)
- DM: IC6
- **SN74LVC32APWR** (X5405A00)
- DM: IC212
Quad 2 Input OR

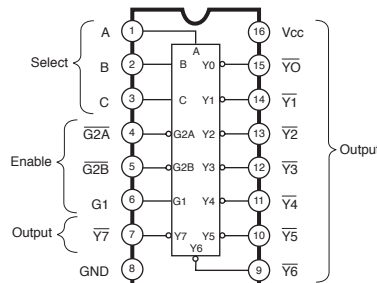


- **SN74ACT74PWR** (X9486A00)
 - **TC74ACT74FT** (X6536A0R)
- DM: IC404
Dual D-Type Flip-Flop

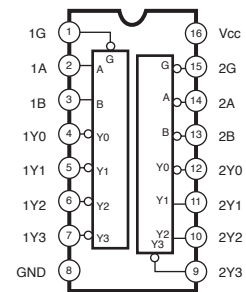


INPUTS				OUTPUTS	
PR	CLR	CLK	D	Q	Q̄
L	H	X	X	H	L
H	L	X	X	L	H
L	L	X	X	H	H
H	H	f	H	H	L
H	H	f	L	L	H
H	H	L	X	Q _o	Q _o

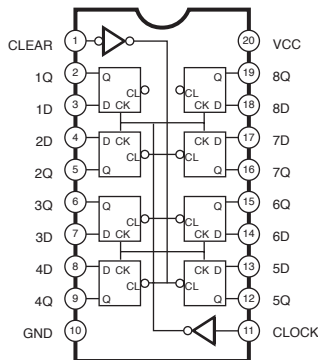
- **SN74LVC138APWR** (X7074A00)
- DM: IC502
3 to 8 Demultiplexer



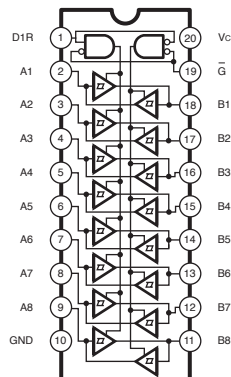
- **HD74LVC139TELL** (X4963A0R)
 - **SN74LVC139APWR** (X7227A00)
- DM: IC24, 25
Dual 2 to 4 Demultiplexer



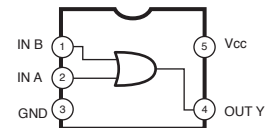
- **SN74LV273APWR** (X5074A00)
 - **TC74VHC273FT** (X7942B00)
- DM: IC23
Octal D-Type Flip-Flop



- **SN74AHCT245PWR** (X2709A0R)
 - **TC74VHCT245AFT** (XT744B0R)
- DM: IC200
- **SN74LV245APWR** (X3693A0R)
 - **TC74VHC245FT** (XU797B00)
 - **SN74LVC245APWR** (XZ287A0R)
- DM: IC16—19, 21, 22, 808—811
Octal 3-State Bus Transceiver

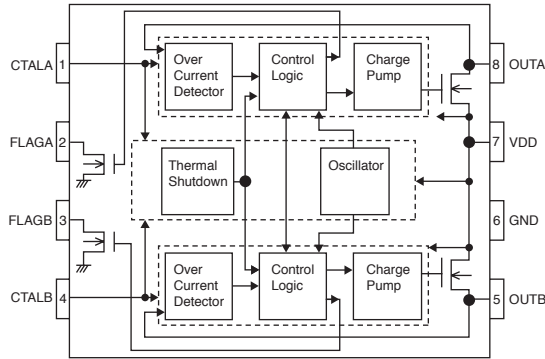
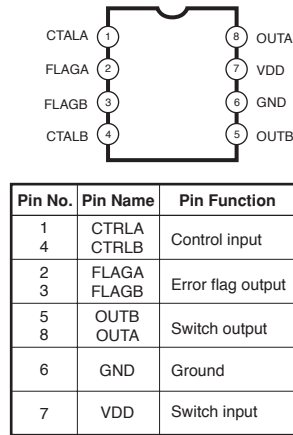


- **SN74LVC1G32DCKR** (X5825A00)
- DM: IC213
2-Input OR Gate

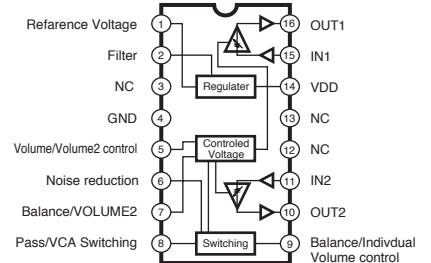


FUNCTION TABLE		
INPUTS		OUTPUT
A	B	Y
H	X	H
X	H	H
L	L	L

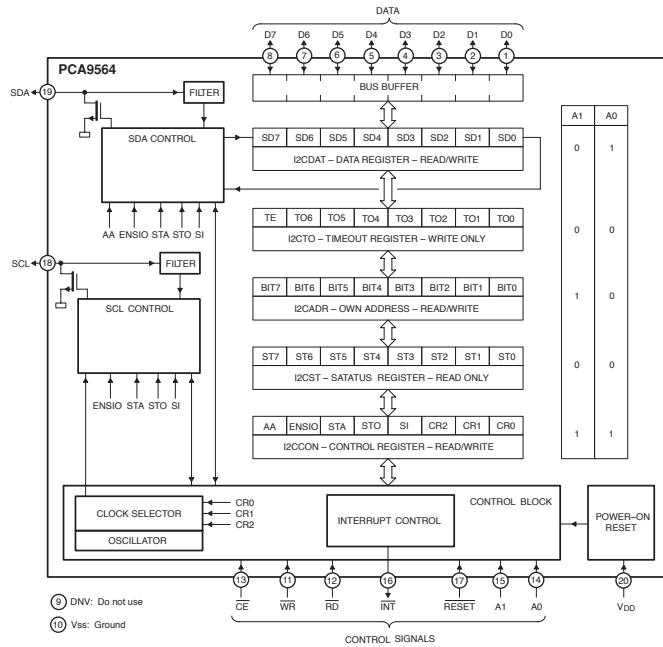
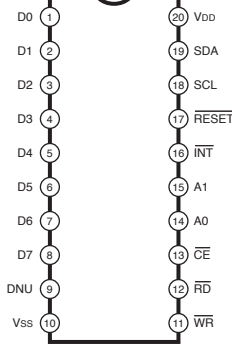
- **BD6517F-E2 (X7951A00)**
DM: IC206
High Side Switch



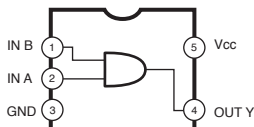
- **M51132L (XE470A0R)**
AJK: IC3
VCA



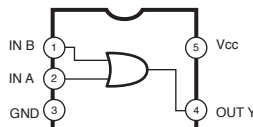
- **PCA9564PW (X6155A0R)**
DM: IC208
Parallel bus to I2C-bus controller



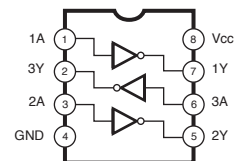
- **TC7SH08FU (XR680A00)**
DM: IC202, 209, 812, 813
2 Input AND Gate



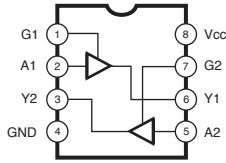
- **TC7SH32FU (XW633A0R)**
DM: IC27, 211
- **TC7SET32FU (XW814A0R)**
DM: IC9
2-Input OR Gate



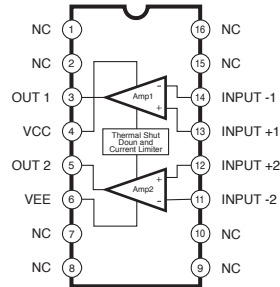
- **TC7WU04FU (XQ805A00)**
DM: IC400, 401
Triple Inverter



- **TC7WT126FU (X7703A00)**
DM: IC405
Dual Bus Buffer

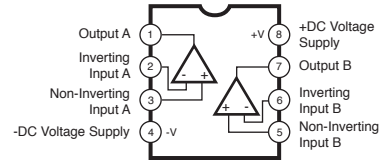


- **LA6517M-TRM-E-R (XT131A0R)**
AJK: IC6
Dual Power Operational Amplifier

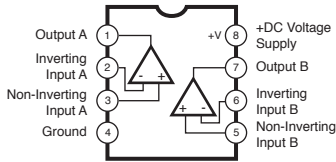


- **NJM2068M-D(TE2) (X3505A00)**
AJK: IC4, 5, 7, 8 DM: IC903, 904, 906
- **NJM2100V (X2538A00)**
EMKS-FD: IC002
- **NJM4580E(TE2) (X2331A0R)**
AJK: IC2

Dual Operational Amplifier



- **NE5532DR (X5482A00)**
DM: IC903, 904, 906
Dual Operational Amplifier

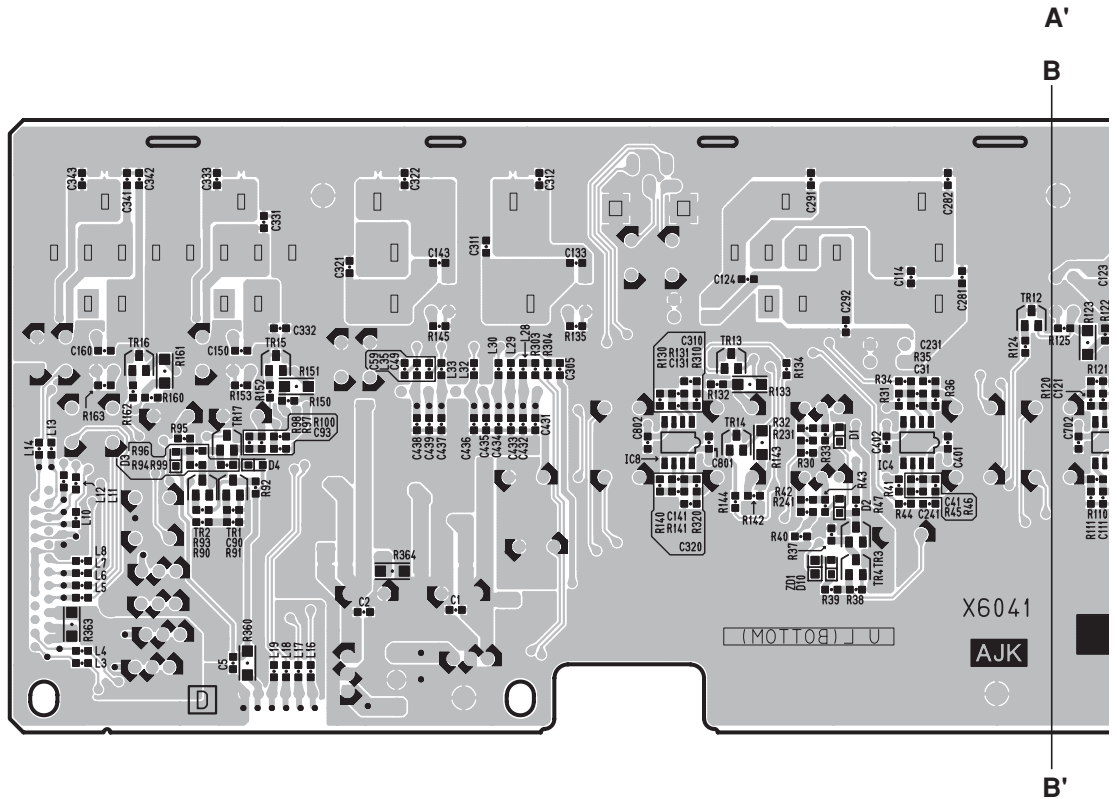
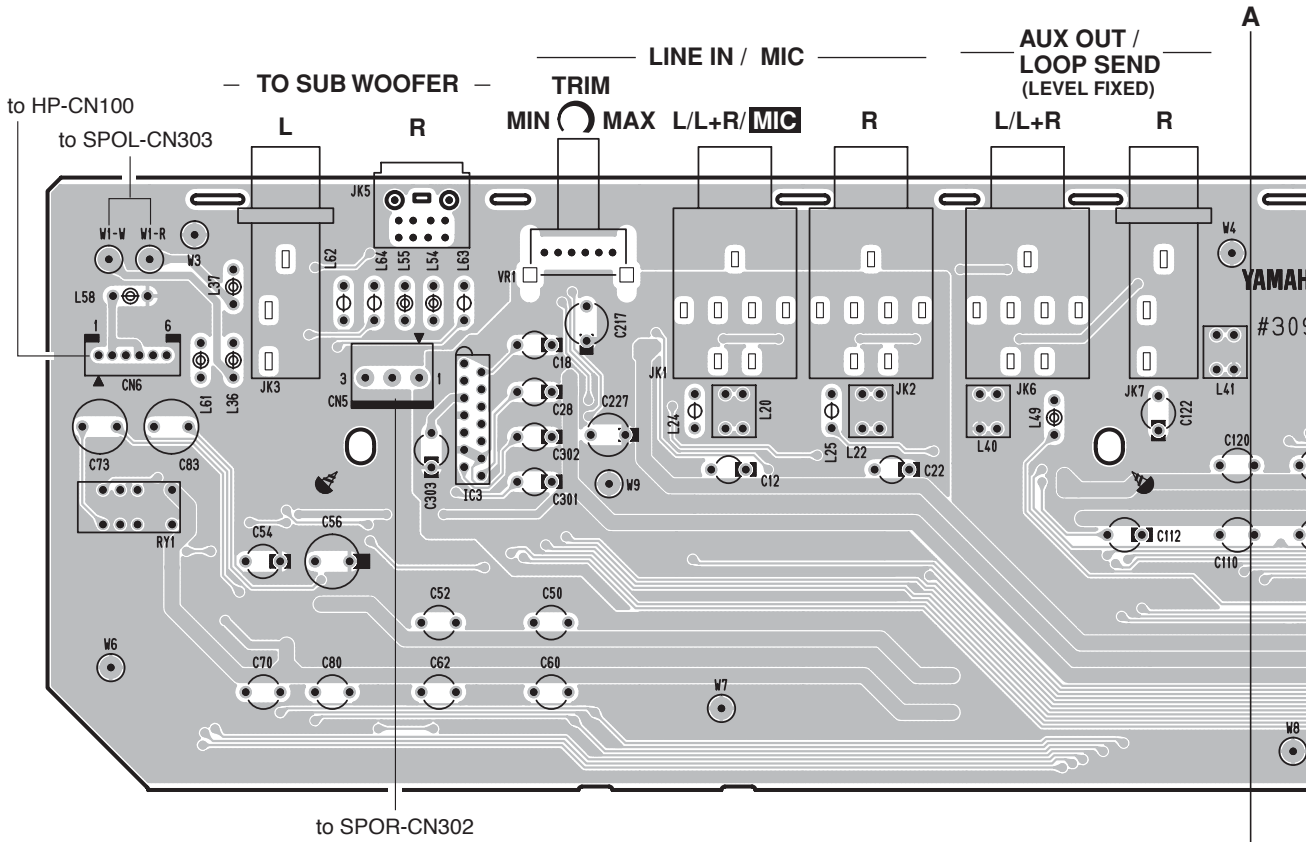


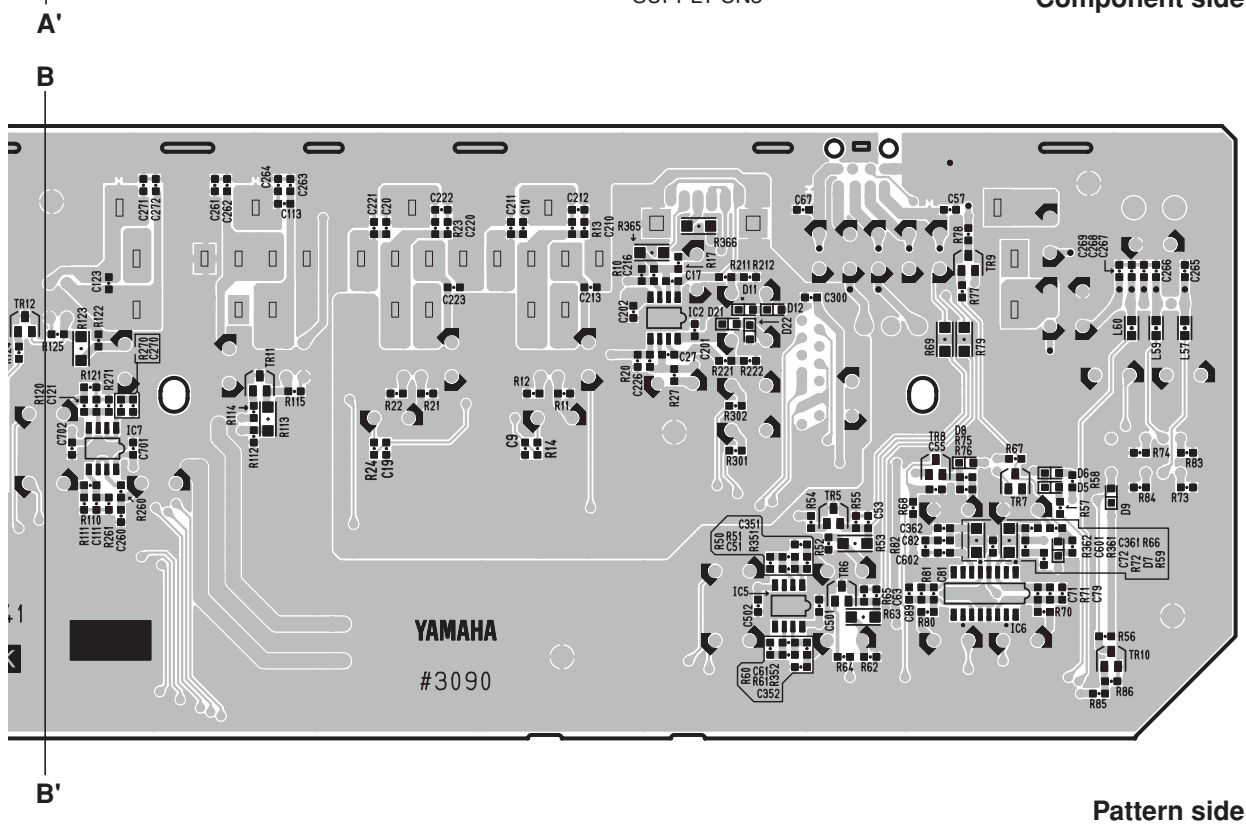
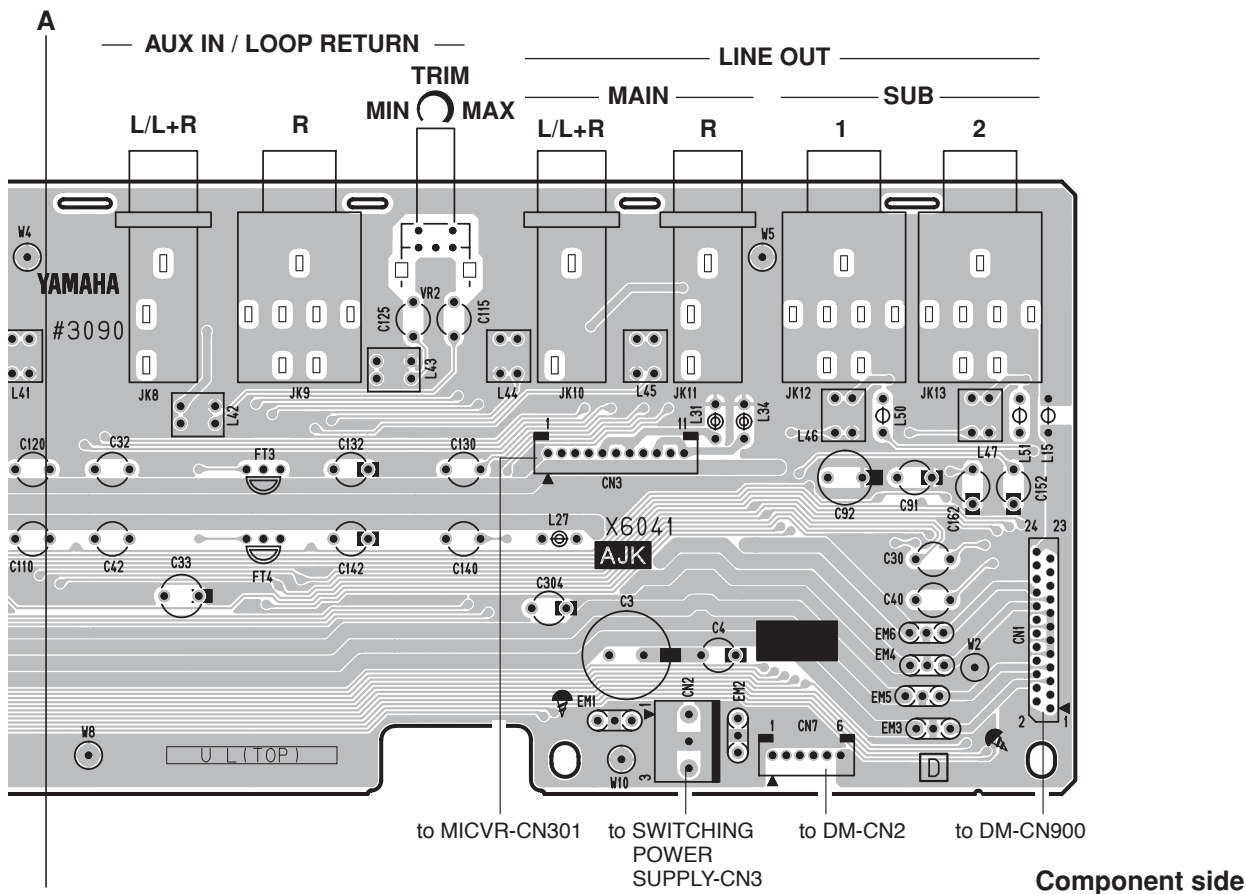
■ CIRCUIT BOARDS

AJK Circuit Board (X6041D0)	48
CK Circuit Board (X6042C0)	58
DJK Circuit Board (X6042C0)	54
DM Circuit Board (X9371C0)	50/52
EMKS-FD Circuit Board (X6577A0)	72/73
EN Circuit Board (X9411B0)	61
HDSB Circuit Board (X6800B0)	57
HP Circuit Board (X6042C0)	56
LCL Circuit Board (X9412C0)	72/73
LCR Circuit Board (X9412C0)	74/75
MICVR Circuit Board (X9409C0)	58
MK61L Circuit Board (X6578C0)	76/77
MKH-D Circuit Board (X6579B0)	72/74
SPOL Circuit Board (X6042C0)	56
SPOR Circuit Board (X6042C0)	56
PNC Circuit Board (X9411B0)	60
PNR Circuit Board (X9410C0)	62/64
PNL Circuit Board (X9409C0)	68/70
PNLS Circuit Board (X9409C0)	59
USB Circuit Board (X9410C0)	59

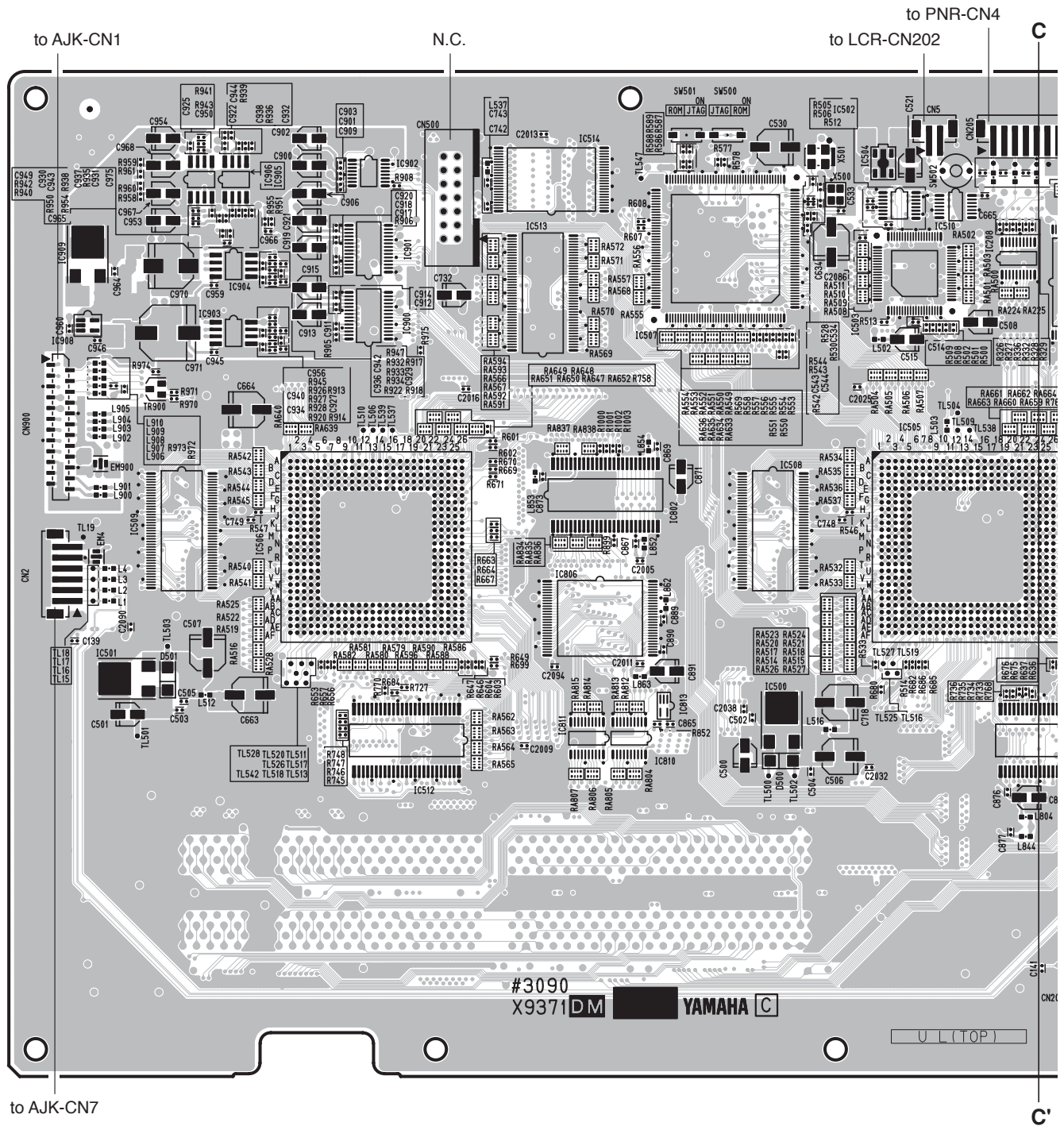
Note: See parts list for details of circuit board component parts.

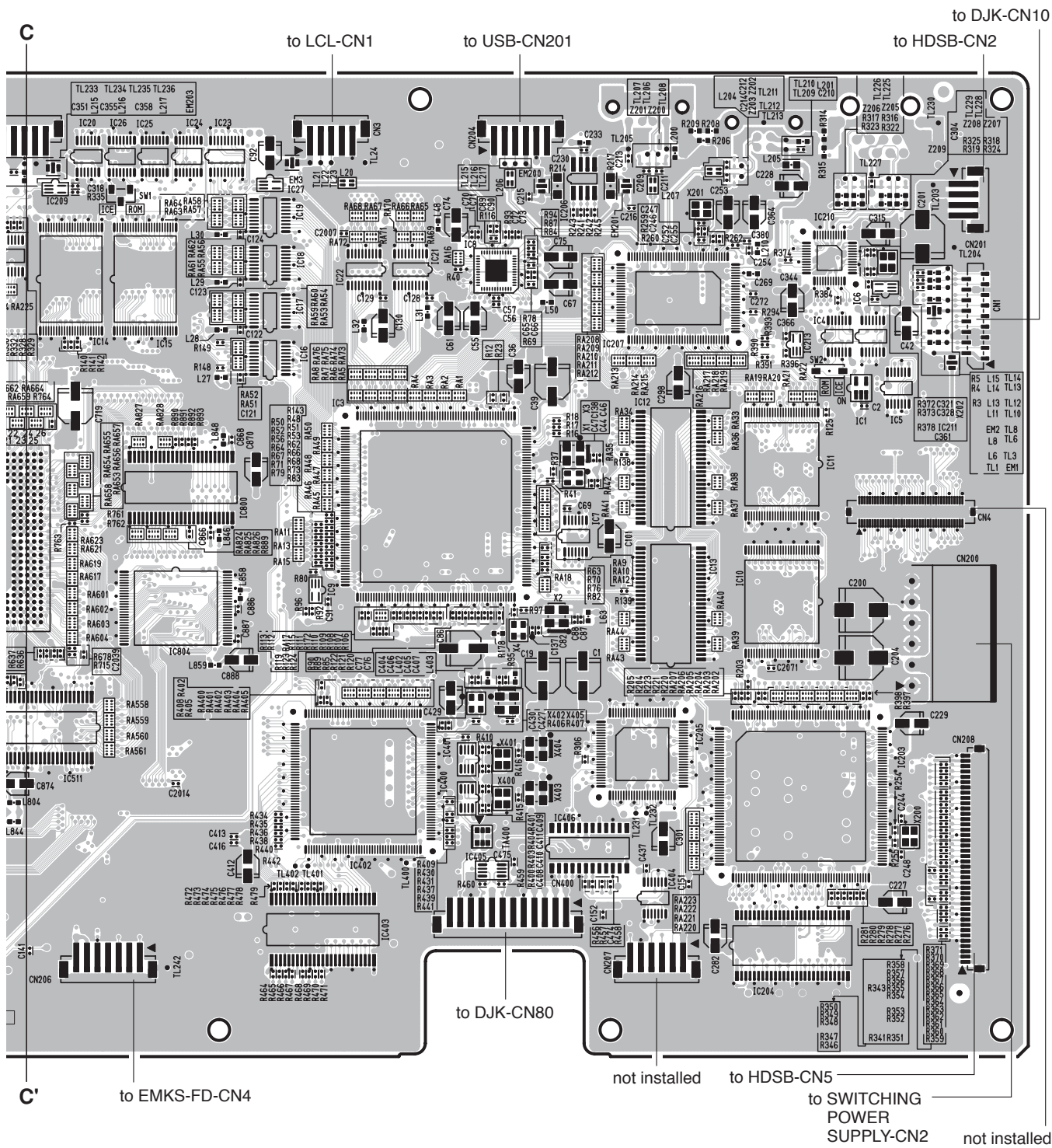
● AJK Circuit Board





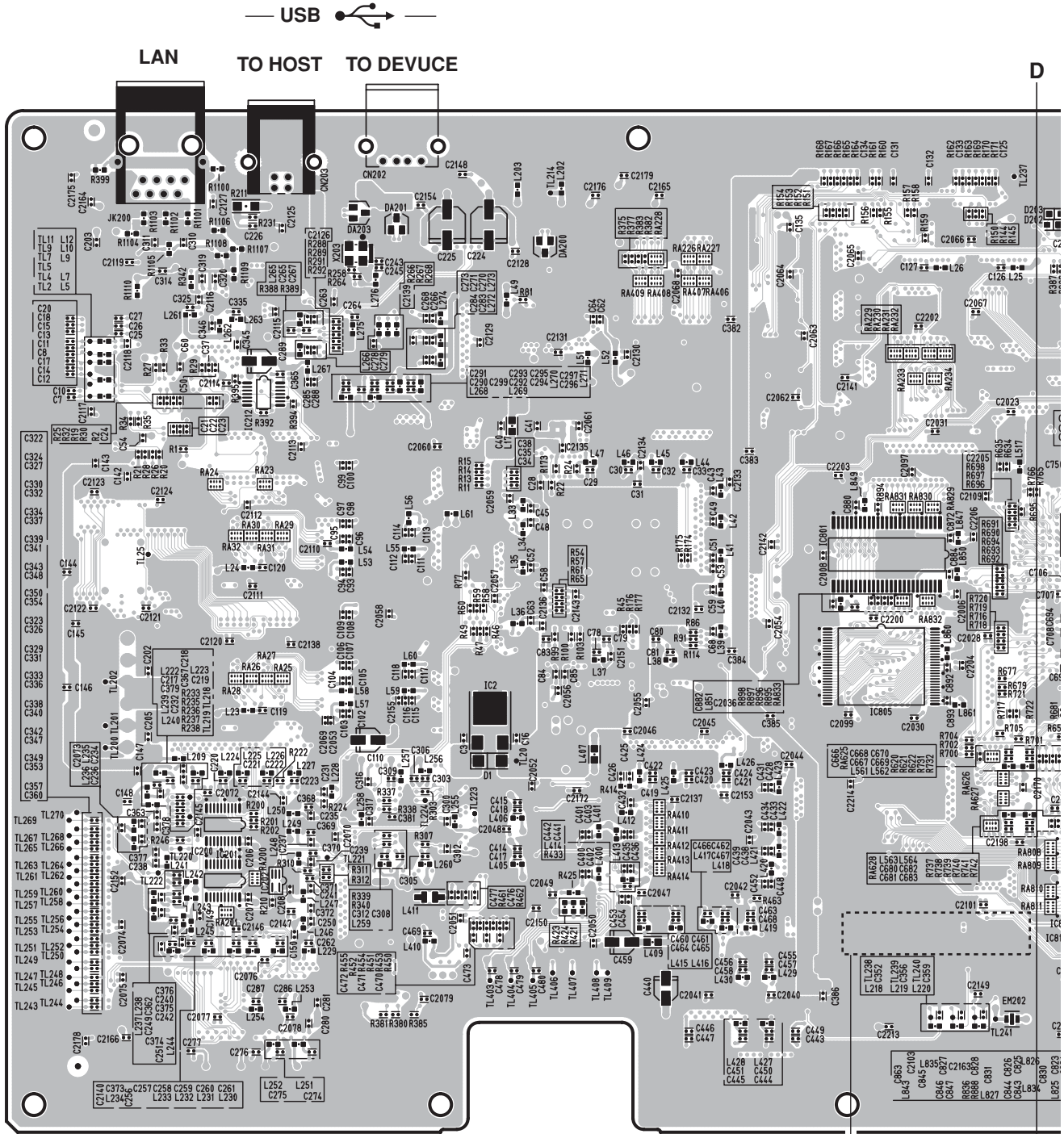
● DM Circuit Board





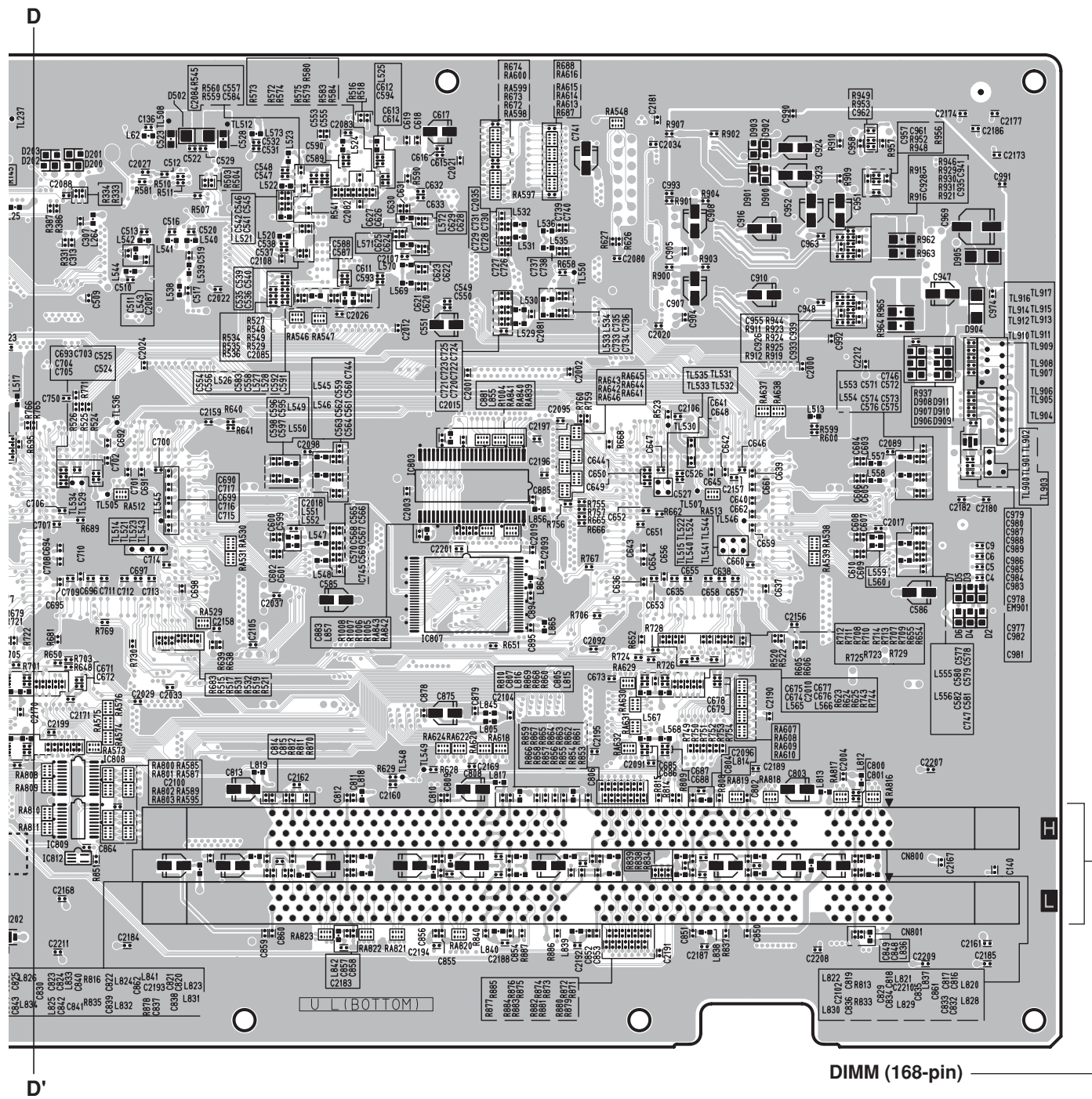
Component side

● DM Circuit Board



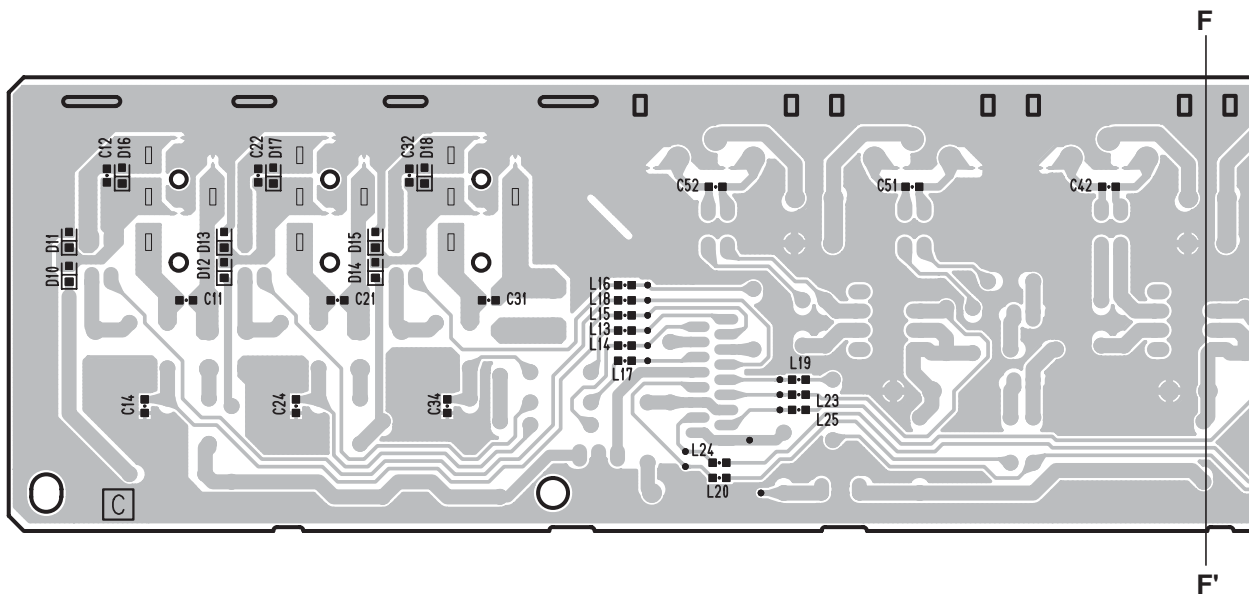
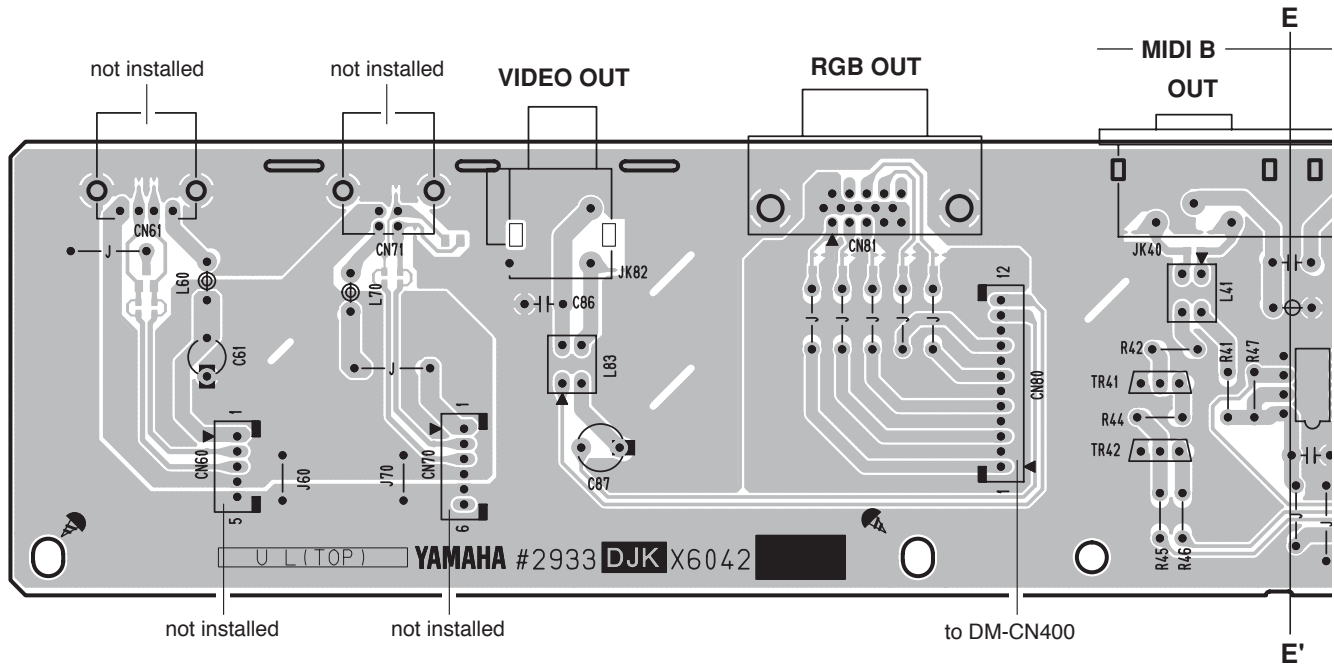
This number is the Ethernet MAC Address written on the DM circuit board. If the DM circuit board is replaced, the MAC address will be changed. The MAC address is required to execute the test program through Ethernet. (Attached in the dotted frame.)

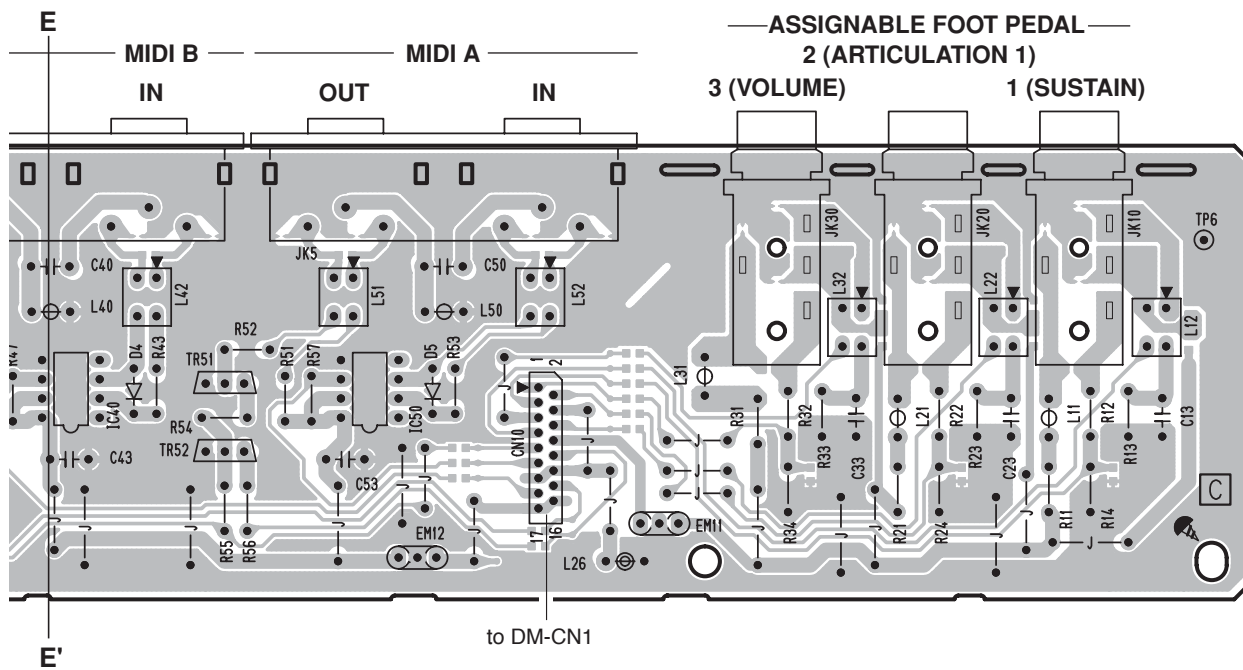




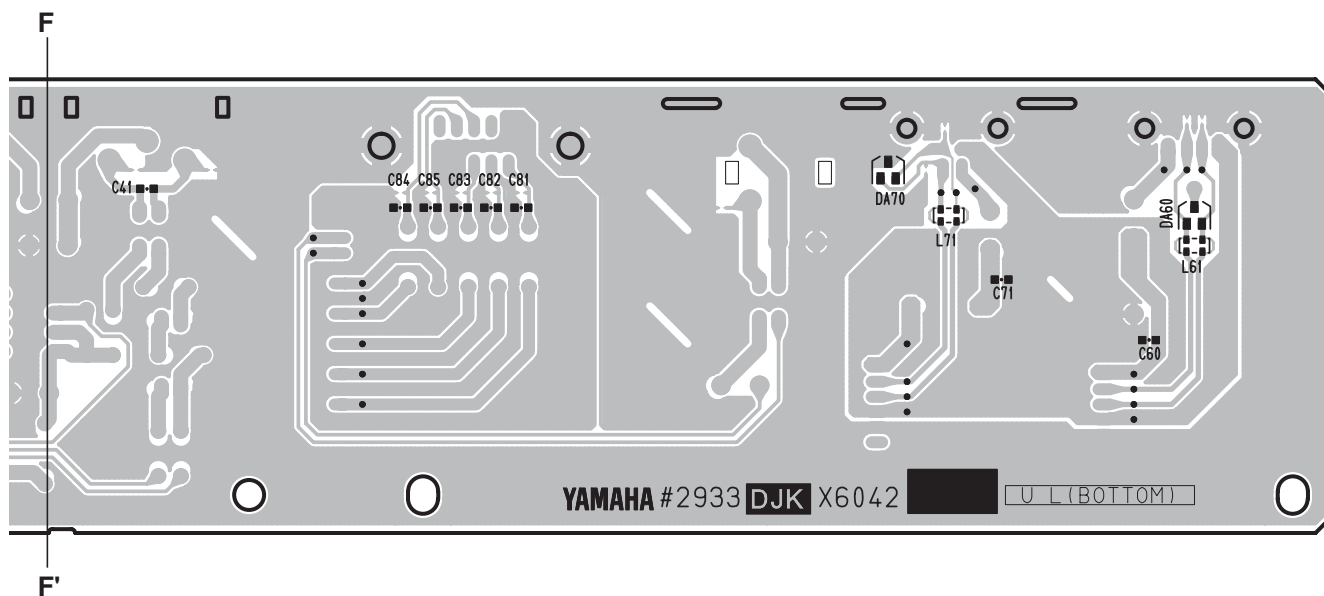
Pattern side

● DJK Circuit Board



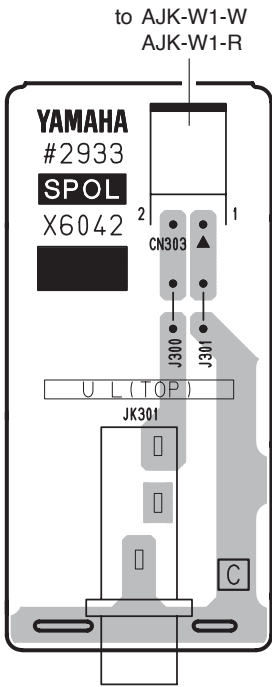


Component side



Pattern side

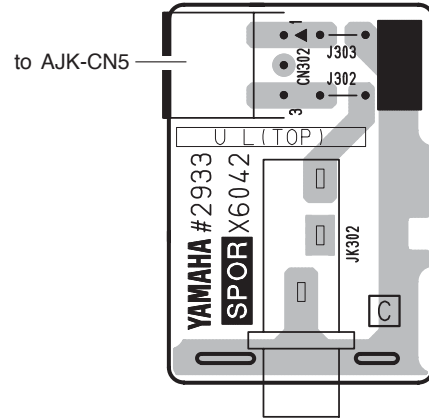
● SPOL Circuit Board



TO LEFT SPEAKER

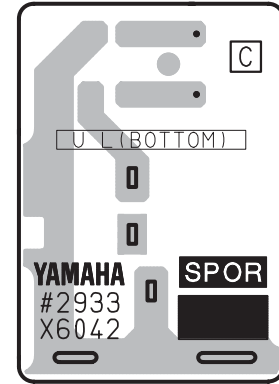
Component side

● SPOR Circuit Board

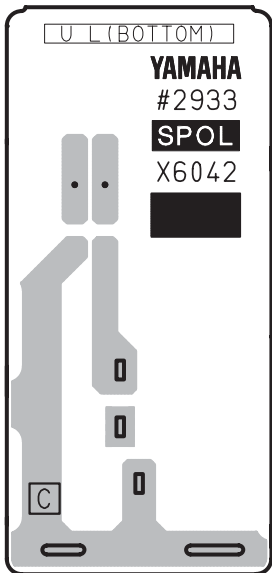


TO RIGHT SPEAKER

Component side

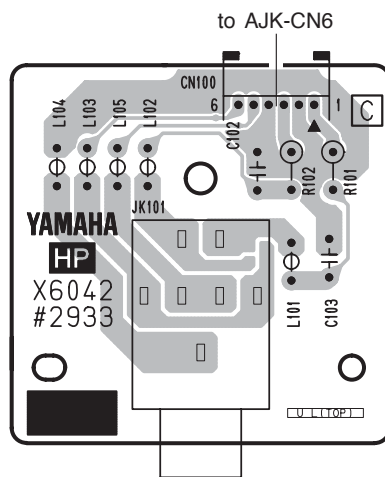


Pattern side



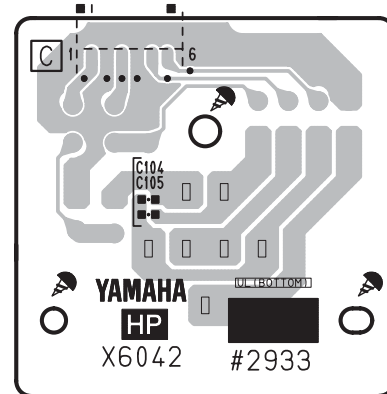
Pattern side

● HP Circuit Board



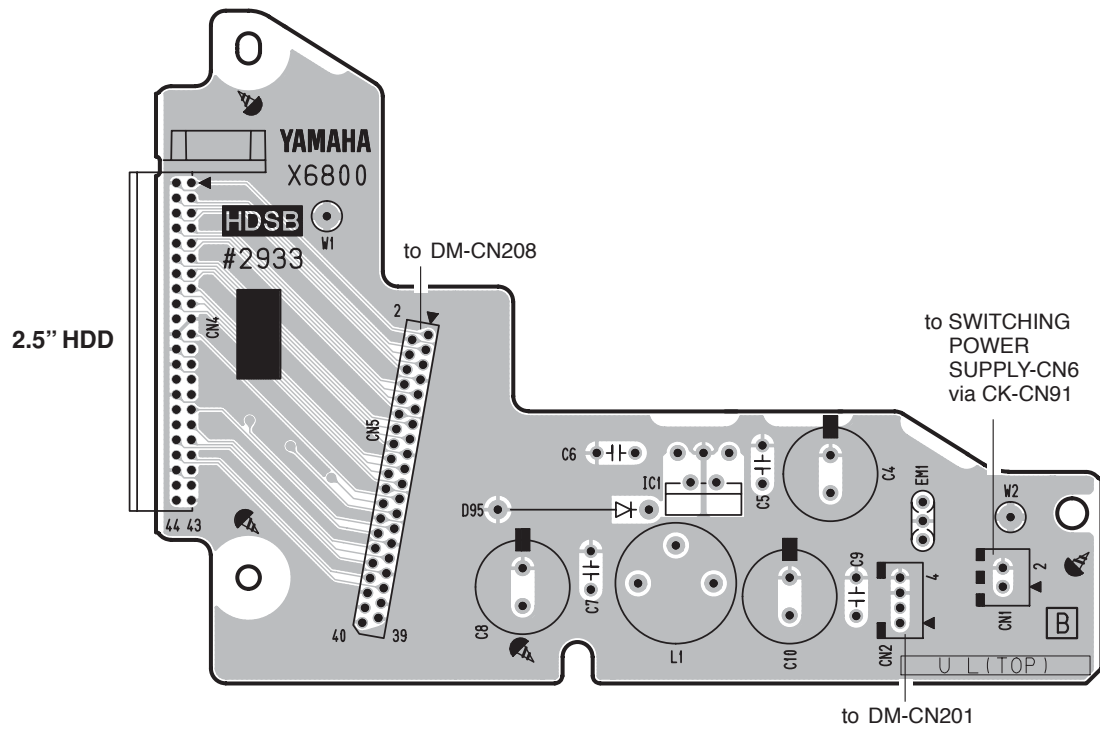
PHONES

Component side

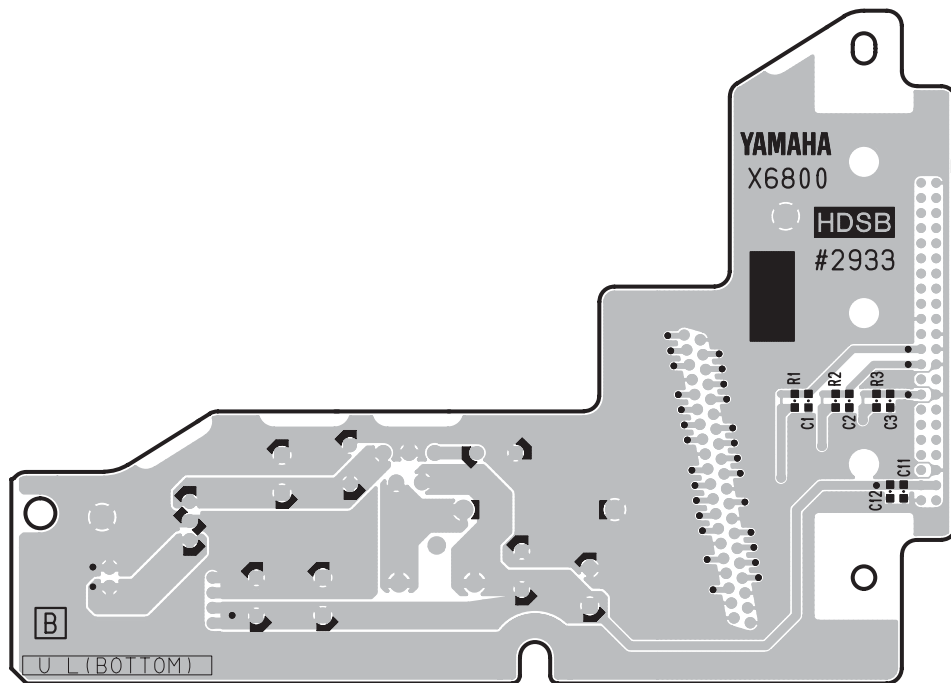


Pattern side

● HDSB Circuit Board

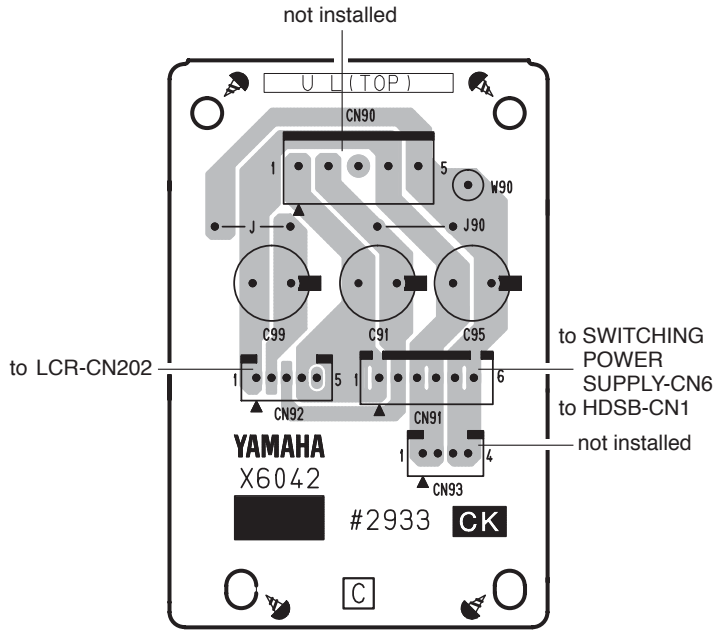


Component side

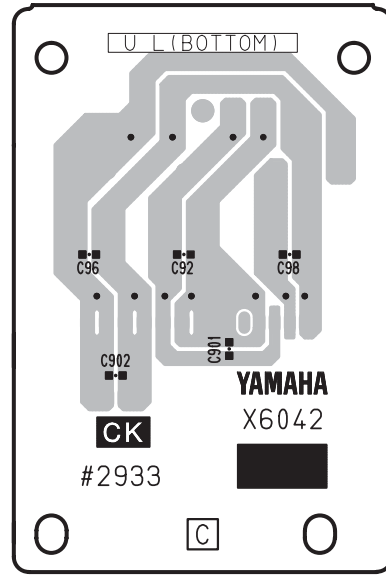


Pattern side

● CK Circuit Board

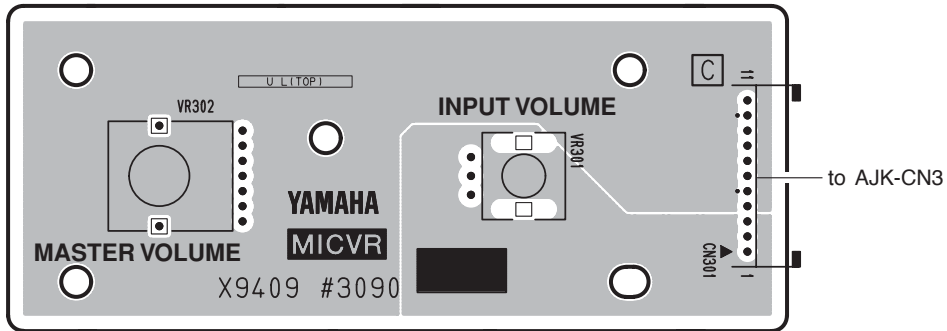


Component side

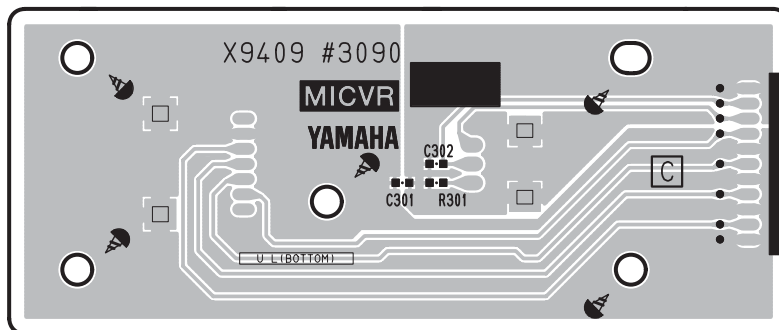


Pattern side

● MICVR Circuit Board

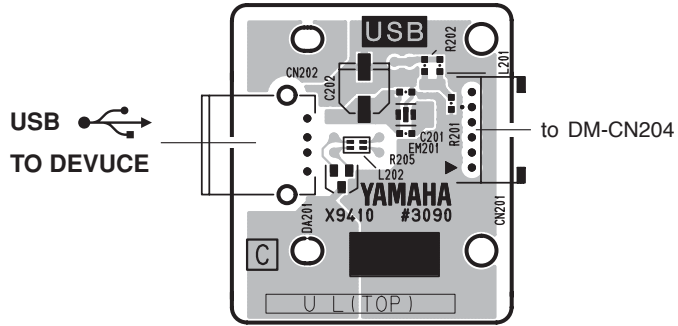


Component side

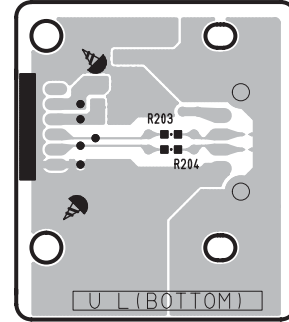


Pattern side

● USB Circuit Board

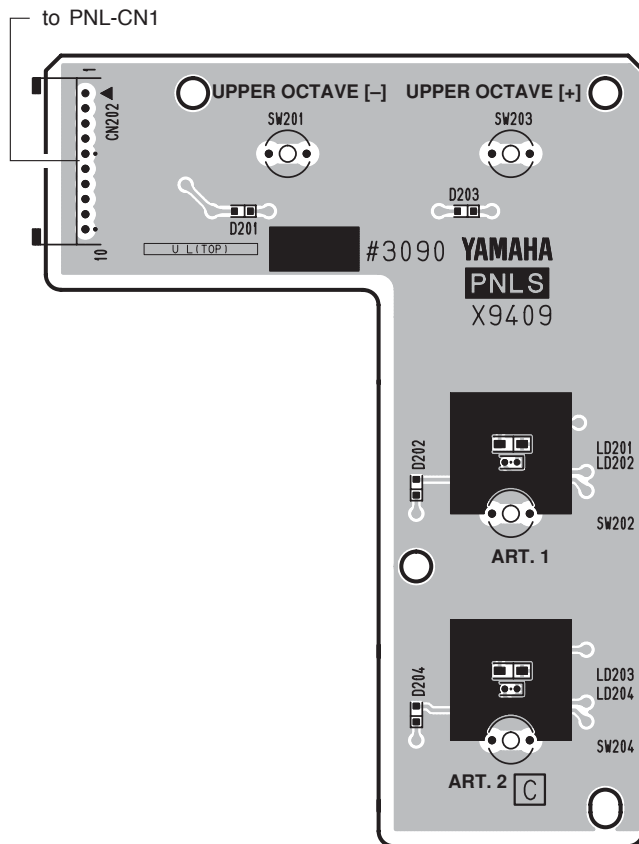


Component side

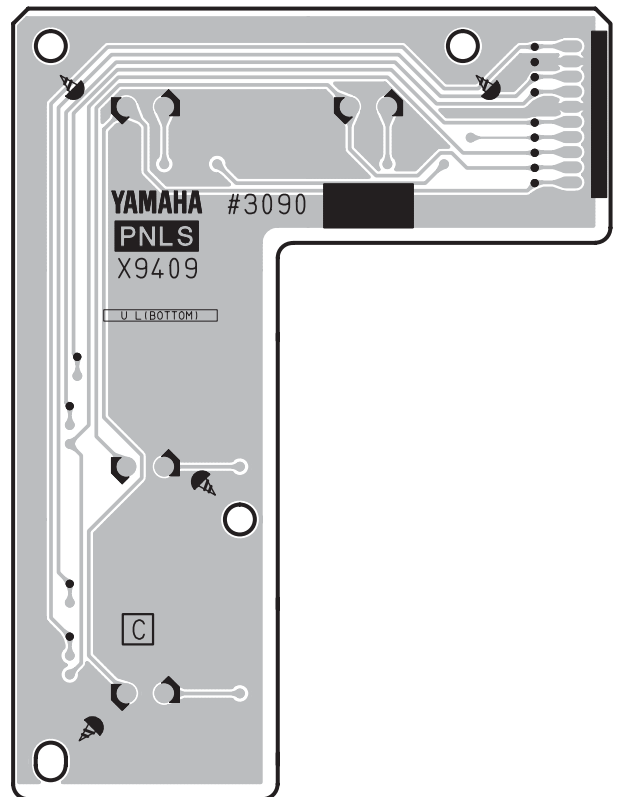


Pattern side

● PNLs Circuit Board

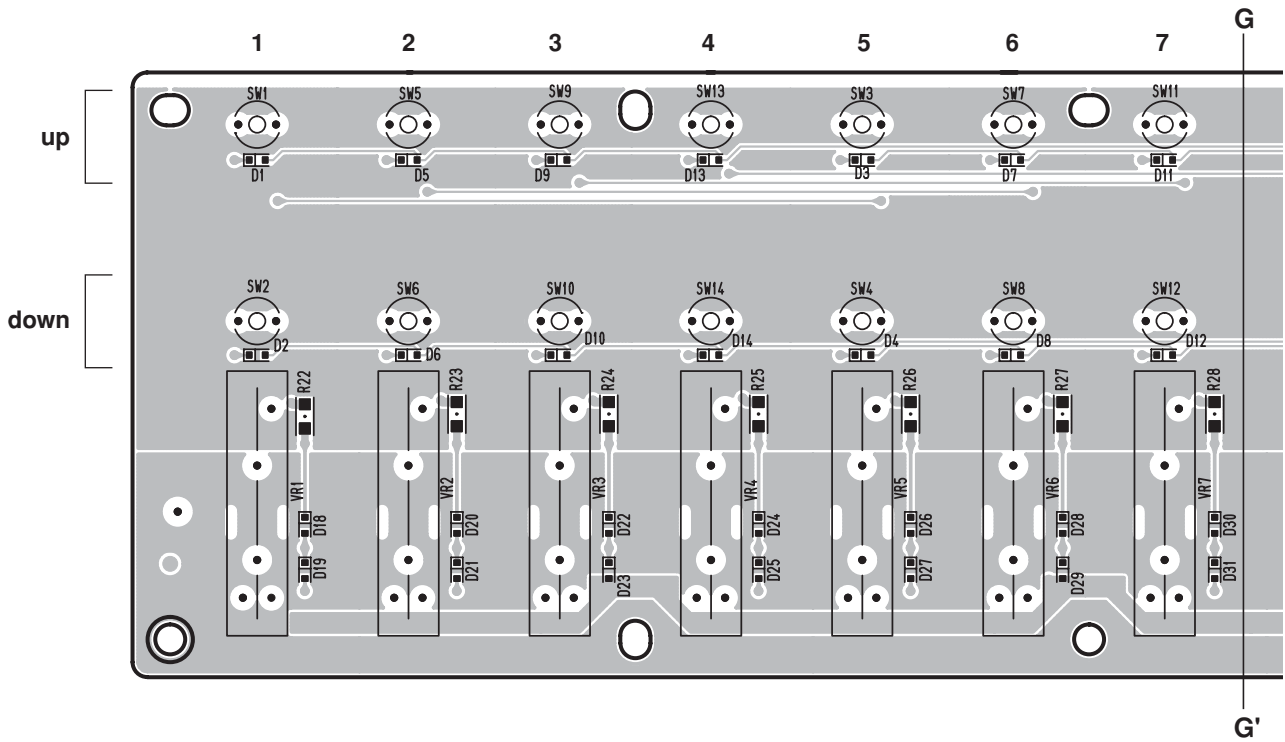


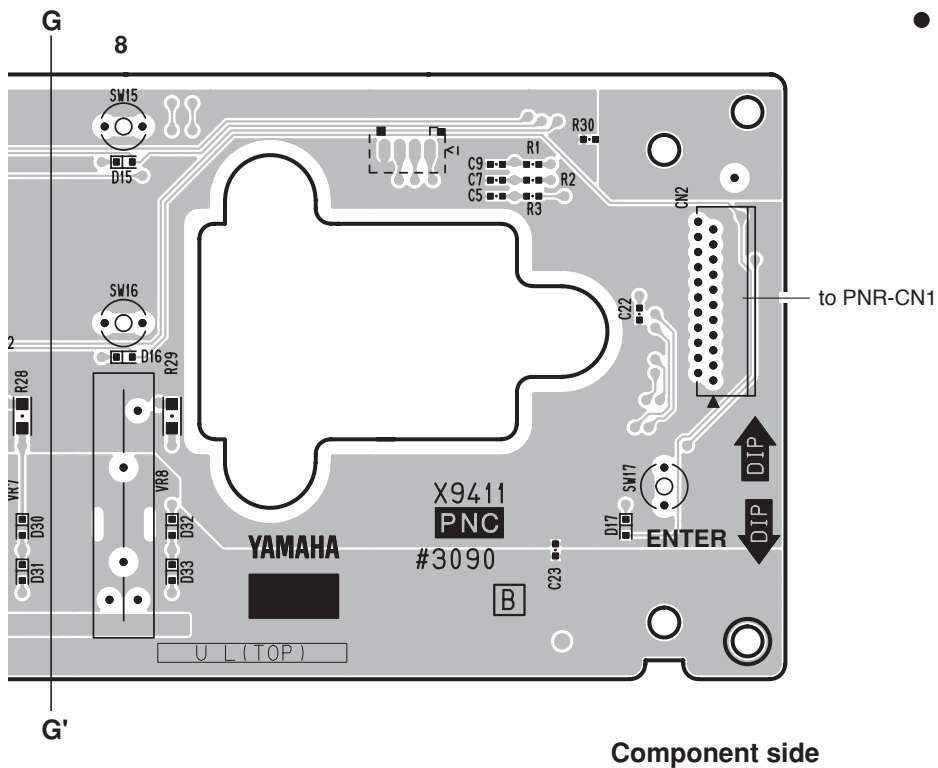
Component side



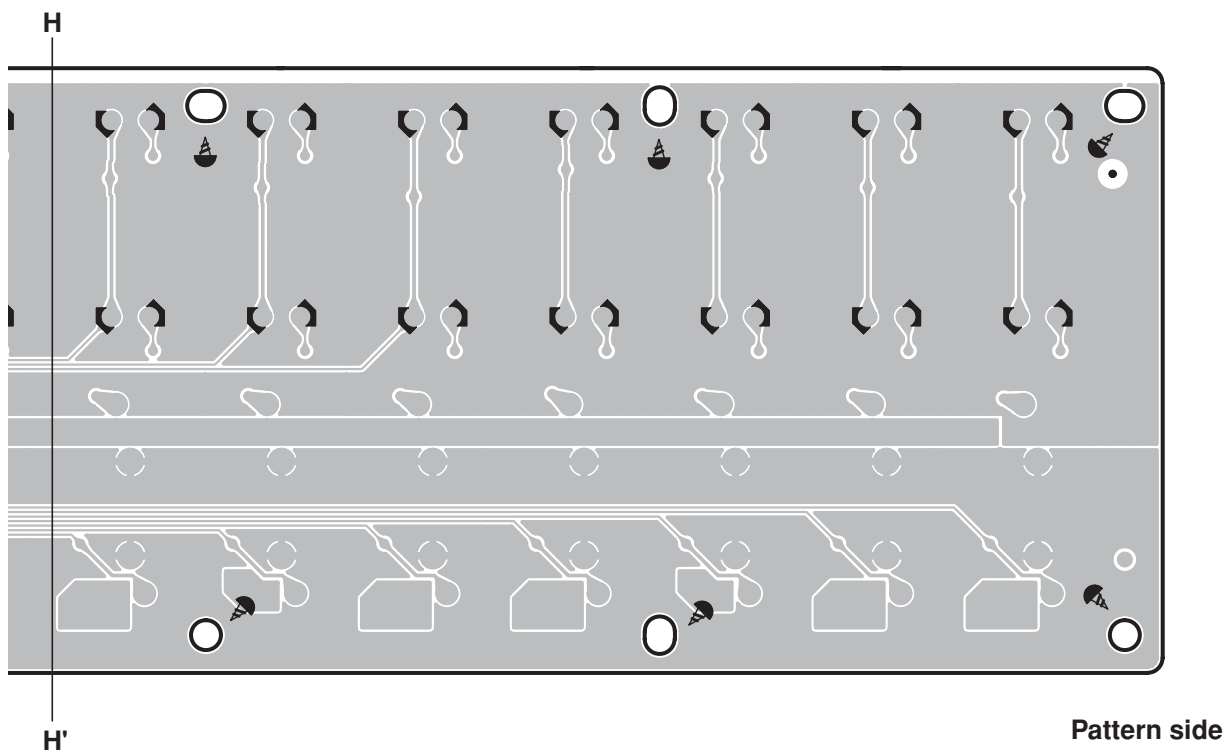
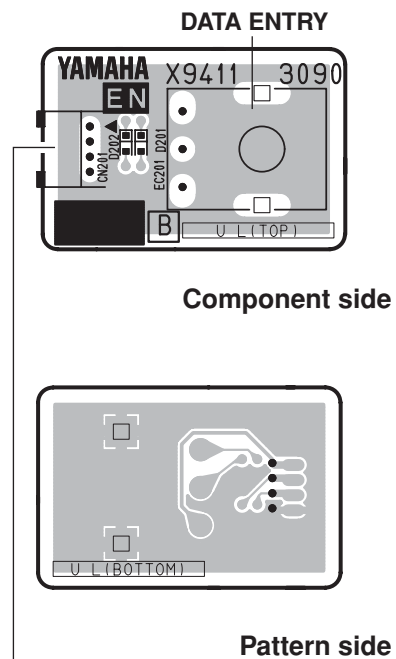
Pattern side

● PNC Circuit Board

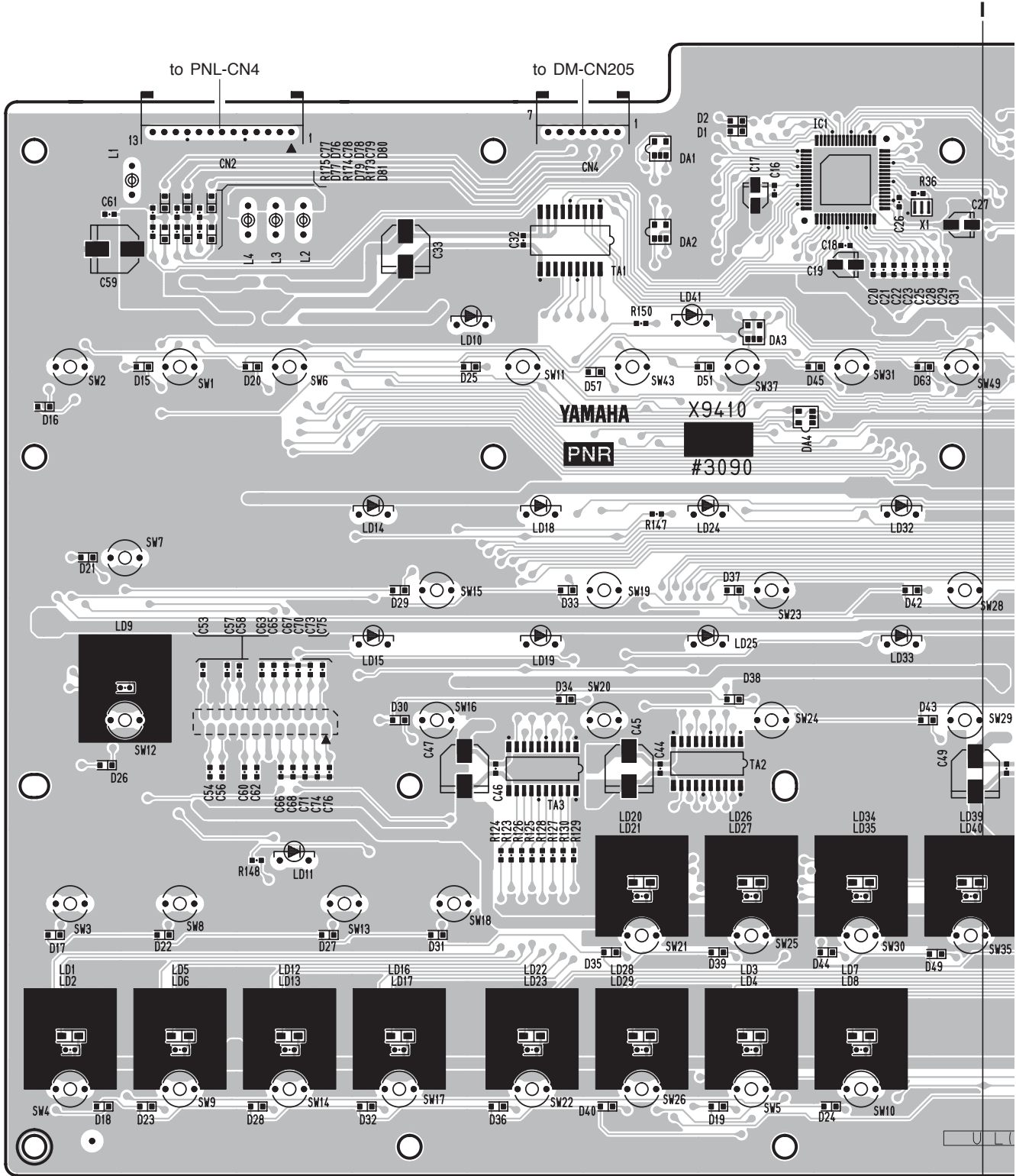


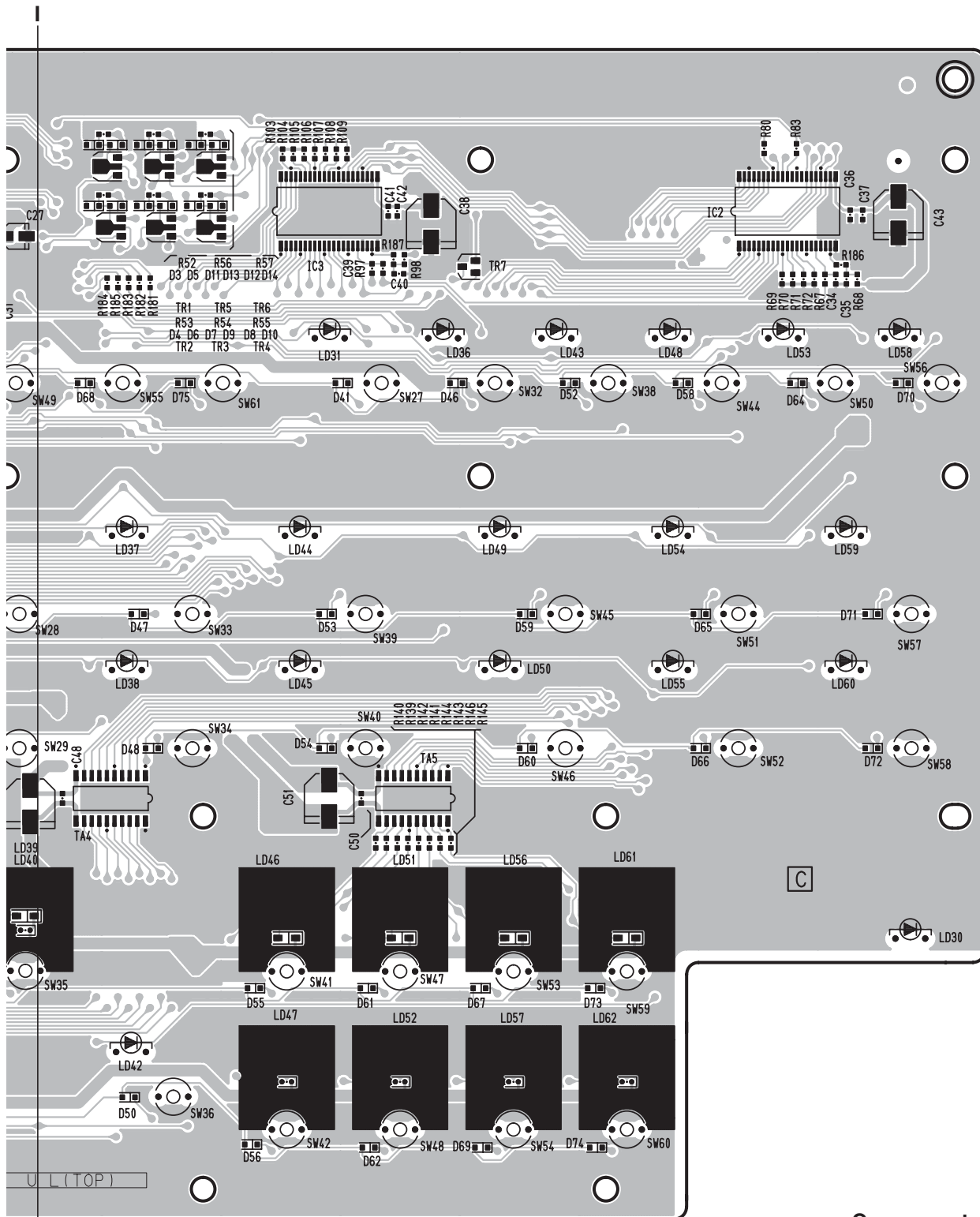


● EN Circuit Board



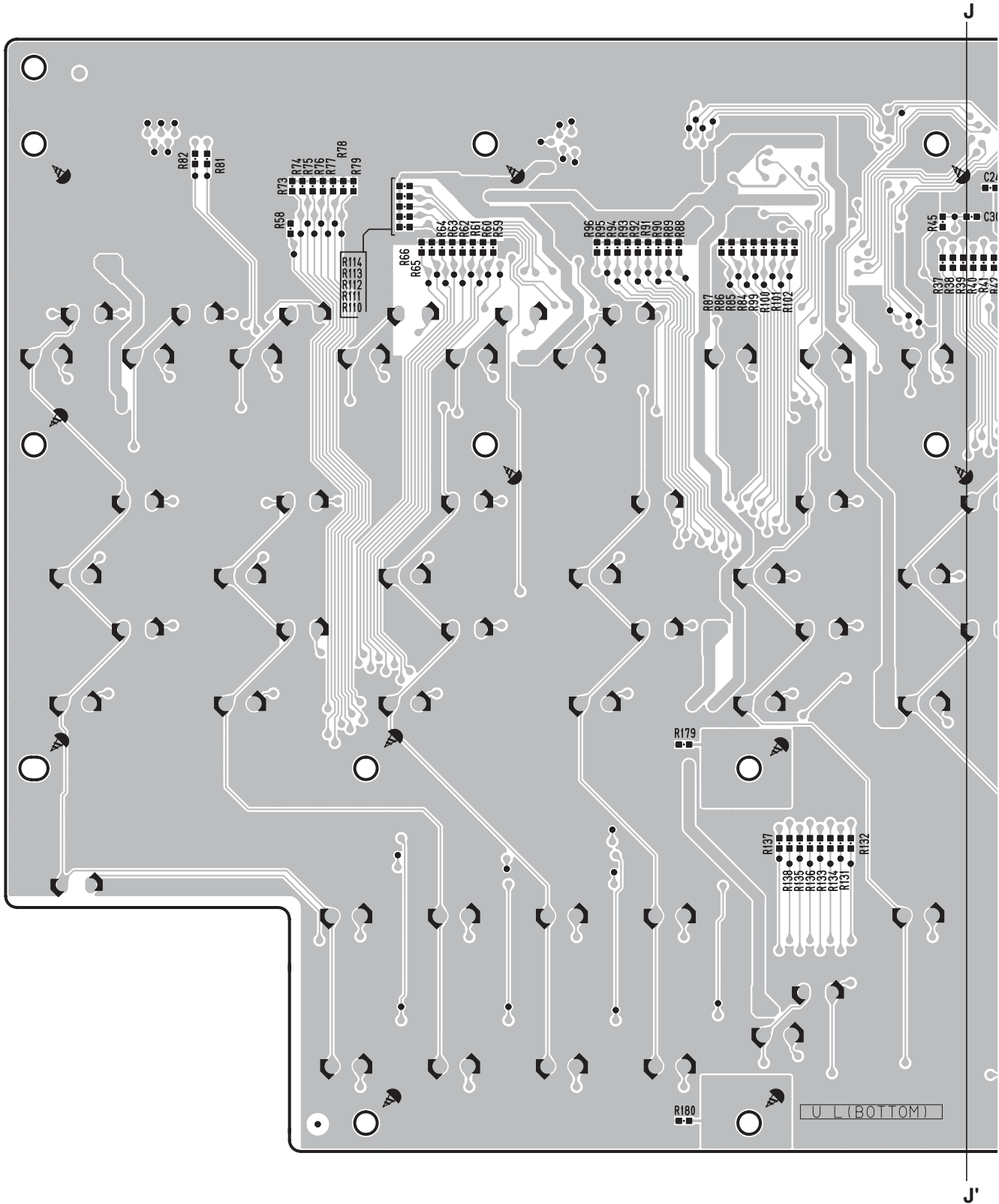
● PNR Circuit Board

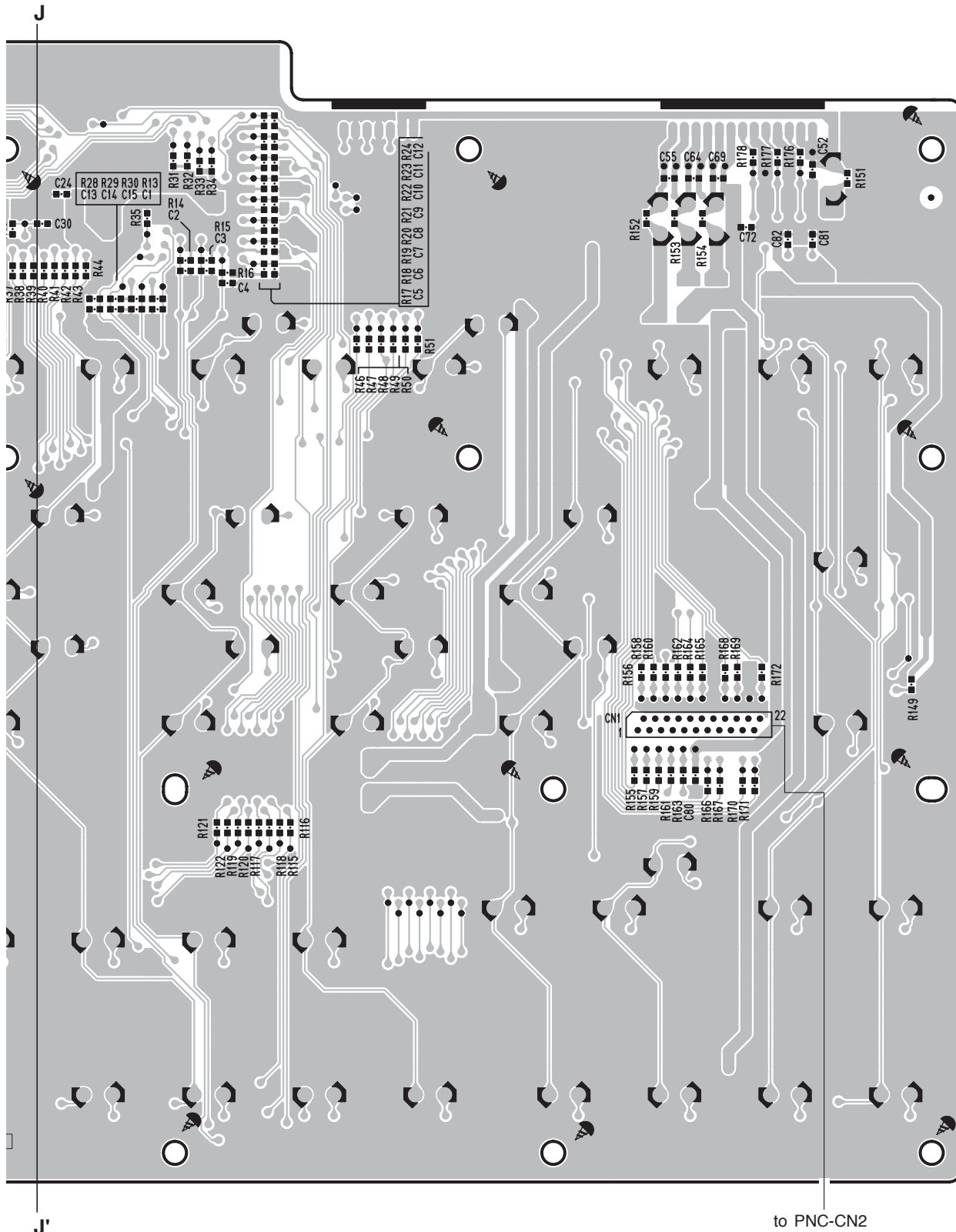




Component side

● PNR Circuit Board





to PNC-CN2

Pattern side

● PNR Circuit Board

<LED Name>

REF NO.	NAME
LD1	REGISTRATION MEMORY [1]
LD2	REGISTRATION MEMORY [1]
LD3	REGISTRATION MEMORY [7]
LD4	REGISTRATION MEMORY [7]
LD5	REGISTRATION MEMORY [2]
LD6	REGISTRATION MEMORY [2]
LD7	REGISTRATION MEMORY [8]
LD8	REGISTRATION MEMORY [8]
LD9	MUSIC FINDER
LD10	HARD DISK RECORDER [REC]
LD11	REG. MEMORY [FREEZE]
LD12	REGISTRATION MEMORY [3]
LD13	REGISTRATION MEMORY [3]
LD14	VOICE [PIANO]
LD15	VOICE [GUITAR]
LD16	REGISTRATION MEMORY [4]
LD17	REGISTRATION MEMORY [4]
LD18	VOICE [E.PIANO]
LD19	VOICE [BASS]
LD20	ONE TOUCH SETTING [1]
LD21	ONE TOUCH SETTING [1]
LD22	REGISTRATION MEMORY [5]
LD23	REGISTRATION MEMORY [5]
LD24	VOICE [ORGAN]
LD25	VOICE [PERC./DRUM KIT]
LD26	ONE TOUCH SETTING [2]
LD27	ONE TOUCH SETTING [2]
LD28	REGISTRATION MEMORY [6]
LD29	REGISTRATION MEMORY [6]
LD30	READ/WRITE
LD31	VOICE EFFECT [HARMONY/ECHO]
LD32	VOICE [STRINGS]
LD33	VOICE [ACCORDION]
LD34	ONE TOUCH SETTING [3]
LD35	ONE TOUCH SETTING [3]
LD36	VOICE EFFECT [INITIAL TOUCH]
LD37	VOICE [CHOIR]
LD38	VOICE [PAD]
LD39	ONE TOUCH SETTING [4]
LD40	ONE TOUCH SETTING [4]
LD41	HARD DISK RECORDER [PLAY/PAUSE]
LD42	PART ON/OFF [LEFT HOLD]
LD43	VOICE EFFECT [SUSTAIN]
LD44	VOICE [BRASS]
LD45	VOICE [SYNTH]
LD46	PART SELECT [LEFT]
LD47	PART ON/OFF [LEFT]
LD48	VOICE EFFECT [MONO]
LD49	VOICE [TRUMPET]
LD50	VOICE [ORGAN FLUTES]
LD51	PART SELECT [RIGHT 1]
LD52	PART ON/OFF [RIGHT 1]
LD53	VOICE EFFECT [DSP]
LD54	VOICE [SAXOPHONE]
LD55	VOICE [EXPANSION]
LD56	PART SELECT [RIGHT 2]
LD57	PART ON/OFF [RIGHT 2]
LD58	VOICE EFFECT [VARIATION]
LD59	VOICE [FLUTE/CLARINET]
LD60	VOICE [USER DRIVE]
LD61	PART SELECT [RIGHT 3]
LD62	PART ON/OFF [RIGHT 3]

<Switch Name>

REF NO.	NAME
SW1	MENU [VOICE CREATOR]
SW2	MENU [FUNCTION]
SW3	REGIST BANK [-]
SW4	REGISTRATION MEMORY [1]
SW5	REGISTRATION MEMORY [7]
SW6	MENU [DIGITAL RECORDING]
SW7	INTERNET
SW8	REGIST BANK [+]
SW9	REGISTRATION MEMORY [2]
SW10	REGISTRATION MEMORY [8]
SW11	HARD DISK RECORDER [REC]
SW12	MUSIC FINDER
SW13	REG. MEMORY [FREEZE]
SW14	REGISTRATION MEMORY [3]
SW15	VOICE [PIANO]
SW16	VOICE [GUITAR]
SW17	REGISTRATION MEMORY [4]
SW18	REG. MEMORY [MEMORY]
SW19	VOICE [E.PIANO]
SW20	VOICE [BASS]
SW21	ONE TOUCH SETTING [1]
SW22	REGISTRATION MEMORY [5]
SW23	VOICE [ORGAN]
SW24	VOICE [PERC./DRUM KIT]
SW25	ONE TOUCH SETTING [2]
SW26	REGISTRATION MEMORY [6]
SW27	VOICE EFFECT [HARMONY/ECHO]
SW28	VOICE [STRINGS]
SW29	VOICE [ACCORDION]
SW30	ONE TOUCH SETTING [3]
SW31	HARD DISK RECORDER [PREV]
SW32	VOICE EFFECT [INITIAL TOUCH]
SW33	VOICE [CHOIR]
SW34	VOICE [PAD]
SW35	ONE TOUCH SETTING [4]
SW36	PART ON/OFF [LEFT HOLD]
SW37	HARD DISK RECORDER [PLAY/PAUSE]
SW38	VOICE EFFECT [SUSTAIN]
SW39	VOICE [BRASS]
SW40	VOICE [SYNTH]
SW41	PART SELECT [LEFT]
SW42	PART ON/OFF [LEFT]
SW43	HARD DISK RECORDER [STOP]
SW44	VOICE EFFECT [MONO]
SW45	VOICE [TRUMPET]
SW46	VOICE [ORGAN FLUTES]
SW47	PART SELECT [RIGHT 1]
SW48	PART ON/OFF [RIGHT 1]
SW49	HARD DISK RECORDER [NEXT]
SW50	VOICE EFFECT [DSP]
SW51	VOICE [SAXOPHONE]
SW52	VOICE [EXPANSION]
SW53	PART SELECT [RIGHT 2]
SW54	PART ON/OFF [RIGHT 2]
SW55	HARD DISK RECORDER [SELECT]
SW56	VOICE EFFECT [VARIATION]
SW57	VOICE [FLUTE/CLARINET]
SW58	VOICE [USER DRIVE]
SW59	PART SELECT [RIGHT 3]
SW60	PART ON/OFF [RIGHT 3]
SW61	HARD DISK RECORDER [SETTING]

● PNL Circuit Board

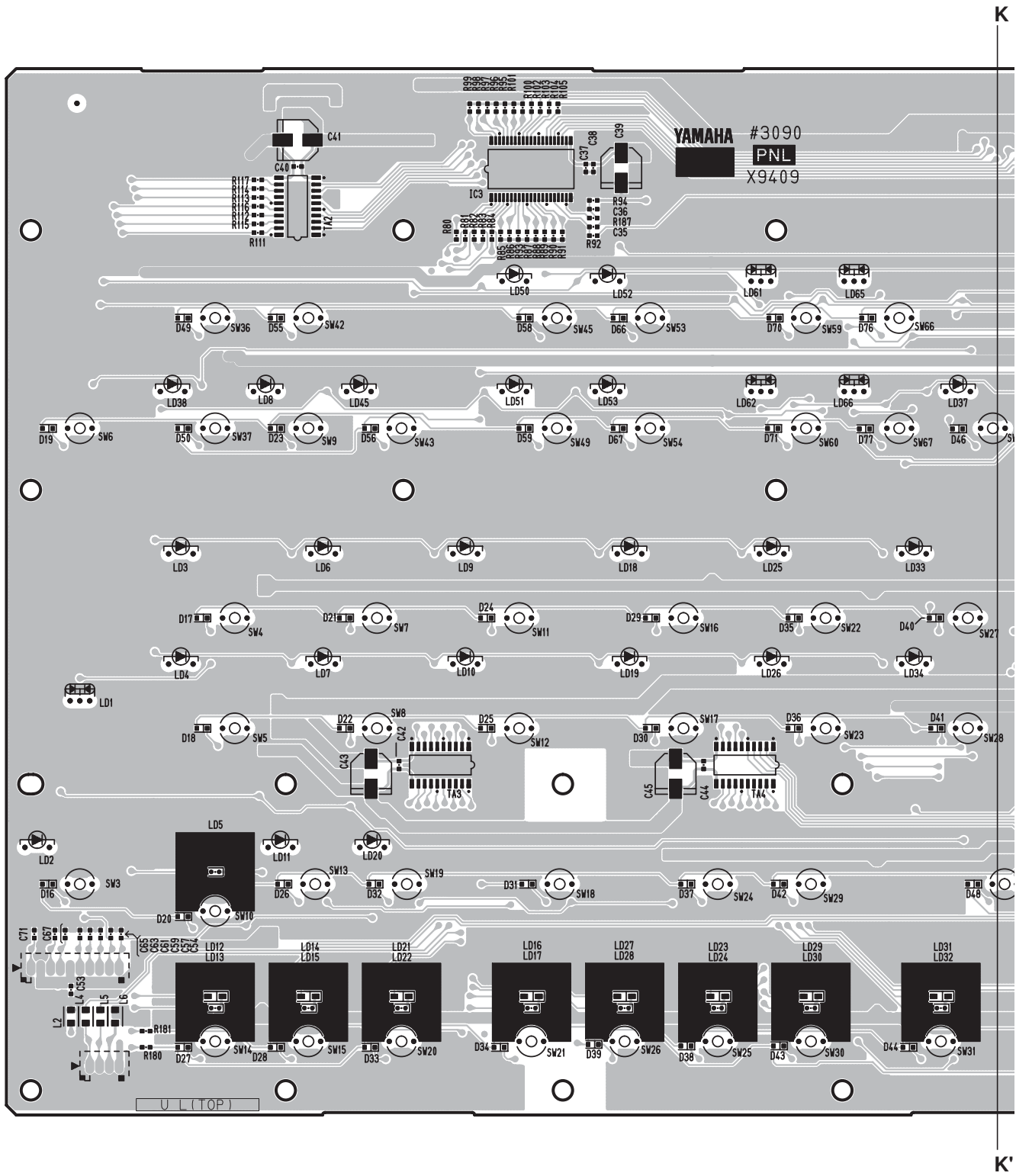
<LED Name>

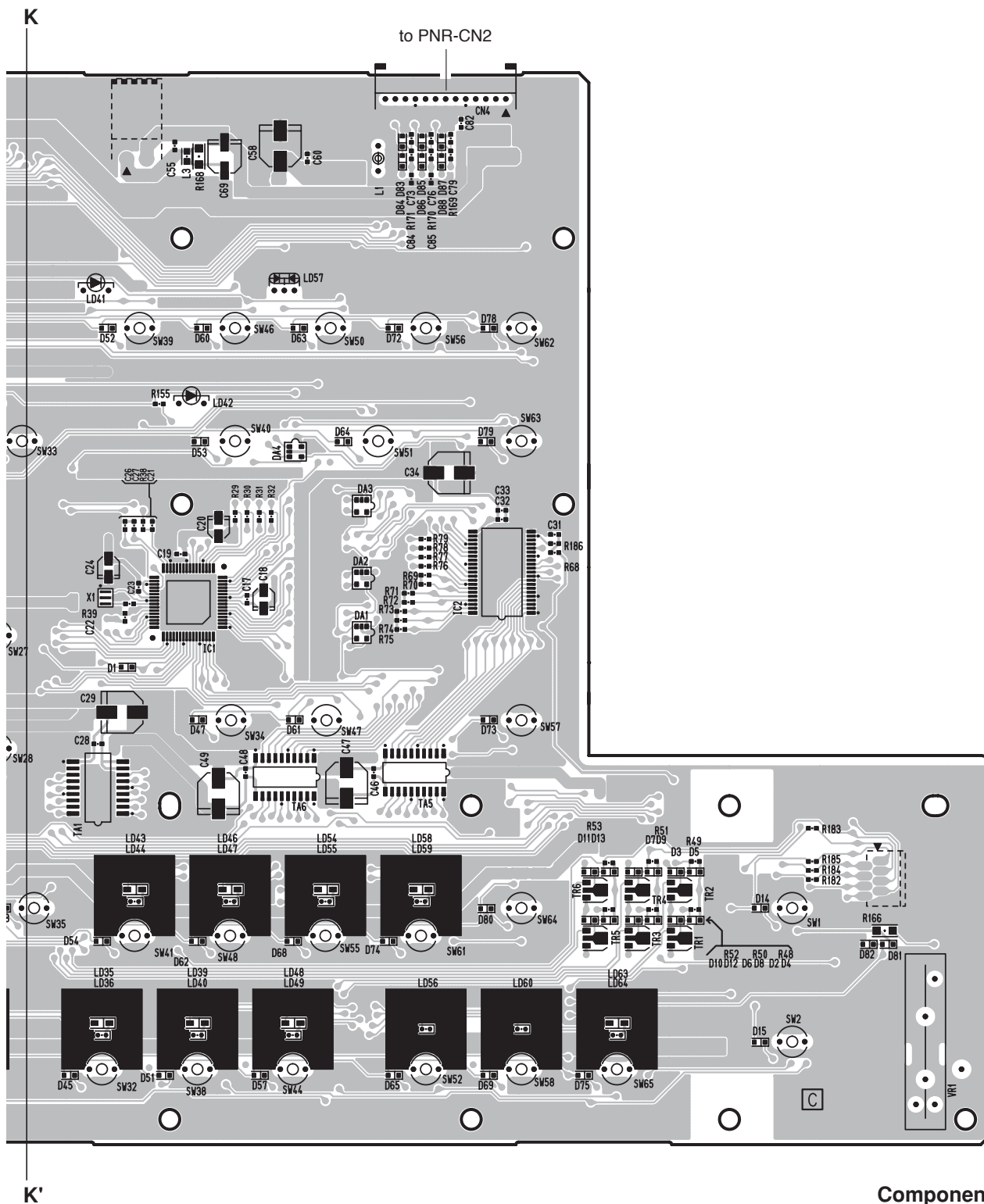
REF NO.	NAME
LD1	SIGNAL
LD2	FADE IN/OUT
LD3	STYLE [POP & ROCK]
LD4	STYLE [LATIN]
LD5	STYLE CONTROL [ACMP]
LD6	STYLE [BALLAD]
LD7	STYLE [BALLROOM]
LD8	MIC [EFFECT]
LD9	STYLE [DANCE]
LD10	STYLE [MOVIE & SHOW]
LD11	STYLE CONTROL [OTS LINK]
LD12	STYLE CONTROL INTRO [I]
LD13	STYLE CONTROL INTRO [I]
LD14	STYLE CONTROL INTRO [II]
LD15	STYLE CONTROL INTRO [II]
LD16	MAIN VARIATION [A]
LD17	MAIN VARIATION [A]
LD18	STYLE [SWING & JAZZ]
LD19	STYLE [ENTERTAINER]
LD20	STYLE CONTROL [AUTO FILL IN]
LD21	STYLE CONTROL INTRO [III]
LD22	STYLE CONTROL INTRO [III]
LD23	MAIN VARIATION [C]
LD24	MAIN VARIATION [C]
LD25	STYLE [R & B]
LD26	STYLE [WORLD]
LD27	MAIN VARIATION [B]
LD28	MAIN VARIATION [B]
LD29	MAIN VARIATION [D]
LD30	MAIN VARIATION [D]
LD31	STYLE CONTROL [BREAK]
LD32	STYLE CONTROL [BREAK]
LD33	STYLE [COUNTRY]
LD34	STYLE [FILE ACCESS]
LD35	ENDING/rit. [I]
LD36	ENDING/rit. [I]
LD37	SONG [LOOP]
LD38	MIC [VOCAL HARMONY]
LD39	ENDING/rit. [II]
LD40	ENDING/rit. [II]
LD41	SONG [REC]
LD42	SONG [METRONOME]
LD43	MULTI PAD CONTROL [1]
LD44	MULTI PAD CONTROL [1]
LD45	MIC [TALK]
LD46	MULTI PAD CONTROL [2]
LD47	MULTI PAD CONTROL [2]
LD48	ENDING/rit. [III]
LD49	ENDING/rit. [III]
LD50	SONG [I]
LD51	SONG [III]
LD52	SONG [II]
LD53	SONG [IV]
LD54	MULTI PAD CONTROL [3]
LD55	MULTI PAD CONTROL [3]
LD56	STYLE CONTROL [SYNC STOP]
LD57	SONG [PLAY/PAUSE]
LD58	MULTI PAD CONTROL [4]
LD59	MULTI PAD CONTROL [4]
LD60	STYLE CONTROL [SYNC START]
LD61	SONG [SP 1]
LD62	SONG [SP 3]
LD63	STYLE CONTROL [START/STOP]
LD64	STYLE CONTROL [START/STOP]
LD65	SONG [SP 2]
LD66	SONG [SP 4]

<Switch Name>

REF NO.	NAME
SW1	CHANNEL ON/OFF
SW2	BALANCE
SW3	FADE IN/OUT
SW4	STYLE [POP & ROCK]
SW5	STYLE [LATIN]
SW6	DEMO
SW7	STYLE [BALLAD]
SW8	STYLE [BALLROOM]
SW9	MIC [EFFECT]
SW10	STYLE CONTROL [ACMP]
SW11	STYLE [DANCE]
SW12	STYLE [MOVIE & SHOW]
SW13	STYLE CONTROL [OTS LINK]
SW14	STYLE CONTROL INTRO [I]
SW15	STYLE CONTROL INTRO [II]
SW16	STYLE [SWING & JAZZ]
SW17	STYLE [ENTERTAINER]
SW18	TAP TEMPO
SW19	STYLE CONTROL [AUTO FILL IN]
SW20	STYLE CONTROL INTRO [III]
SW21	MAIN VARIATION [A]
SW22	STYLE [R & B]
SW23	STYLE [WORLD]
SW24	TEMPO [-]
SW25	MAIN VARIATION [C]
SW26	MAIN VARIATION [B]
SW27	STYLE [COUNTRY]
SW28	STYLE [FILE ACCESS]
SW29	TEMPO [+]
SW30	MAIN VARIATION [D]
SW31	STYLE CONTROL [BREAK]
SW32	ENDING/rit. [I]
SW33	SONG [LOOP]
SW34	TRANSPOSE [-]
SW35	MULTI PAD CONTROL [SELECT]
SW36	MIC [VH TYPE SELECT]
SW37	MIC [VOCAL HARMONY]
SW38	ENDING/rit. [II]
SW39	SONG [REC]
SW40	SONG [METRONOME]
SW41	MULTI PAD CONTROL [1]
SW42	MIC [MIC SETTING]
SW43	MIC [TALK]
SW44	ENDING/rit. [III]
SW45	SONG [I]
SW46	SONG [STOP]
SW47	TRANSPOSE [+]
SW48	MULTI PAD CONTROL [2]
SW49	SONG [III]
SW50	SONG [PLAY/PAUSE]
SW51	SONG [LYRICS/TEXT]
SW52	STYLE CONTROL [SYNC STOP]
SW53	SONG [II]
SW54	SONG [IV]
SW55	MULTI PAD CONTROL [3]
SW56	SONG [REW]
SW57	MIXING CONSOLE
SW58	STYLE CONTROL [SYNC START]
SW59	SONG [SP 1]
SW60	SONG [SP 3]
SW61	MULTI PAD CONTROL [4]
SW62	SONG [FF]
SW63	SONG [SCORE]
SW64	MULTI PAD CONTROL [STOP]
SW65	STYLE CONTROL [START/STOP]
SW66	SONG [SP 2]
SW67	SONG [SP 4]

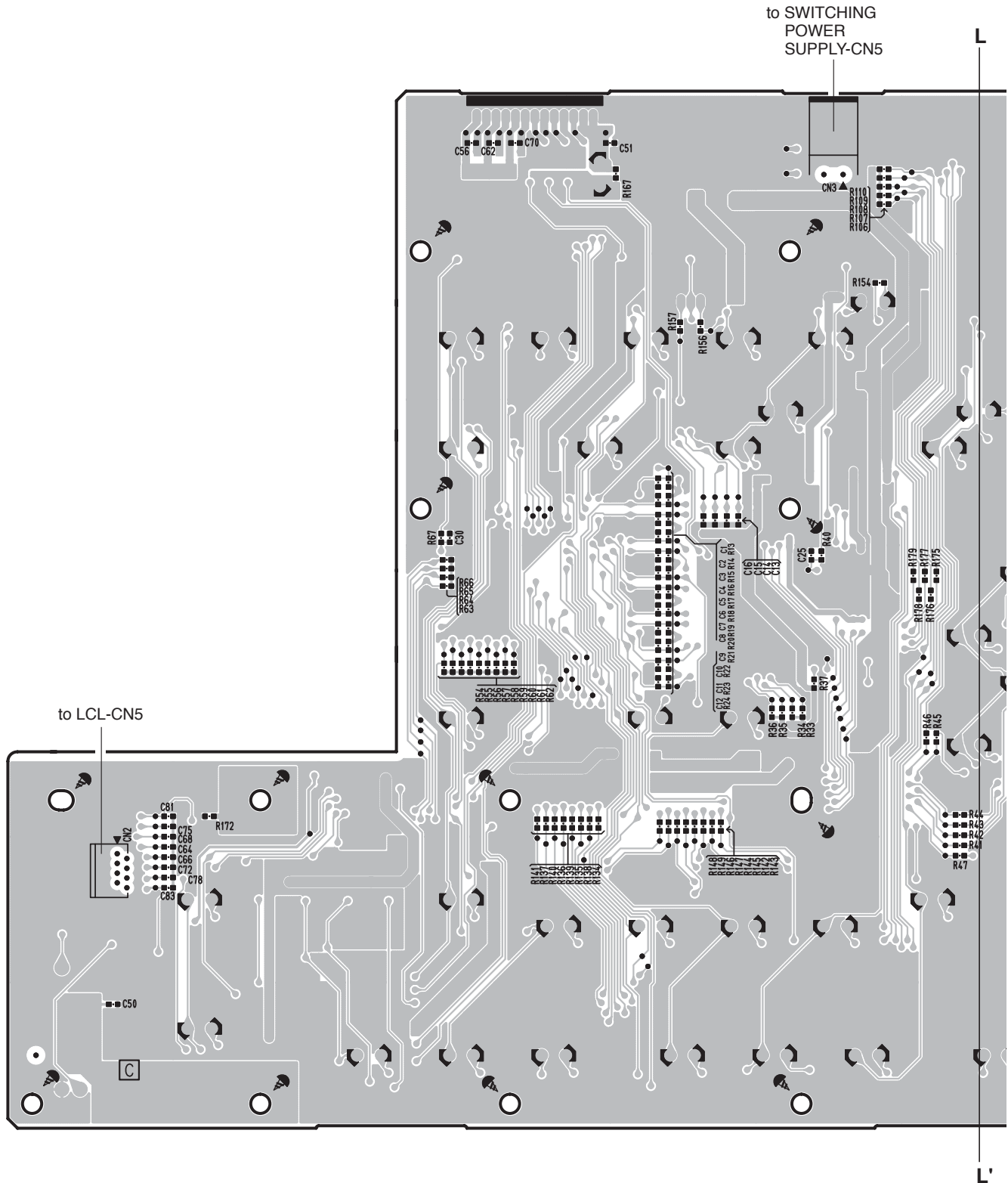
● PNL Circuit Board

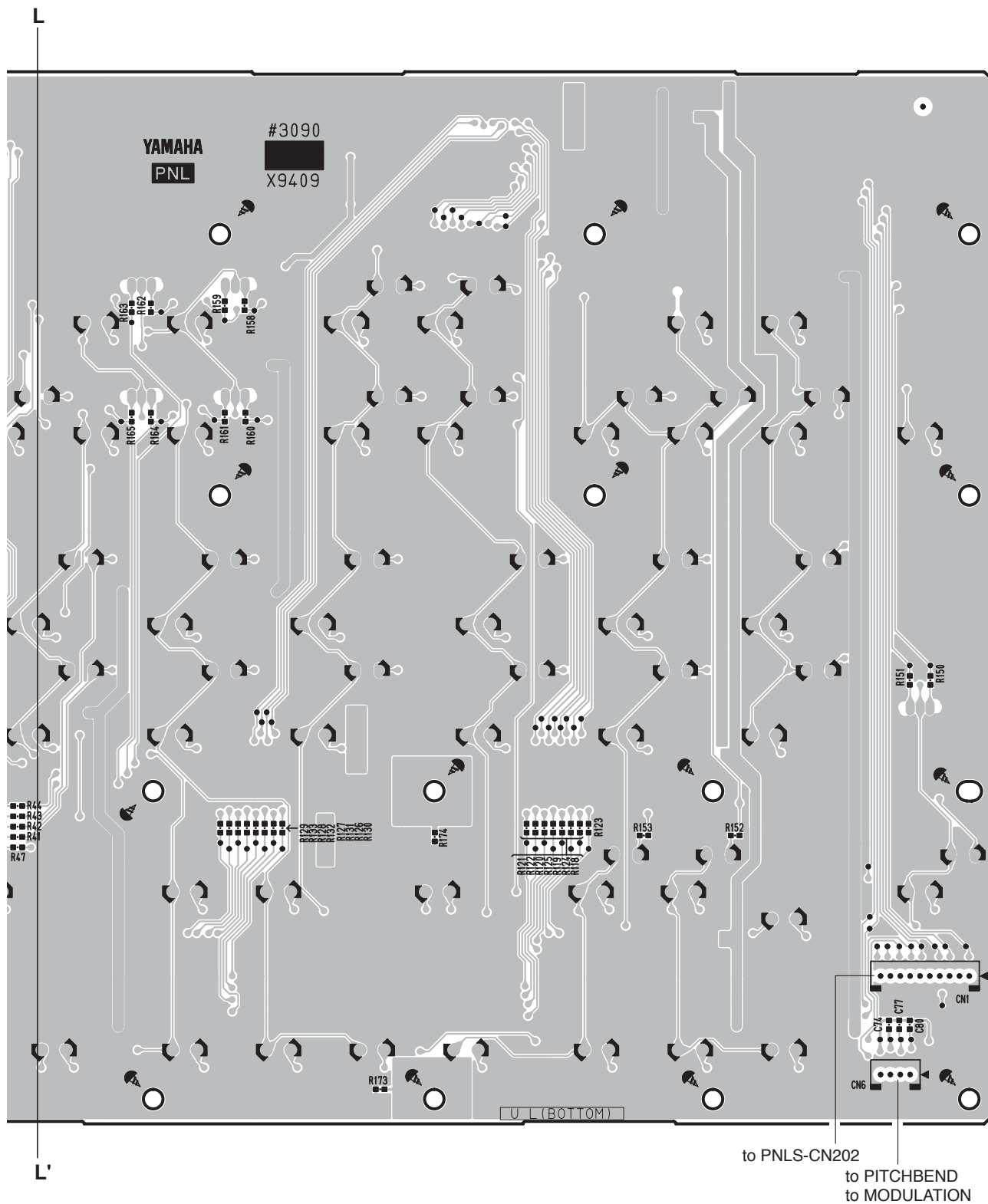




Component side

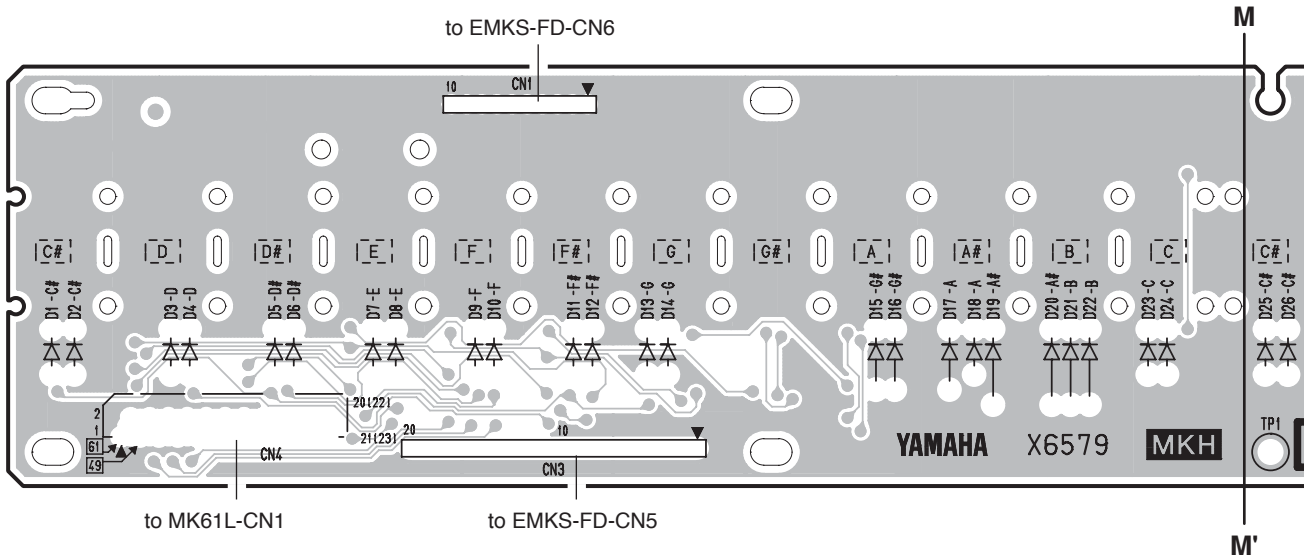
● PNL Circuit Board



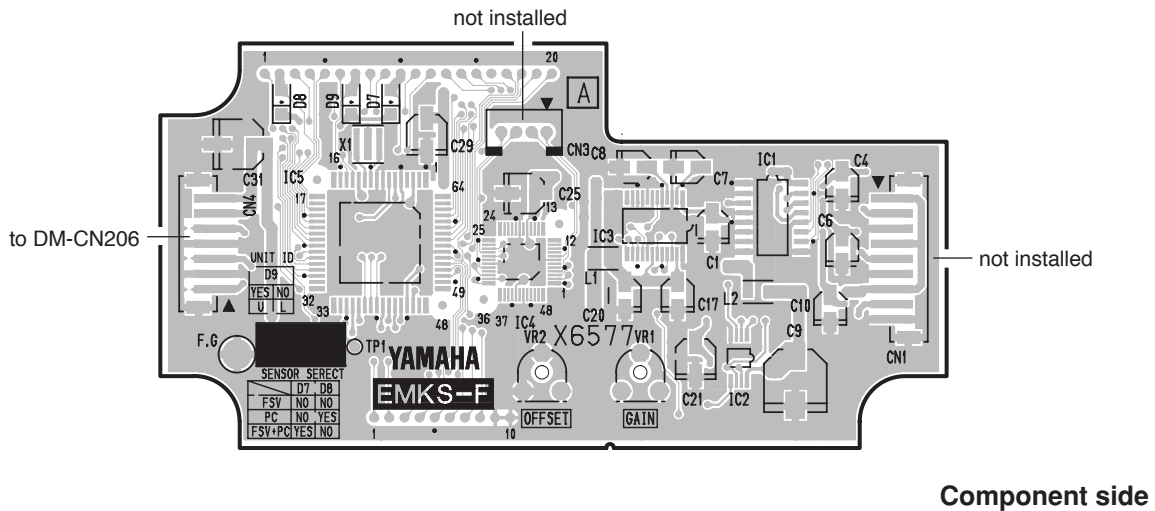


Pattern side

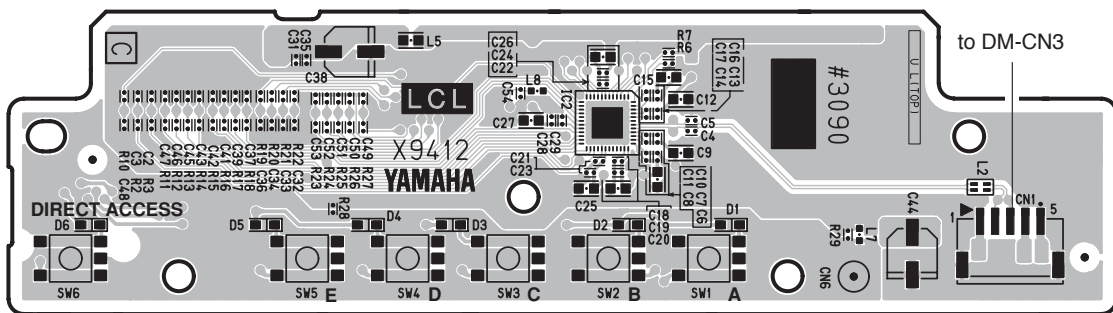
● MKH-D Circuit Board



● EMKS-FD Circuit Board




● LCL Circuit Board

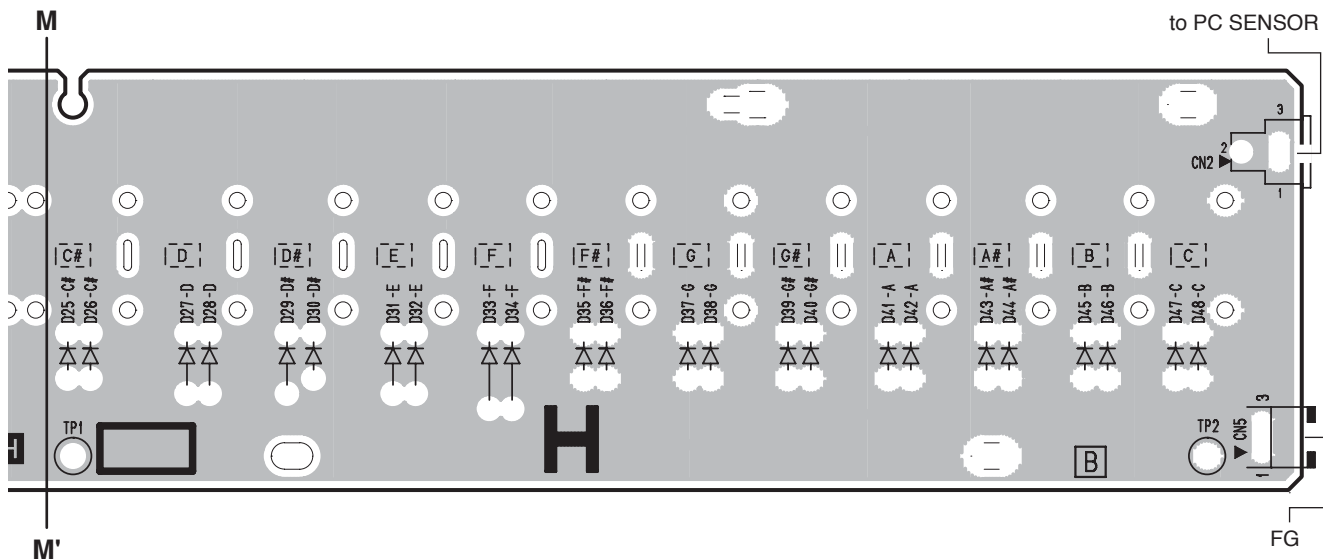


Component side

EMKS-FD: WE62240

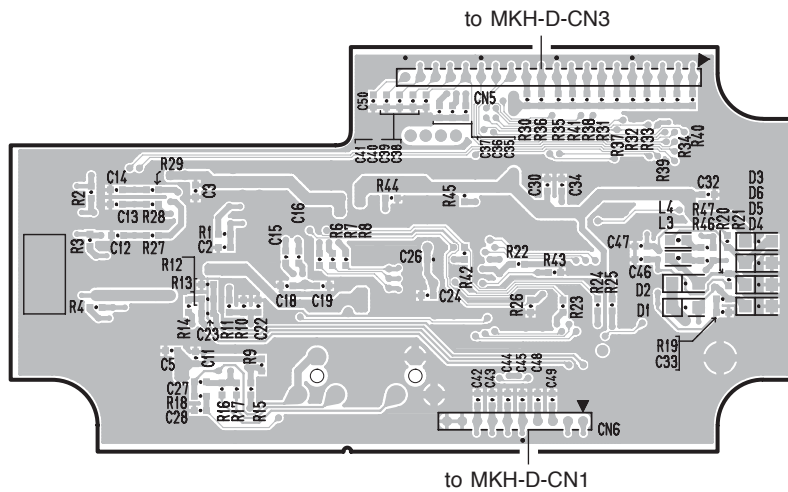
LCL: 2NA-WM24270

MKH-D: 2NAKZ-WD78540 



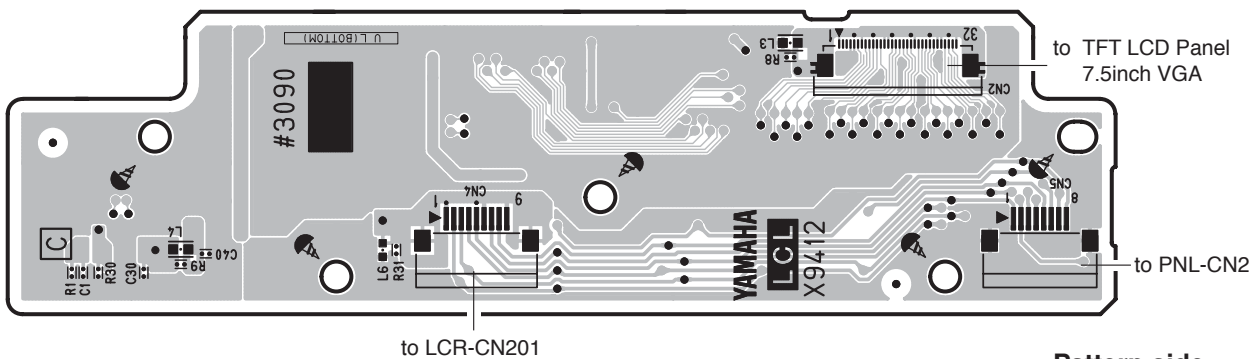
Component side

● EMKS-FD Circuit Board



Pattern side

● LCL Circuit Board



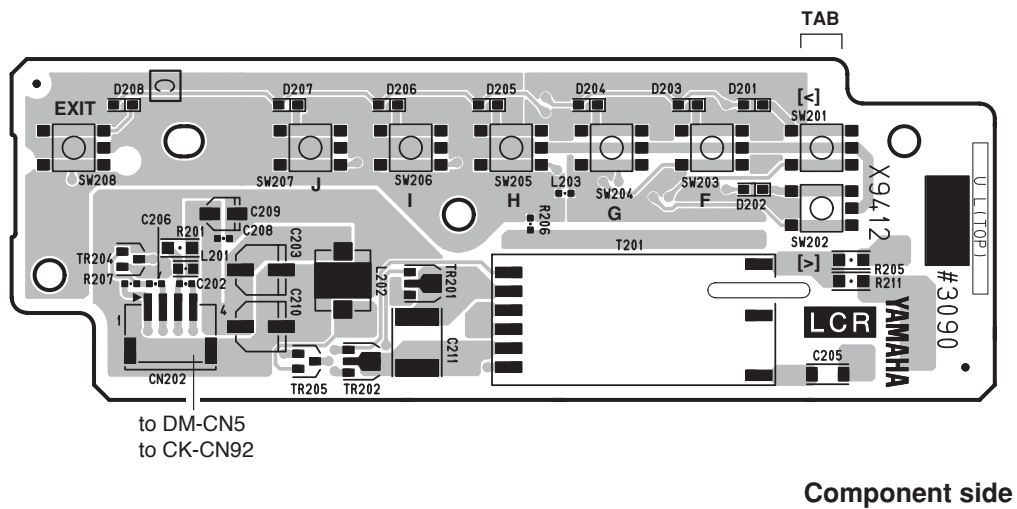
Pattern side

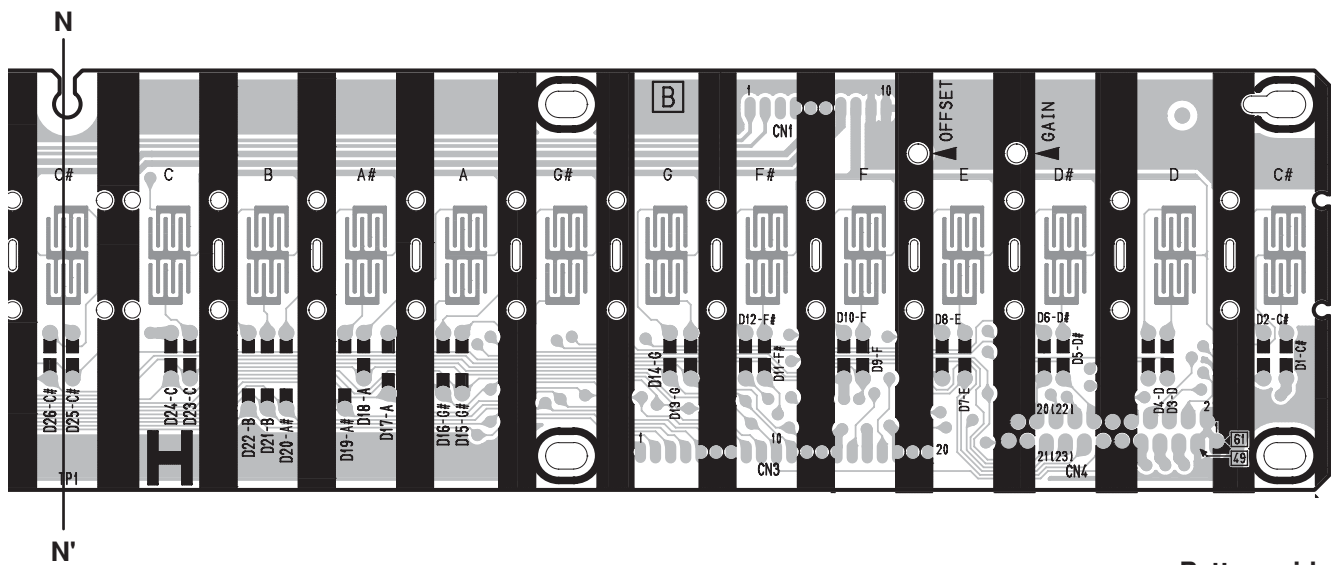
- EMKS-FD: WE62240
- LCL: 2NA-WM24270
- MKH-D: 2NAKZ-WD78540

● MKH-D Circuit Board



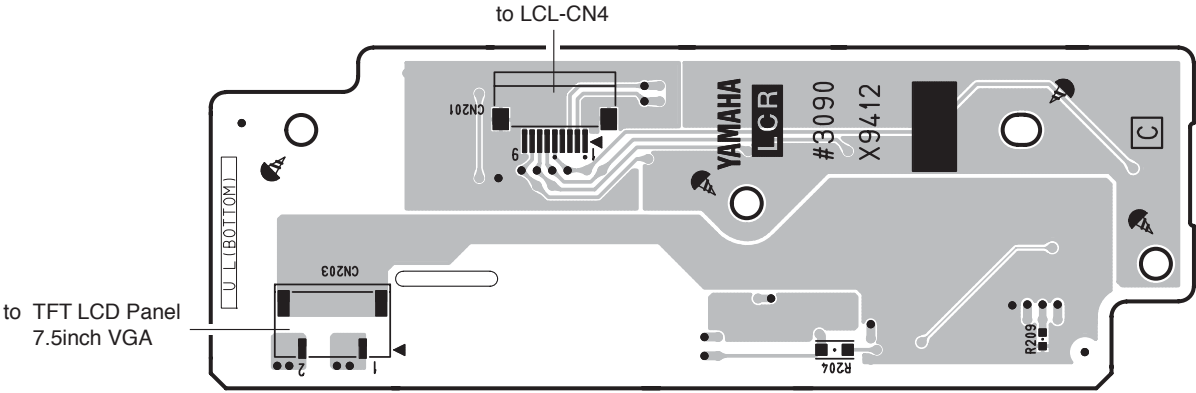
● LCR Circuit Board





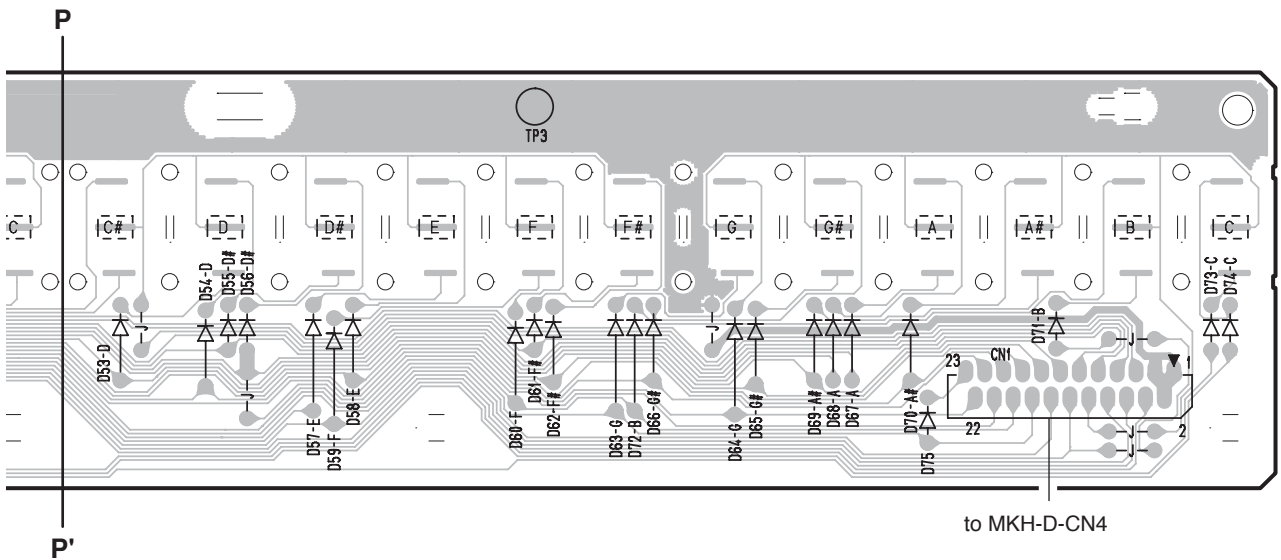
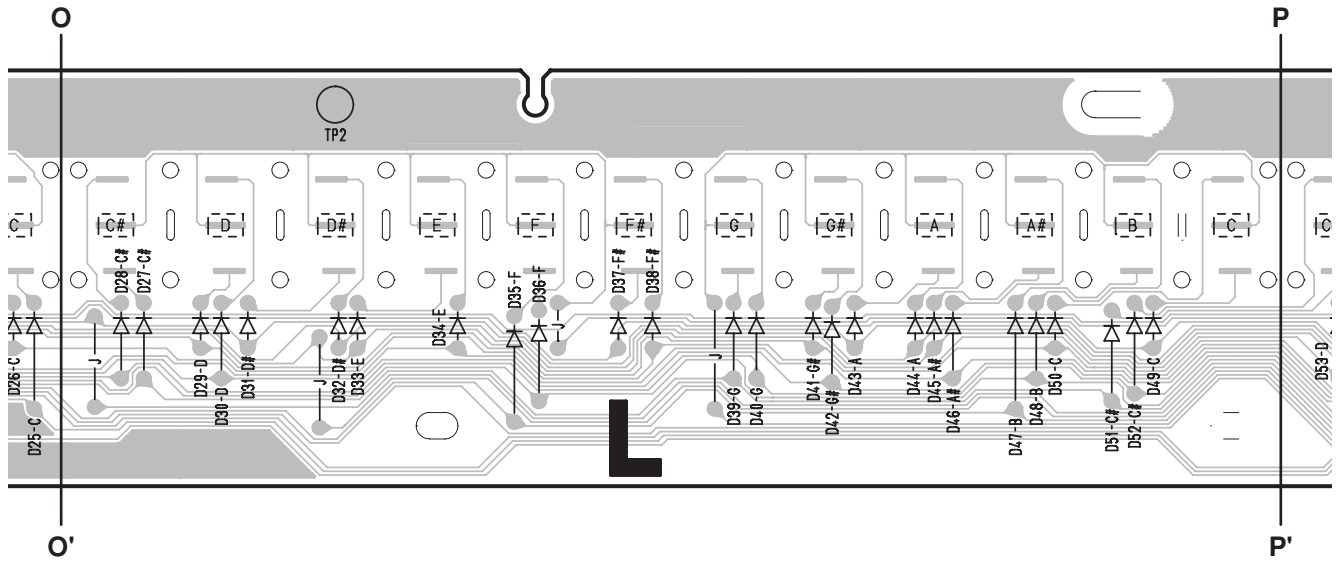
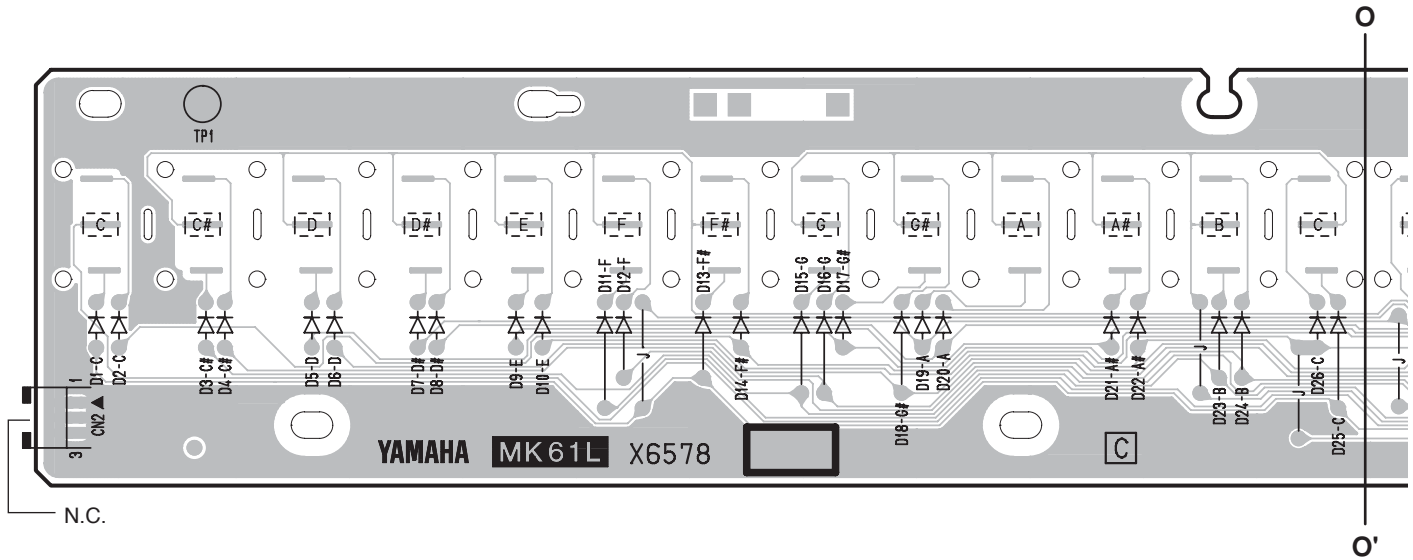
Pattern side

● LCR Circuit Board



Pattern side

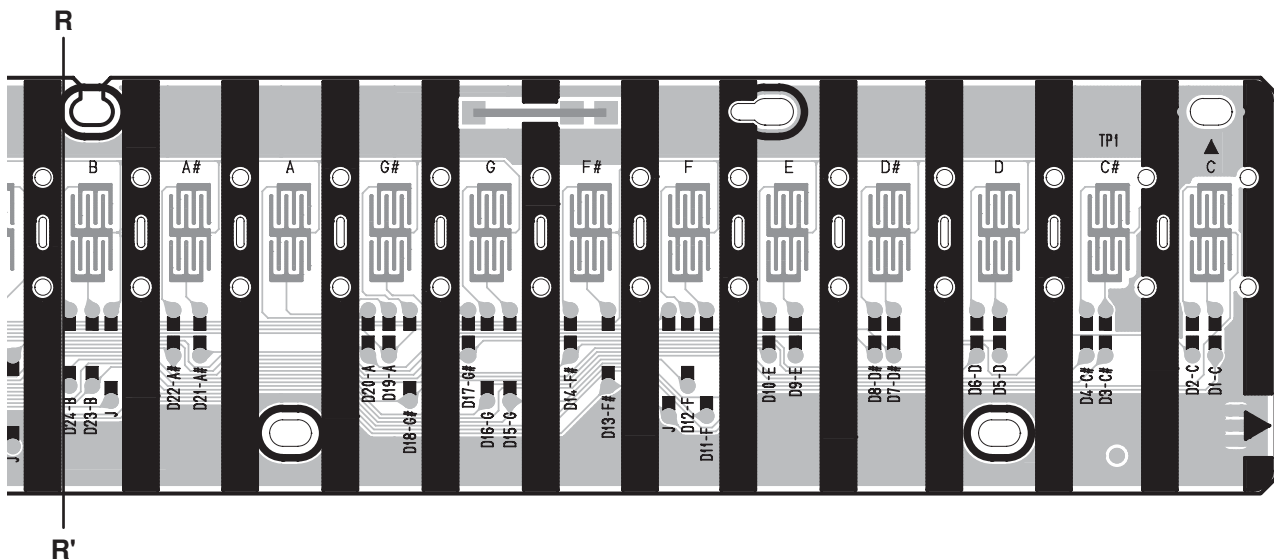
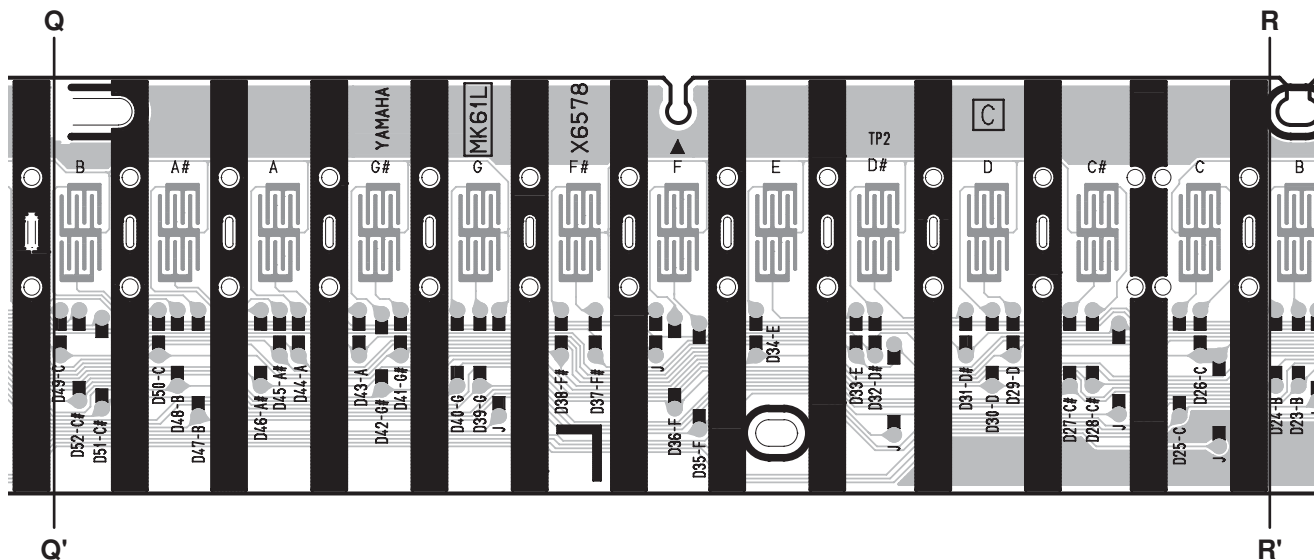
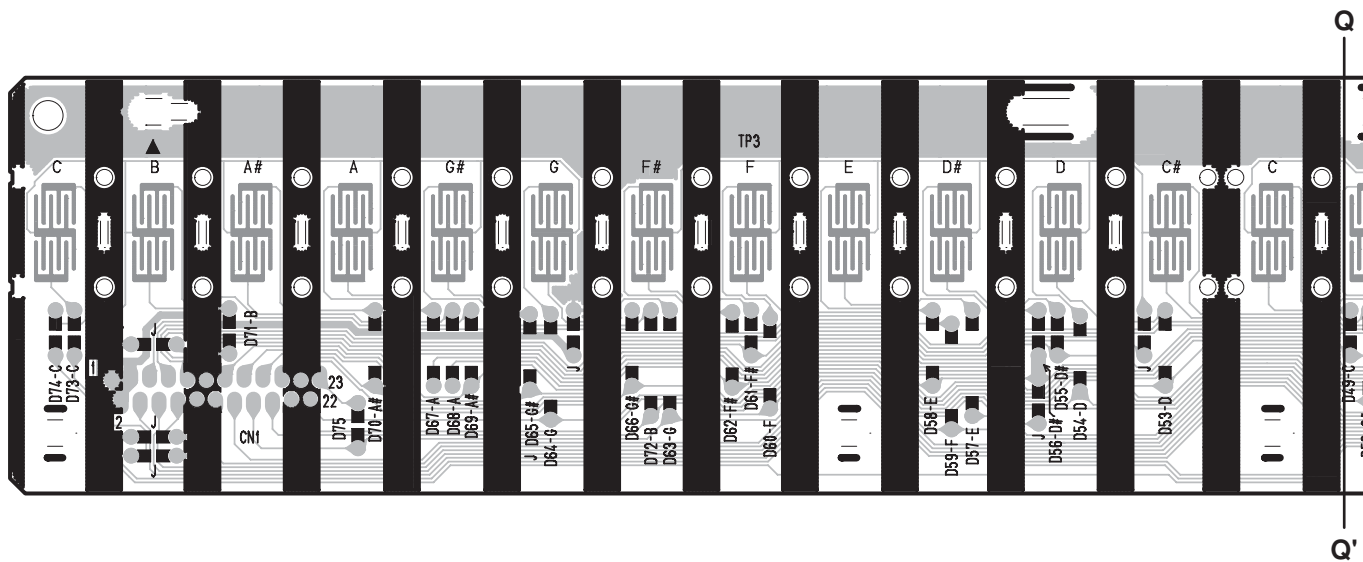
● MK61L Circuit Board



Component side

2NAKZ-WD80020

● MK61L Circuit Board



Pattern side

TEST PROGRAM

1 Measurement Conditions

1-1: Measuring Instruments

- Low-frequency oscillator
- Level meter (JIS-C curve)
- Frequency counter, which can detect hundredth value or more
- Oscilloscope

1-2: Jig

- Stereo PHONE jack cable (33 Ω or 30 Ω load)
- Monaural PHONE jack cable (10 k Ω load), 2 pcs. used simultaneously
- Mini DIN 8-pin cable (470 Ω load)
- Video cable (75 Ω coaxial)
- USB cable (type AB)
- Color CRT monitor (RGB input compatible)
- Microphone
- Optional speaker (TRS-MS02 or equivalent)
- DIMM (Transcend TS64ML64V6 (512 MB) or equivalent, Two same model type of 512 MB used simultaneously)
- USB-Storage device (YD-8U10, or any USB-Storage device with read/write enable compatible with USB2.0)
- MIDI cable, 2 pcs. used simultaneously
- Mini D-Sub15 pin RGB cable
- Color CRT monitor (NTSC and PAL system compatible)
- Foot pedal (FC7 or equivalent)
- Headphone

1-3: Others

- The tolerance shall be within ± 2 dB
- The unit for analog input/output level is as follows:
0 dBu = 0.775 Vrms

2 Starting up the test program

* Install two (2) DIMMs before turning on the power of Tyros3. (P. 26)

* Before starting checking, format the HDD referring to the “Formatting HDD” (P. 113).

Turn on the [POWER] switch while holding down the [C#2], [F2], and [G#2] keys (C#2 major code). (Fig. 1)

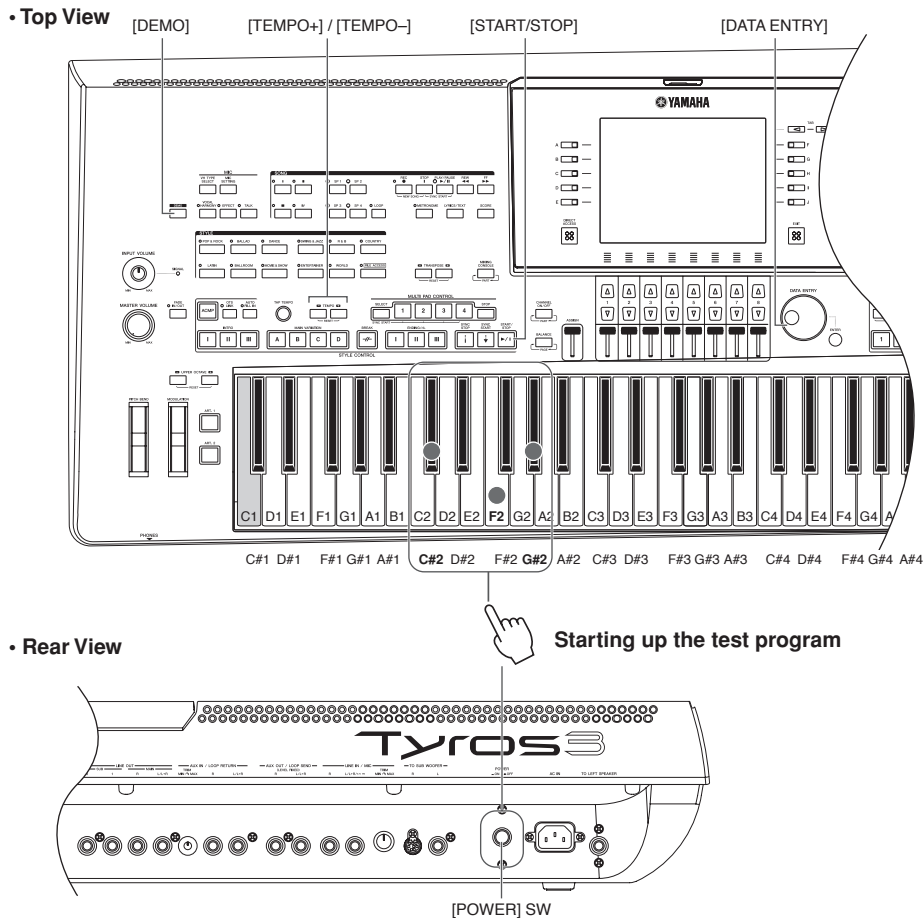


Fig. 1

Start-up screen (normal state)

```

TEST

Device Connection Check
[ DIMM ] : Device found
[ HDD ]  : Device found

```

Start-up screen (when an error is detected)

```

TEST
SwErr : 0A01, 0A02

Device Connection Check
[ DIMM ] : No Device
[ HDD ]  : No Device

```

“SwErr”

(A panel switch is being pressed. Displays up to two codes for panel switch held down in four figures in hexadecimal notation.)

“[DIMM] : No Device”

(No DIMM is installed.)

“[HDD] : No Device”

(No HDD is installed.)

2-1: How to carry out tests

- 1) When the test program is started, **“TEST”** will be displayed.
 - 2) To increase test item number: Press the [TEMPO+] button or turn the [DATA ENTRY] dial clockwise. (Fig. 1)
 To decrease test item number: Press the [TEMPO-] button or turn the [DATA ENTRY] dial counterclockwise. (Fig. 1)
 To execute the test: Press the [START/STOP] button once. (Fig. 1)
 Indication of "--" underneath of each test items is shown as progressing the test and in case of asterisks "*" is shown as progress bar when the test takes time such as "Flash Check1,2", "Wave ROM Check 2" etc.
- If the test result is OK:
 Press the [START/STOP] button again to go back to the item selection display. (Fig. 1)
 - If the test result is NG:
 Press the lowest key (C1) on the keyboard or the [DEMO] button to go back to the item selection display. (Fig. 1)
 ([START/STOP] button is ineffective in case of NG)

• Test Program Item List

Number	Check item	Displayed Message	Automatic check
1	Version indication	Version	X
2	Simplified check of ROM	ROM Check1	O
3	Simplified check of RAM	RAM Check1	O
4	Simplified check of Backup Flash ROM	BACKUP ROM Check1	O
5	Simplified check of Wave ROM	Wave ROM Check1	O
6	Simplified check of Wave RAM (SDRAM)	Wave RAM(SDRAM) Check1	O
7	Simplified check of Wave RAM (DIMM)	Wave RAM(DIMM) Check1	O
8	Simplified check of Effect RAM	Effect RAM Check1	O
9	Sound check of Tone Generator 1	TG 1 Check	X
10	Sound check of Tone Generator 2	TG 2 Check	X
11	Pitch check	Pitch Check	X
12	Output Level R check	Output R Check	X
13	Output Level L check	Output L Check	X
14	Output Level Sub-1 check	Output Sub-1 Check	X
15	Output Level Sub-2 check	Output Sub-2 Check	X
16	EQ (Low) frequency check	EQ Low Check	X
17	EQ (Mid) frequency check	EQ Mid Check	X
18	EQ (High) frequency check	EQ High Check	X
19	SP MUTE check	SP MUTE Check	X
20	MUTE check	MUTE Check	X
21	MIC L check	MIC L Check	X
22	MIC R check	MIC R Check	X
23	SW, LED check	SW,LED Check	X
24	All Panel LEDs On check	All LED On Check	X
25	Red LEDs On check	Red LED On Check	X
26	Green LEDs On check	Green LED On Check	X
27	Other colors LEDs On check	Other LED On Check	X
28	Whole LCD On check	All LCD On Check	X
29	Whole LCD Off check	All LCD Off Check	X
30	LCD pattern check	LCD Pattern Check	X
31	Pitch Bend Wheel check	Pitch Bend Wheel Check	O
32	Modulation Wheel check	Modulation Wheel Check	O
33	Slider check	Slider Check	O
34	Pedal 1 check	Pedal 1 Check	O
35	Pedal 2 check	Pedal 2 Check	O
36	Pedal 3 check	Pedal 3 Check	O
37	MIDI check	MIDI Check	O
38	Loop Send/Return check	Loop Send/Return Check	X
39	Sub Out connection check	Sub Out Check	O
40	Video Out check (NTSC RGB)	Video Out NTSC RGB	X
41	Video Out check (PAL RGB)	Video Out PAL RGB	X
42	RGB Out check	RGB Out Check	X
43	USB to Device/Host check	USB to Device/Host Check	O
44	USB Storage Device check	USB Storage Device Check	O
45	LAN check	LAN Check	O
46	DGA (HDD) check	DGA (HDD) Check	O
47	DGA (TG) check	DGA (TG) Check	X
48	Keyboard Type check	KeyboardType Check	O
49	Touch check	Touch Check	O
50	Full check of ROM	ROM Check2	O
51	Full check of RAM	RAM Check2	O
52	Full check of Backup Flash ROM	BACKUP ROM Check2	O
53	Full check of Wave ROM	Wave ROM Check2	O
54	Full check of Wave RAM (SDRAM)	Wave RAM (SDRAM) Check2	O
55	Full check of Wave RAM (DIMM)	Wave RAM (DIMM) Check2	O
56	Full check of Effect RAM	Effect RAM Check2	O
57	Panel PCB check (PNL)	Panel PCB Check (PNL)	X
58	Panel PCB check (LCL)	Panel PCB Check (LCL)	X
59	Panel PCB check (LCR)	Panel PCB Check (LCR)	X
60	Panel PCB check (PNC)	Panel PCB Check (PNC)	X
61	Panel PCB check (PNR)	Panel PCB Check (PNR)	X
62	Panel PCB check (LCL/R/C)	Panel PCB Check (LCL/R/C)	X
63	Factory Set	Factory Set	X
64	Test Exit	Test Exit	X

Test 1

Function: Version indication

Description:

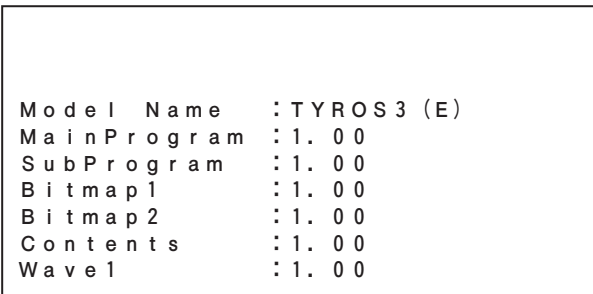
Displays version of program/data.

Use the TAB [◀]/[▶] keys to switch between plural pages.

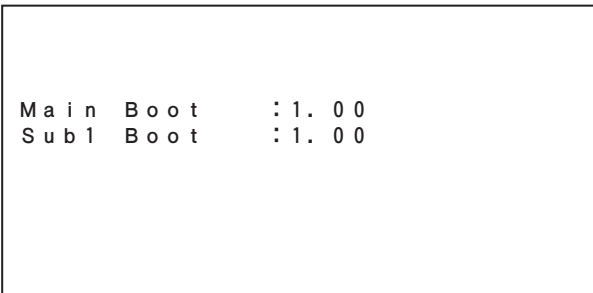
Displayed Message:



Selected screen



Page 1 (Example)



Page 2

Supplement:

Indicates model name (destination) and program/data versions.

"0.00" will be shown if the version is not recognized correctly.

Test 2

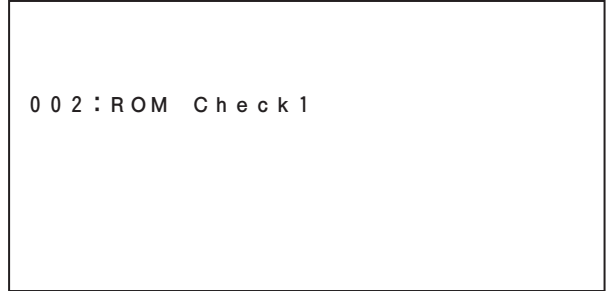
Function: Simplified check of ROM

Description:

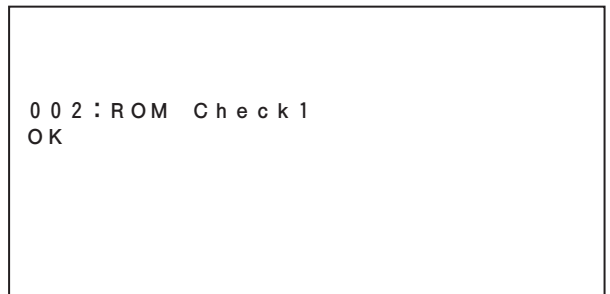
Executes Read test (checksum test) of ROM.

Executes Write pin check of Program Flash ROM as well.

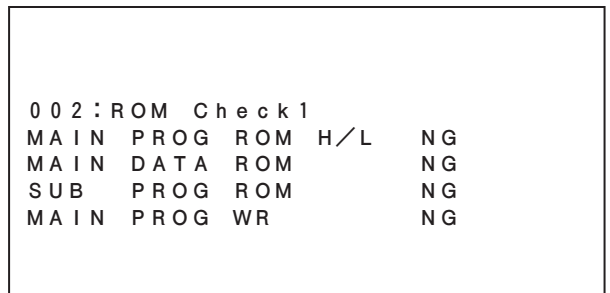
Displayed Message:



Selected screen



In case of OK



In case of NG (Example)

Supplement:

In case of NG, name of the ROM of which NG is detected will be shown.

"No Card" will be shown if SUB PROG is not detected.

Error Indications	Circuit Board	Location	Name in Circuit Diagram
MAIN PROG ROM H/L NG	DM	IC10	MAIN PROG-L 256 M FLASH
MAIN PROG WR NG		IC11	MAIN PROG-H 256 M FLASH
MAIN DATA ROM NG	DM	IC14	DATA ROM 64 M
SUB PROG ROM NG	DM	IC514	SUB BOOT ROM 8 M
SUB PROG ROM No Card			

Test 3

Function: Simplified check of RAM

Description:

Executes Read/Write test (connection check) of RAM.

Displayed Message:

```
0 0 3 : R A M   C h e c k 1
```

Selected screen

```
0 0 3 : R A M   C h e c k 1
O K
```

In case of OK

```
0 0 3 : R A M   C h e c k 1
M a i n   S D R A M   N G
S u b   S D R A M       N G
```

In case of NG

Supplement:

Location of NG will be shown in case of NG.

If sound board is not recognized, **"No Card"** will be shown for SUB SDRAM.

Error Indications	Circuit Board	Location	Name in Circuit Diagram
Main SDRAM NG	DM	IC12	SDRAM 256 M
		IC13	SDRAM 256 M
Sub SDRAM NG	DM	IC513	MAIN RAM 128 M SDRAM
Sub SDRAM No Card			

Test 4

Function: Simplified check of Backup ROM

Description:

Executes Read/Write test (connection check) of Backup Flash ROM. It will take about 9 seconds for the check.

* The check cannot be aborted until OK/NG result is indicated.

Displayed Message:

```
0 0 4 : B A C K U P   R O M   C h e c k 1
```

Selected screen

```
0 0 4 : B A C K U P   R O M   C h e c k 1
O K
```

In case of OK

```
0 0 4 : B A C K U P   R O M   C h e c k 1
N G
```

In case of NG

Supplement:

The check cannot be aborted until OK/NG result is indicated. Original data will be written back after the test is executed. Do not turn off the power during checking or the data will be lost.

Error Indications	Circuit Board	Location	Name in Circuit Diagram
NG	DM	IC15	BACKUP 64 M FLASH

Test 5

Function: Simplified check of Wave ROM

Description:

Executes Read test (checksum test) of Wave ROM.

Displayed Message:

```
0 0 5 : W a v e   R O M   C h e c k 1
```

Selected screen

```
0 0 5 : W a v e   R O M   C h e c k 1
O K
```

In case of OK

```
0 0 5 : W a v e   R O M   C h e c k 1
N G
```

In case of NG

Error Indications	Circuit Board	Location	Name in Circuit Diagram
NG	DM	IC800	WAVE ROM L1 512 M MASK
		IC801	WAVE ROM L2 512 M MASK
		IC802	WAVE ROM H1 512 M MASK
		IC803	WAVE ROM H2 512 M MASK

Test 6

Function: Simplified check of Wave RAM (SDRAM)

Description:

Executes simplified address checksum test of SDRAM for wave.

Displayed Message:

```
0 0 6 : W a v e   R A M   ( S D R A M )   C h e c k 1
```

Selected screen

```
0 0 6 : W a v e   R A M   ( S D R A M )   C h e c k 1
O K
```

In case of OK

```
0 0 6 : W a v e   R A M   ( S D R A M )   C h e c k 1
W a v e   S D R A M   ( T G 1 )   N G
W a v e   S D R A M   ( T G 2 )   N G
```

In case of NG

```
0 0 6 : W a v e   R A M   ( S D R A M )   C h e c k 1
W a v e   S D R A M   ( T G 1 )   N o   C a r d
W a v e   S D R A M   ( T G 2 )   N o   C a r d
```

In case no sound board is recognized

Supplement:

Check from TG1 → SWP51B Master (DM: IC505),

TG2 → SWP51B Slave (DM: IC506).

Error Indications	Circuit Board	Location	Name in Circuit Diagram
Wave SDRAM(TG1) NG	DM	IC511	SAMPLING RAM-L 16 M SDRAM
Wave SDRAM(TG2) NG			
Wave SDRAM(TG1) No Card			
Wave SDRAM(TG2) No Card			
		IC512	SAMPLING RAM-H 16 M SDRAM

Test 7

Function: Simplified check of Wave RAM (DIMM)

Description:

Executes simplified address checksum test of DIMM for wave. Indicates DIMM size as well.

Displayed Message:

```
0 0 7 : W a v e   R A M ( D I M M )   C h e c k 1
```

Selected screen

```
0 0 7 : W a v e   R A M ( D I M M )   C h e c k 1
O K ( D I M M H :   * * * M B , L :   * * * M B )
```

In case of OK (Indicates DIMM size in MB)

```
0 0 7 : W a v e   R A M ( D I M M )   C h e c k 1
N G ( D I M M H :   * * * M B , L :   * * * M B )
W a v e D I M M ( T G 1 ) N G
W a v e D I M M ( T G 2 ) N G
```

In case of NG (Indicates DIMM size in MB)

Supplement:

Check from TG1 → SWP51B Master (DM: IC505),

TG2 → SWP51B Slave (DM: IC506).

OK will be shown if DIMM connection is confirmed. Visually check DIMM size.

Test 8

Function: Simplified check of Effect RAM

Description:

Checks RAM that works for Effect.

Displayed Message:

```
0 0 8 : E f f e c t   R A M   C h e c k 1
```

Selected screen

```
0 0 8 : E f f e c t   R A M   C h e c k 1
O K
```

In case of OK

```
0 0 8 : E f f e c t   R A M   C h e c k 1
T G 1   N G
T G 2   O K
```

In case of NG

Supplement:

TG1 indicates Effect RAM of SWP51B Master (DM: IC505)

and TG2 indicates Effect RAM of SWP51B Slave (DM: IC506).

Error Indications	Circuit Board	Location	Name in Circuit Diagram
TG1 NG	DM	IC508	WORK RAM 64 M SDRAM
TG2 NG	DM	IC509	WORK RAM 64 M SDRAM

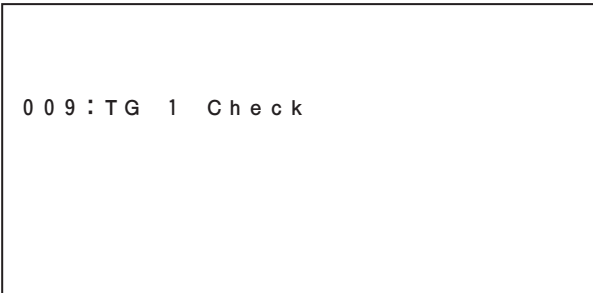
Test 9

Function: Sound check of the Tone Generator 1

Description:

Sequentially outputs sounds starting from lower keys by switching the channel of the sound source at the SWP51B Master side for checking sound generator and sound. Check that there is no abnormal sounds or noise.

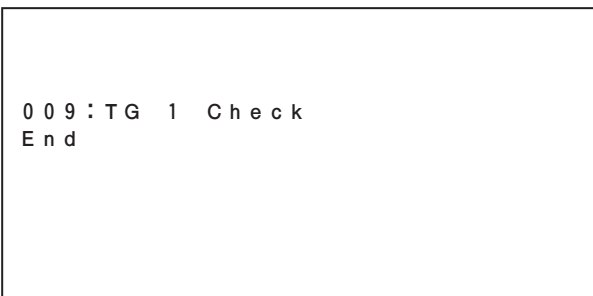
Displayed Message:



Selected screen



When a sound is being produced.



When the checking is finished.

Supplement:

Sound producing keyboard range is 32 notes from C2 to G4.
Number of sounds is 64.

Indications during Execution	Circuit Board	Location	Name in Circuit Diagram
TG1 Check --	DM	IC505	SWP51B MASTER
TG2 Check --	DM	IC506	SWP51B SLAVE

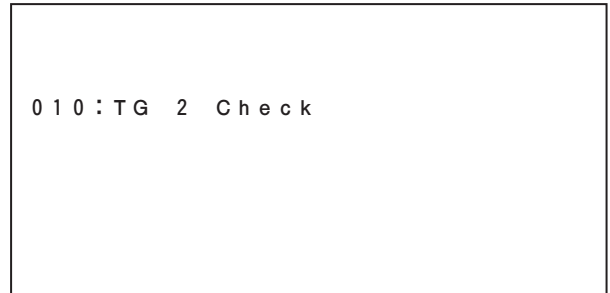
Test 10

Function: Sound check of the Tone Generator 2

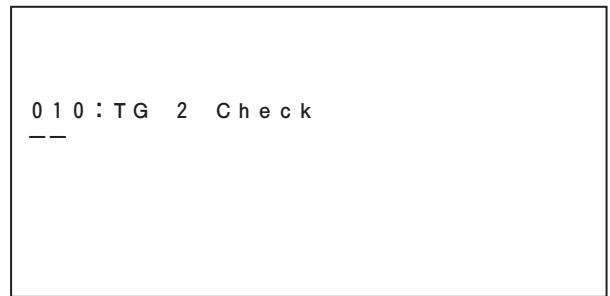
Description:

Sequentially outputs sounds starting from lower keys by switching the channel of the sound source at the SWP51B Slave side for checking sound generator and sound. Check that there is no abnormal sounds or noise.

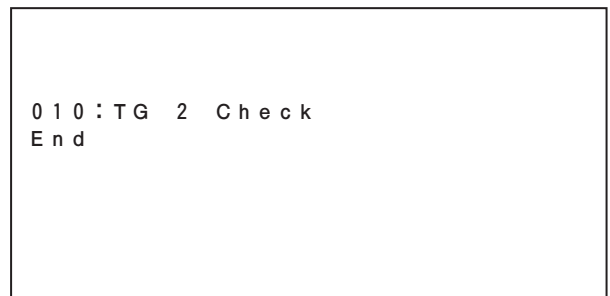
Displayed Message:



Selected screen



When a sound is being produced.



When the checking is finished.

Supplement:

Sound producing keyboard range is 32 notes from C2 to G4.
Number of sounds is 64.

Indications during Execution	Circuit Board	Location	Name in Circuit Diagram
TG1 Check --	DM	IC505	SWP51B MASTER
TG2 Check --	DM	IC506	SWP51B SLAVE

Test 11

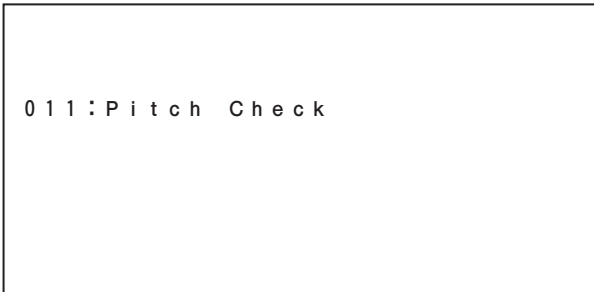
Function: Pitch check

Description:

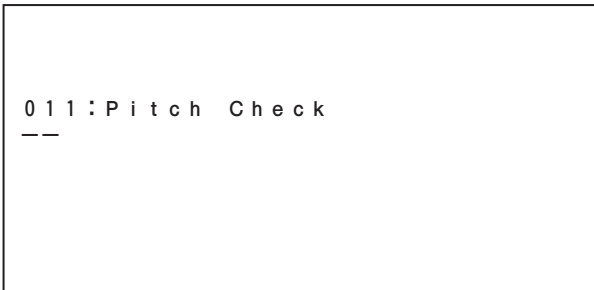
Set the [MASTER VOLUME] to the maximum level.
 Connect a frequency counter to the [PHONES] jack. (Either L or R)
 (Load should be 33 Ω. (30 Ω is acceptable as well: -0.6 dB))
 Confirm that the frequency counter shows "441.43 +/- 0.22 Hz".

- Amount of volume decay:
 Set the [MASTER VOLUME] to the minimum level.
 Connect a level meter (JIS-C curve) to the L/R of [PHONES] terminal.
 (Load should be 33 Ω. (30 Ω is acceptable as well: -0.6 dB))
 - PHONES L: -60.0 dBu or less
 - PHONES R: -60.0 dBu or less

Displayed Message:



Selected screen



When a sound is being produced.

Supplement:

Sound is stopped when the test item is quit.

Test 12

Function: Output Level R check

Description:

Connect a level meter (JIS-C curve) to each jack. ([PHONES] L, R, [LINE OUT MAIN] L/L+R, R, [AUX OUT/LOOP SEND] L/L+R, R, [TO SUB WOOFER R] L, R)

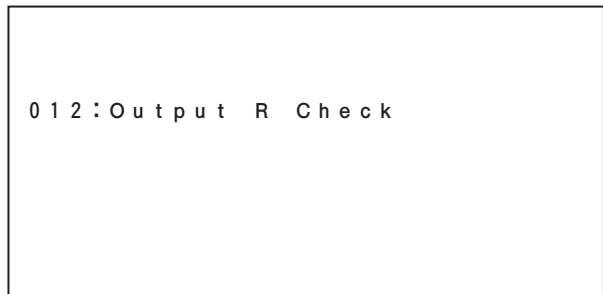
Set the [MASTER VOLUME] to the maximum level and check the output level of the R channel.

- [PHONES] L, R
 (33 Ω load (30 Ω is acceptable as well: -0.6 dB))
 - PHONES L: -55.0 dBu or less
 - PHONES R: +1.0±2 dBu
- [LINE OUT MAIN] L/L+R, R
 (10 k Ω load (2 monaural jacks used simultaneously))
 - LINE OUT MAIN L/L+R: -75.0 dBu or less
 - LINE OUT MAIN R: +9.5±2 dBu
- [AUX OUT/LOOP SEND] L/L+R, R
 (10 k Ω load (2 monaural jacks used simultaneously))
 - AUX OUT/LOOP SEND L/L+R: -75.0 dBu or less
 - AUX OUT/LOOP SEND R: +5.0±2 dBu
- [TO SUB WOOFER R] L, R
 (470 Ω load (L side: between 6P-3P, R side: between 5P-3P, GND: 3P))
 - TO SUB WOOFER R L: -65.0 dBu or less
 - TO SUB WOOFER R R: +5.5±2 dBu

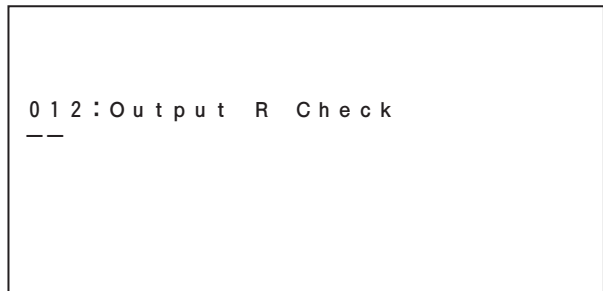
Disconnect the headphone and connect the optional speakers to the left and right speaker terminals.

Confirm that the sound comes out only right speaker.

Displayed Message:



Selected screen



When a sound is being produced.

Supplement:

Sound is stopped when the test item is quit.

Test 13

Function: Output Level L check

Description:

Connect a level meter (JIS-C curve) to each jack. ([PHONES] L, R, [LINE OUT MAIN] L/L+R, R, [AUX OUT/LOOP SEND] L/L+R, R, [TO SUB WOOFER R] L, R)

Set the [MASTER VOLUME] to the maximum level and check the output level of the L channel.

[PHONES] L, R

(33 Ω load (30 Ω is acceptable as well: -0.6 dB))

- PHONES L: +1.0±2 dBu
- PHONES R: -55.0 dBu or less

[LINE OUT MAIN] L/L+R, R

(10 k Ω load (2 monaural jacks used simultaneously))

- LINE OUT MAIN L/L+R: +9.5±2 dBu
- LINE OUT MAIN R: -75.0 dBu or less

[AUX OUT/LOOP SEND] L/L+R, R

(10 k Ω load (2 monaural jacks used simultaneously))

- AUX OUT/LOOP SEND L/L+R: +5.0±2 dBu
- AUX OUT/LOOP SEND R: -75.0 dBu or less

[TO SUB WOOFER R] L, R

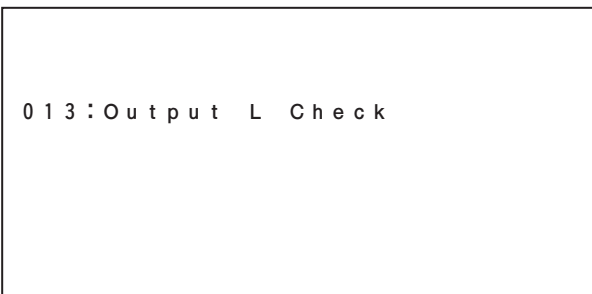
(470 Ω load (L side: between 6P-3P, R side: between 5P-3P, GND: 3P))

- TO SUB WOOFER R L: +5.5±2 dBu
- TO SUB WOOFER R R: -65.0 dBu or less

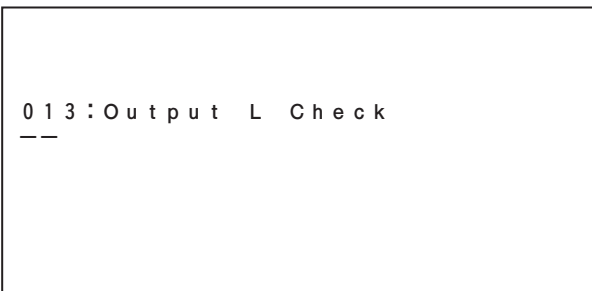
Disconnect the headphone and connect the optional speakers to the left and right speaker terminals.

Confirm that the sound comes out only left speaker.

Displayed Message:



Selected screen



When a sound is being produced.

Supplement:

Sound is stopped when the test item is quit.

Test 14

Function: Output Level Sub-1 check

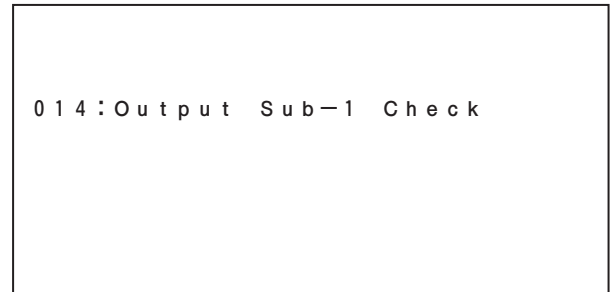
Description:

Set the [MASTER VOLUME] to the maximum level.

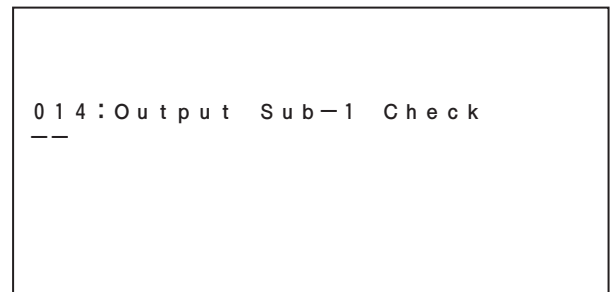
Connect a level meter (JIS-C curve) to the SUB1/ SUB2 of [LINE OUT] terminal. (Load should be 10 k Ω)

- LINE OUT SUB1: +3.0±2 dBu
- LINE OUT SUB2: -75.0 dBu or less

Displayed Message:



Selected screen



When a sound is being produced.

Supplement:

Sound is stopped when the test item is quit.

Test 15

Function: Output Level Sub-2 check

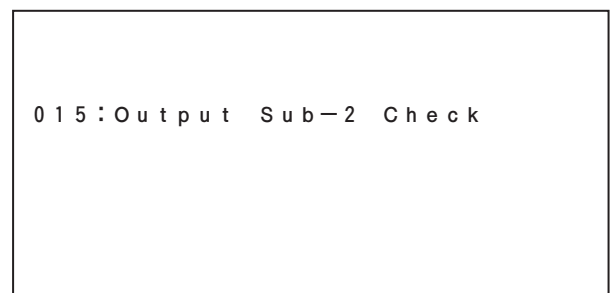
Description:

Set the [MASTER VOLUME] to the maximum level.

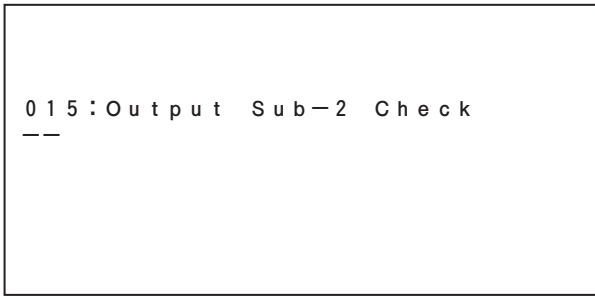
Connect a level meter (JIS-C curve) to the SUB1/ SUB2 of [LINE OUT] terminal. (Load should be 10 k Ω.)

- LINE OUT SUB1: -75.0 dBu or less
- LINE OUT SUB2: +3.0±2 dBu

Displayed Message:



Selected screen



When a sound is being produced.

Supplement:

Sound is stopped when the test item is quit.

Noise Level:

Set the [MASTER VOLUME] to the maximum level.
 Connect a level meter to the L/R of [PHONES] terminal.
 Load should be 33 Ω. (30 Ω is acceptable as well: -0.6 dB)
 L side: -80.0 dBu or less
 R side: -80.0 dBu or less

Set the [MASTER VOLUME] to the maximum level.
 Connect a level meter to the MAIN L/L+R, R of [LINE OUT] terminal.

(Use two monaural jacks simultaneously)

Load should be 10 k Ω.
 L side: -75.0 dBu or less
 R side: -75.0 dBu or less

Set the [MASTER VOLUME] to the maximum level.
 Connect a level meter to the [WOOFER R] terminal.
 (L side: between 6P-3P, R side: between 5P-3P, GND: 3P)
 Load should be 470 Ω.
 L side: -80.0 dBu or less
 R side: -80.0 dBu or less

Set the [MASTER VOLUME] to the maximum level.
 Connect a level meter to the [LINE OUT SUB1] terminal.
 Load should be 10 k Ω.
 SUB1 side: -80.0 dBu or less

Set the [MASTER VOLUME] to the maximum level.
 Connect a level meter to the [LINE OUT SUB2] terminal.
 Load should be 10 k Ω.
 SUB2 side: -80.0 dBu or less

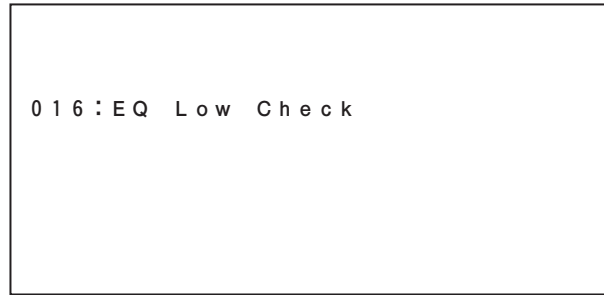
Test 16

Function: EQ (Low) frequency check

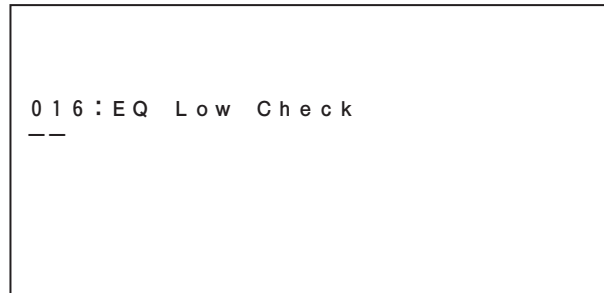
Description:

The sine wave of about 65.4 Hz (C1) is output from the [LINE OUT] jacks (MAIN L/L+R, MAIN, R, SUB1, SUB2).

Displayed Message:



Selected screen



When a sound is being produced.

Supplement:

Sound is stopped when the test item is quit.

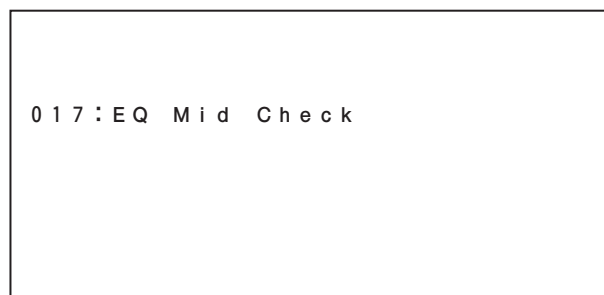
Test 17

Function: EQ (Mid) frequency check

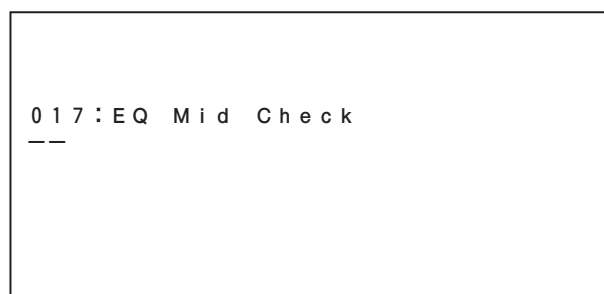
Description:

The sine wave of about 523 Hz (C4) is output from the [LINE OUT] jacks (MAIN L/L+R, MAIN, R, SUB1, SUB2).

Displayed Message:



Selected screen



When a sound is being produced.

Supplement:

Sound is stopped when the test item is quit.

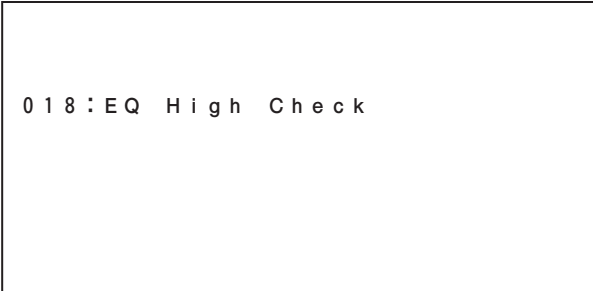
Test 18

Function: EQ (High) frequency check

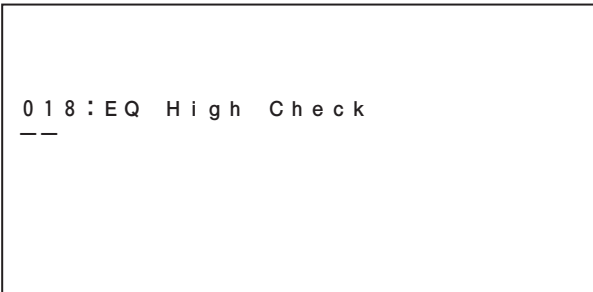
Description:

The sine wave of about 4,186 Hz (C7) is output from the [LINE OUT] jacks (MAIN L/L+R, MAIN, R, SUB1, SUB2).

Displayed Message:



Selected screen



When a sound is being produced.

Supplement:

Sound is stopped when the test item is quit.

Test 19

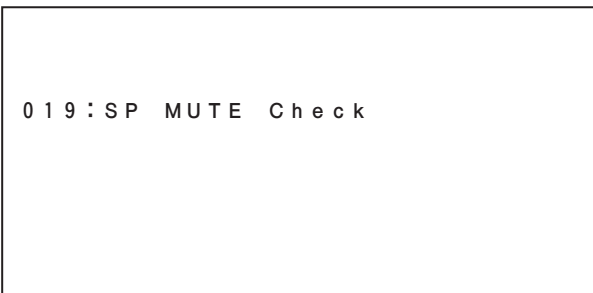
Function: SP MUTE check

Description:

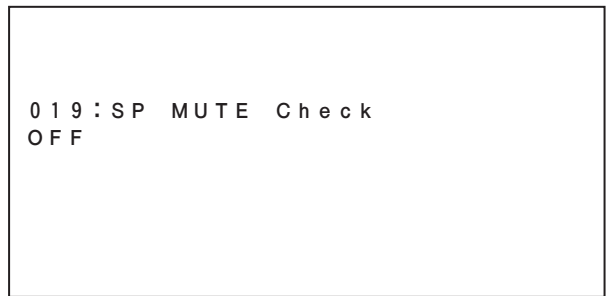
When the test is executed, the sine wave of about 1,046 Hz (C5) is output from the [LINE OUT] jacks (MAIN L/L+R, MAIN, R, SUB1, SUB2).

Confirm that the "ON" and "OFF" of SP MUTE can be toggled by pressing the TAB [<] or the TAB [>] button.

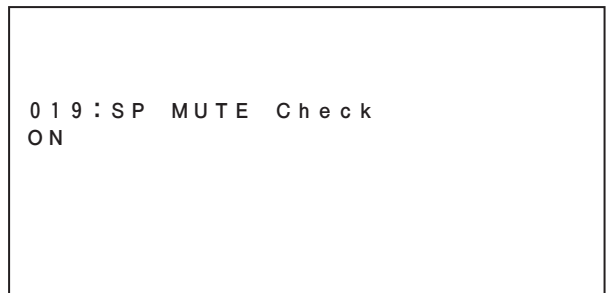
Displayed Message:



Selected screen



During MUTE OFF



During MUTE ON

Supplement:

SP MUTE (sound) shall not be controlled with connection/disconnection of headphones during this test.

Sound is stopped when the test item is quit.

Test 20

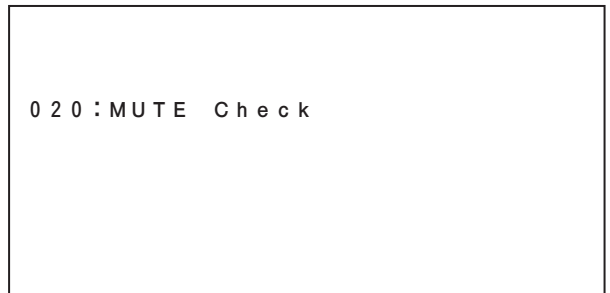
Function: MUTE check

Description:

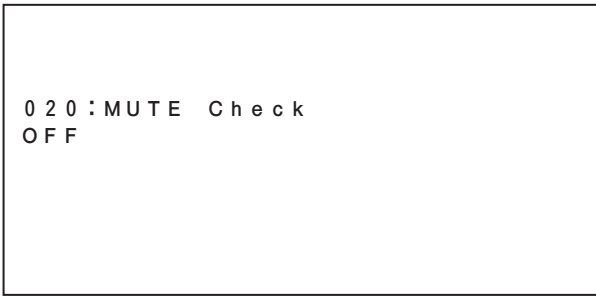
When the test is executed, the sine wave of about 1,046 Hz (C5) is output from the [LINE OUT] jacks (MAIN L/L+R, MAIN, R, SUB1, SUB2).

Confirm that the "ON" and "OFF" of MUTE can be toggled by pressing the TAB [<] or the TAB [>] button.

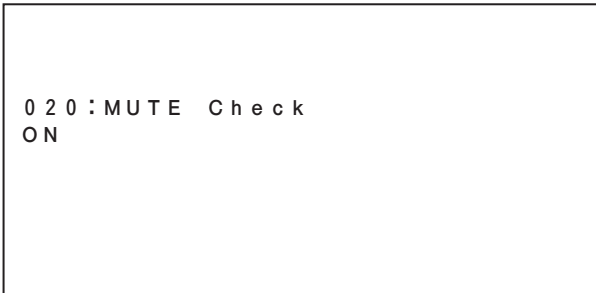
Displayed Message:



Selected screen



During MUTE OFF



During MUTE ON

Supplement:

MUTE (sound) shall not be controlled with connection/disconnection of headphones during this test. Sound is stopped when the test item is quit.

Test 21

Function: MIC L check

Description:

Check output sound with MIC L input. Check that there is no abnormal sounds or noise.

The [MASTER VOLUME] can be set to any level.

Set the [INPUT VOLUME] to the maximum level.

Set the [LINE IN/MIC TRIM] volume to the maximum level

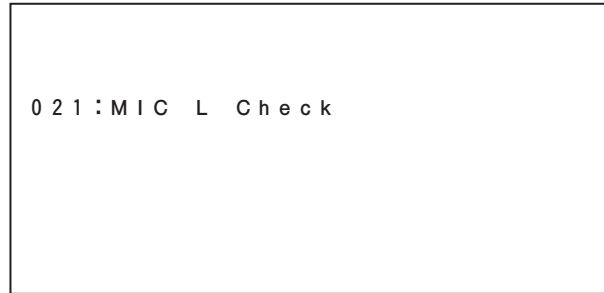
Connect a level meter (JIS-C curve) to the L/L+R of [AUX OUT/LOOP SEND] terminal. (Load should be 10 k Ω.)

Input signal of -45 dBu (1 kHz sine wave) from an oscillator to the L/L+R of [LINE IN/MIC] terminal and measure at output terminals.

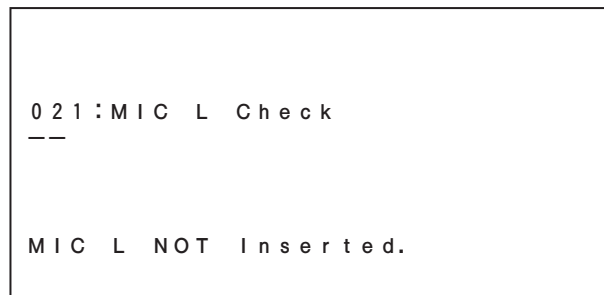
- AUX OUT/LOOP SEND L/L+R: +13.0±2 dBu
- Amount of TRIM volume decay:
Change the [LINE IN/MIC TRIM] volume to the minimum level with the other setups remained as above. (Leave the [INPUT VOLUME] at the maximum position.)
Measure output terminals.
 - AUX OUT/LOOP SEND L/L+R: -34.0±2 dBu
- Amount of volume decay:
Change the [INPUT VOLUME] to the minimum level with the other setups remained as above. (Leave the [LINE IN/MIC TRIM] volume at the minimum level.)
Measure output terminals.
 - AUX OUT/LOOP SEND L/L+R: -70.0 dBu or less

Check also if connection and disconnection of MIC is detected by inserting and removing MIC.

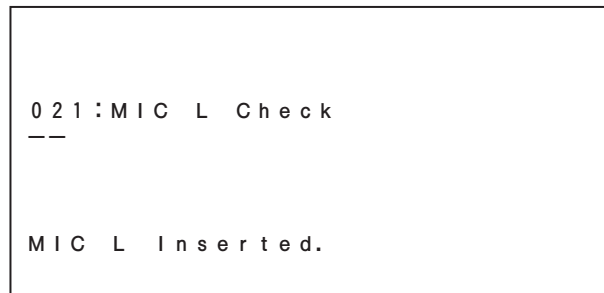
Displayed Message:



Selected screen



When MIC L is unconnected



When MIC L is connected

Supplement:

[SIGNAL] LED do not light up.

Test 22

Function: MIC R check

Description:

Check output sound with MIC R input. Check also that there is no abnormal sounds or noise.

The [MASTER VOLUME] can be set to any level.

Set the [INPUT VOLUME] to the maximum level.

Set the [LINE IN/MIC TRIM] VOLUME to the maximum level.

Connect a level meter (JIS-C curve) to the R of [AUX OUT/ LOOP SEND] terminal. (Load should be 10 k Ω.)

Input signal of -45 dBu (1 kHz sine wave) from an oscillator to the R of [LINE IN/MIC] terminal and measure at output terminals.

- AUX OUT/LOOP SEND R: +13.0±2 dBu

- Amount of TRIM volume decay:
Change the [LINE IN/MIC TRIM] volume to the minimum level with the other setups remained as above. (Leave the [INPUT VOLUME] at the maximum position.)
Measure output terminals.
 - AUX OUT/LOOP SEND R: -34.0 ± 2 dBu
- Amount of volume decay:
Change the [INPUT VOLUME] to the minimum level with the other setups remained as above. (Leave the [LINE IN/MIC TRIM] volume at the minimum level.)
Measure output terminals.
 - AUX OUT/LOOP SEND R: -70.0 dBu or less

Check also if connection and disconnection of MIC is detected by inserting and removing MIC.

Displayed Message:

```
0 2 2 : M I C   R   C h e c k
```

Selected screen

```
0 2 2 : M I C   R   C h e c k
--
M I C   R   N O T   I n s e r t e d .
```

When MIC R is unconnected

```
0 2 2 : M I C   R   C h e c k
--
M I C   R   I n s e r t e d .
```

When MIC R is connected

Supplement:

[SIGNAL] LED do not light up.

AUX IN/LOOP RETURN input level:

Set the [MASTER VOLUME] to the maximum level.
Set the [AUX IN/LOOP RETURN TRIM VOLUME] to the maximum level.

Connect a level meter to the MAIN L/L+R, R of [LINE OUT] terminal.

Load should be $10\text{ k } \Omega$.

Input signals from an oscillator to the L/L+R, R of [AUX IN/ LOOP RETURN] terminal.

Input Level: -20 dBu (1 kHz sine wave)

L side: $+2.0 \pm 2$ dBu

R side: $+2.0 \pm 2$ dBu

Amount of volume decay:

Change the [AUX IN/LOOP RETURN TRIM VOLUME] to the minimum level with the other setups remained as above.

L side: -75.0 dBu or less

R side: -75.0 dBu or less

Test 23

Function: Switch, LED Check

Description:

When a panel switch is being pressed, a sound is kept produced at a pitch corresponding to the switch (page 112). When the switch is released, the sound is stopped.

If there is an LED for the switch, the LED will light up.

The LED will be turned off when the next switch is pressed correctly.

In case of two-colored LED, both the two colors will light. Operate the [DATA ENTRY] dial following the indications on the LCD to check Dial Up and Dial Down. (The number should increase when turned clockwise and decrease when turned counterclockwise.)

Displayed Message:

```
0 2 3 : S W , L E D   C h e c k
```

Selected screen

```
0 2 3 : S W , L E D   C h e c k
P u s h   T E M P O   D O W N
```

Indicates a switch name.

```
0 2 3 : S W , L E D C h e c k
T E M P O D O W N O n
```

The specified switch is pressed.

```
0 2 3 : S W , L E D C h e c k
N G ( O : 0 6 5 A , X : 0 4 5 A )
```

A wrong switch is pressed.

(O: ID of the switch to be pressed,
X: ID of the switch which is actually pressed)

```
0 2 3 : S W , L E D C h e c k
O v e r T w o S W
```

Plural switches are pressed.

```
0 2 3 : S W , L E D C h e c k
E n d
```

Test completed

Supplement:

If an unspecified switch is pressed, a sound corresponding to the switch will be played.
Press the [START/STOP] switch to go back to the selection screen when the test is completed.
Press the [DEMO] switch to abort the test halfway and return to the item selection display. (The switch is effective only after the checking of the switch is completed)

Test 24

Function: All Panel LEDs On check

Description:

Turns on all the panel LEDs. (Two-colored LEDs will light in orange.)

Displayed Message:

```
0 2 4 : A l l P a n e l L E D O n C h e c k
```

All LED on check

```
0 2 4 : A l l P a n e l L E D O n C h e c k
--
```

During checking

Supplement:

There are two lighting areas and the areas will be switched as the TAB [<|/|>] key is pressed.
The LEDs will go off after exiting the test item.

Test 25

Function: Red LEDs On check

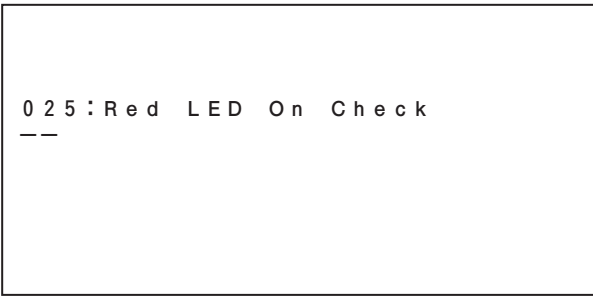
Description:

Turns on all the red panel LEDs. (Two-colored LEDs will light in red.)

Displayed Message:

```
0 2 5 : R e d L E D O n C h e c k
```

Selected screen



During checking

Supplement:

There are two lighting areas and the areas will be switched as the TAB [< / >] key is pressed.
The LEDs will go off after exiting the test item.

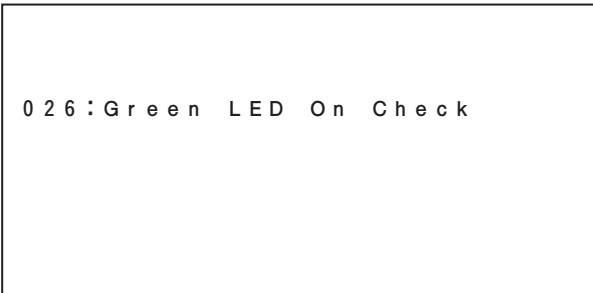
Test 26

Function: Green LEDs On check

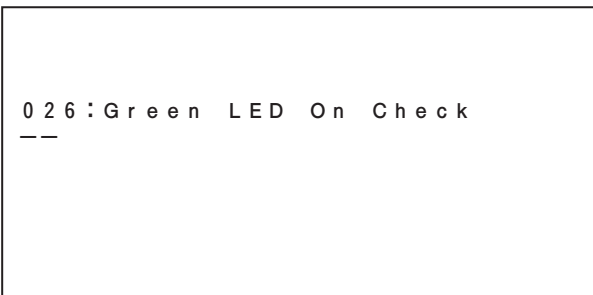
Description:

Turns on all the green panel LEDs. (Two-colored LEDs will light in green.)

Displayed Message:



Selected screen



During checking

Supplement:

There are two lighting areas and the areas will be switched as the TAB [< / >] key is pressed.
The LEDs will go off after exiting the test item.

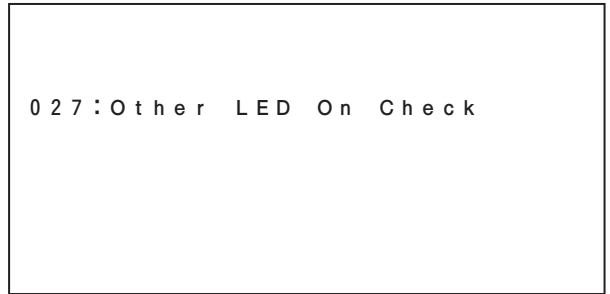
Test 27

Function: Other colors LEDs On check

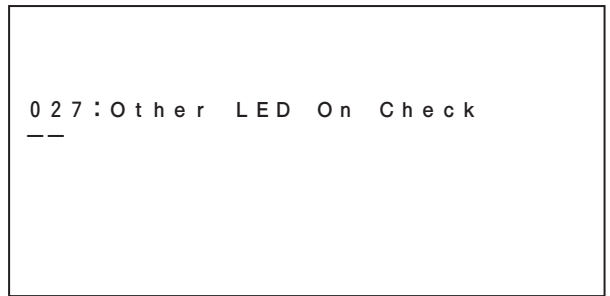
Description:

Turns on all the panel LEDs (orange and white) other than the red and green ones.

Displayed Message:



Selected screen



During checking

Supplement:

The LEDs will go off after exiting the test item.

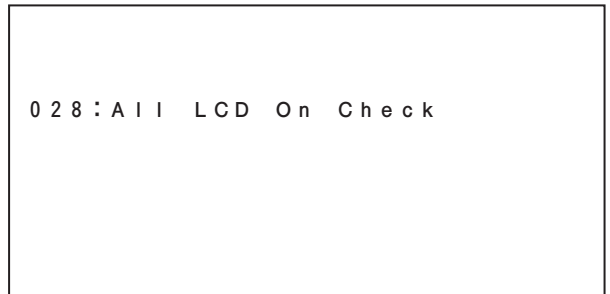
Test 28

Function: Whole LCD ON check

Description:

Lights up all the dots on the LCD.

Displayed Message:

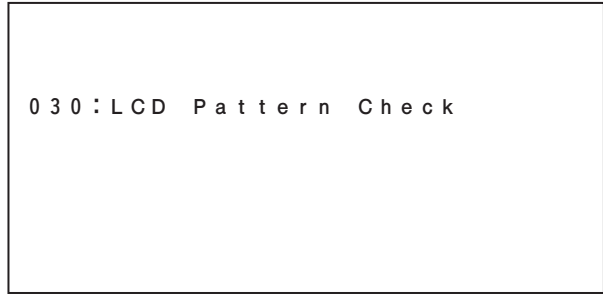


Selected screen



During checking

Displayed Message:



Selected screen

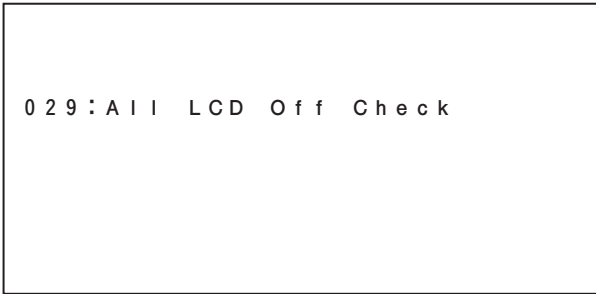
Test 29

Function: Whole LCD OFF check

Description:

Turns off all the dots on the LCD. (The whole screen will be white)

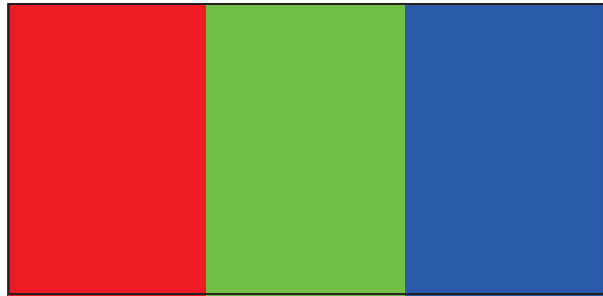
Displayed Message:



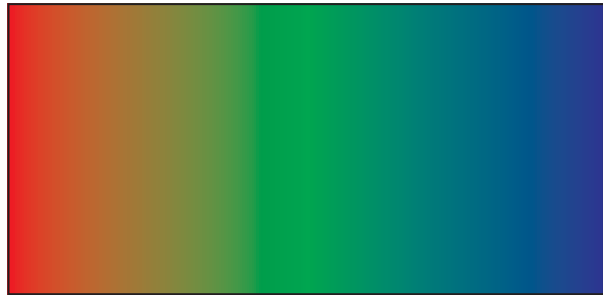
Selected screen



During checking



RGB pattern



Rainbow pattern



Flicker noise pattern

Test 30

Function: LCD pattern check

Description:

Displays color patterns for checking LCD picture quality. Switch the patterns RGB → rainbow → flicker noise check with the TAB [**<**]/[**>**] keys.

Test 31

Function: Pitch Bend Wheel check

Description:

Checks the pitch bend wheel. Center position of the wheel is detected after detecting MIN and MAX.

① "Pitch Bend Down":

Turn the wheel all the way toward you from the center position. (The sine wave C3 note sound will be produced when the wheel is at the minimum value, 0.)

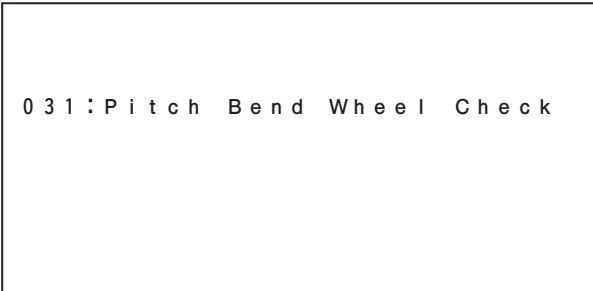
② "Pitch Bend Up":

Turn the wheel all the way away from you. (The sine wave G3 note sound will be produced when the wheel is at the maximum value, 127.)

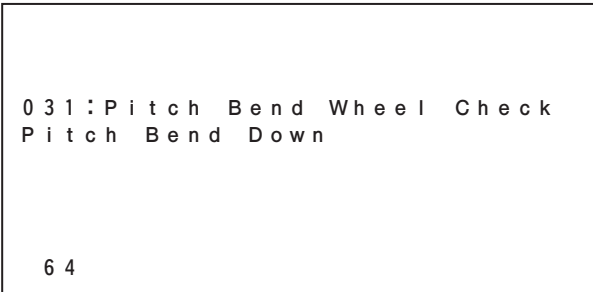
③ "Pitch Bend Center":

Release the wheel to set it back to the center position. (The sine wave C4 note sound will be produced when the wheel is at the center with the value of 64.)

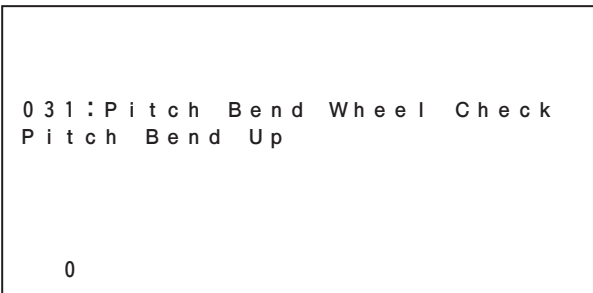
Displayed Message:



Selected screen



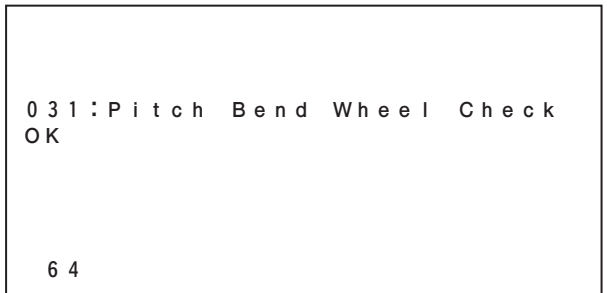
When the checking is started



Detection of the minimum value



Detection of the maximum value



In case of OK (When the center value is detected)

Test 32

Function: Modulation wheel check

Description:

Checks the modulation wheel. MAX and MIN are detected.

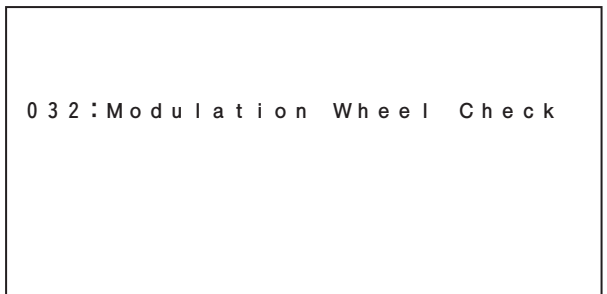
① "Modulation Up":

Turn the wheel all the way away from you. (The sine wave C3 note sound will be produced when the wheel is at the maximum value, 127.)

② "Modulation Down":

Turn the wheel all the way toward you. (The sine wave C4 note sound will be produced when the wheel is at the minimum value, 0.)

Displayed Message:



Selected screen

```

0 3 2 : M o d u l a t i o n   W h e e l   C h e c k
M o d u l a t i o n   U p

x x x
    
```

When the checking is started
(xxx: Indicates current value)

```

0 3 2 : M o d u l a t i o n   W h e e l   C h e c k
M o d u l a t i o n   D o w n

1 2 7
    
```

Detection of the maximum value

```

0 3 2 : M o d u l a t i o n   W h e e l   C h e c k
O K

0
    
```

Detection of the minimum value (In case of OK)

Test 33

Function: Slider check

Description:

Slide the 9 sliders one by one in the order of Max (255) to Min (0) and check that the operation is detected.

When checking a slider, current value will be shown.

Checking is executed in the order of [ASSIGN] → [S1] → [S2] → ... → [S8], and the result of each slider should be OK to proceed to the next checking.

Displayed Message:

```

0 3 3 : S l i d e r   C h e c k
    
```

Selected screen

```

0 3 3 : S l i d e r   C h e c k

[ A S S I G N ]   U p   ( --- )
    
```

When the checking is started.
(Starts with the [ASSIGN]. Indicates current value in parentheses ().)

```

0 3 3 : S l i d e r   C h e c k

[ A S S I G N ]   D o w n   ( 2 5 5 )
    
```

During checking
(After the maximum value is detected, the indication will change to "Down".)

```

0 3 3 : S l i d e r   C h e c k

[ A S S I G N ]   O K
    
```

During checking
(After the minimum value is detected, the indication will change to "OK".)

```

0 3 3 : S l i d e r   C h e c k

[   S 1   ]   U p   (   5 )
    
```

The indication changes to the next slider and the checking will be executed.

```

0 3 3 : S l i d e r   C h e c k

[   S 8   ]   O K
    
```

When the checking proceeds to the slider 8 and the result is "OK",



```
0 3 3 : S l i d e r   C h e c k
O K
```

the indication will change to "OK".

Supplement:

It is not until the device is moved after the checking is started when a value is loaded.

A current value will be indicated for a device until the result is judged as OK.

When the result of all the devices are OK, only "OK" will be shown on the screen.

Test 34

Function: Pedal 1 check

Description:

Detects Max/Min of the pedal 1.

Execute the test after connecting a foot pedal (FC7) to the [ASSIGNABLE FOOT PEDAL 1] terminal.

- ① "Pedal 1 Down":
Depress the pedal.
(The sine wave C3 note sound will be produced.)
- ② "Pedal 1 Up":
Release the pedal.
(The sine wave G3 note sound will be produced.)
- ③ "Pedal 1 Out":
Disconnect the pedal from the terminal.
(The sine wave C4 note sound will be produced.)

Displayed Message:

```
0 3 4 : P e d a l 1   C h e c k
```

Selected screen

```
0 3 4 : P e d a l 1   C h e c k
P e d a l 1   D o w n
```

When the checking is started

```
0 3 4 : P e d a l 1   C h e c k
P e d a l 1   U p
```

Detection of Min

```
0 3 4 : P e d a l 1   C h e c k
P e d a l 1   O u t
```

Detection of Max

```
0 3 4 : P e d a l 1   C h e c k
O K
```

In case of OK (Disconnection detection)

```
0 3 4 : P e d a l 1   C h e c k
N o   P e d a l
```

When unconnected (No foot pedal is connected)

Supplement:

Use an FC7 pedal for the checking.

Test 35

Function: Pedal 2 check

Description:

Detects Max/Min of the pedal 2.

Execute the test after connecting a foot pedal (FC7) to the [ASSIGNABLE FOOT PEDAL 2] terminal.

- ① "Pedal 2 Down":
Depress the pedal.
(The sine wave C3 note sound will be produced.)
- ② "Pedal 2 Up":
Release the pedal.
(The sine wave G3 note sound will be produced.)
- ③ "Pedal 2 Out":
Disconnect the pedal from the terminal.
(The sine wave C4 note sound will be produced.)

Displayed Message:

```
0 3 5 : P e d a l 2   C h e c k
```

Selected screen

```
0 3 5 : P e d a l 2   C h e c k
P e d a l 2   D o w n
```

When the checking is started

```
0 3 5 : P e d a l 2   C h e c k
P e d a l 2   U p
```

Detection of Min

```
0 3 5 : P e d a l 2   C h e c k
P e d a l 2   O u t
```

Detection of Max

```
0 3 5 : P e d a l 2   C h e c k
O K
```

In case of OK (Disconnection detection)

```
0 3 5 : P e d a l 2   C h e c k
N o   P e d a l
```

When unconnected (No foot pedal is connected)

Supplement:

Use an FC7 pedal for the checking.

Test 36

Function: Pedal 3 check

Description:

Detects Max/Min of the pedal 3.

Execute the test after connecting a foot pedal (FC7) to the [ASSIGNABLE FOOT PEDAL 3] terminal.

- ① "Pedal 3 Down":
Depress the pedal.
(The sine wave C3 note sound will be produced.)
- ② "Pedal 3 Up":
Release the pedal.
(The sine wave G3 note sound will be produced.)
- ③ "Pedal 3 Out":
Disconnect the pedal from the terminal.
(The sine wave C4 note sound will be produced.)

Displayed Message:

```
0 3 6 : P e d a l 3   C h e c k
```

Selected screen

```
0 3 6 : P e d a l 3   C h e c k
P e d a l 3   D o w n
```

When the checking is started

```
0 3 6 : P e d a l 3   C h e c k
P e d a l 3   U p
```

Detection of Min

```
0 3 6 : P e d a l 3   C h e c k
P e d a l 3   O u t
```

Detection of Max

```
0 3 6 : P e d a l 3   C h e c k
O K
```

In case of OK (Disconnection detection)

```
0 3 6 : P e d a l 3   C h e c k
N o   P e d a l
```

When unconnected (No foot pedal is connected)

Supplement:

Use an FC7 pedal for the checking.

Test 37

Function: MIDI check

Description:

Checks transmission/reception of signals with the [MIDI IN] and [MIDI OUT] terminals connected with a MIDI cable in a loop. (Start checking with the MIDI terminals connected with a MIDI cable in a loop.)

Connect [MIDI-A OUT] to [MIDI-A IN] and [MIDI-B OUT] to [MIDI-B IN] with MIDI cables. (The result will be NG if connected alternately.)

The test result of MIDI-A is OK and the sine wave C3 note sound will be produced.

The test result of MIDI-B is OK and the sine wave C4 note sound will be produced.

Displayed Message:

```
0 3 7 : M I D I   C h e c k
```

Selected screen

```
037:MIDI Check
MIDI-A  --
MIDI-B  --
```

When the checking is started

```
037:MIDI Check
MIDI-A  OK
MIDI-B  --
```

When the MIDI-A is OK and MIDI-B is unchecked.

```
037:MIDI Check
MIDI-A  NG
MIDI-B  OK
```

When the MIDI-A is NG and MIDI-B is OK.

```
037:MIDI Check
OK
```

When both the MIDI-A and B are OK.

```
037:MIDI Check
MIDI-A  NG
MIDI-B  NG
```

When both the MIDI-A and B are NG.

Supplement:

In case of no input one second after the output, the result is judged as NG.

Test 38

Function: Loop Send/Return check

Description:

Loop Send/Return function check using an audio cable. The sine wave A3 note signal will be outputted from [LINE OUT (MAIN)] when test is started. The sound output will switched from [LINE OUT (MAIN)] to [AUX OUT/LOOP SEND] terminals when an audio cable is inserted to [AUX OUT/LOOP SEND L/L+R] terminal. If connect [AUX OUT/LOOP SEND] to [AUX IN/LOOP RETURN] terminals in above setting, A3 note signal will output from [LINE OUT (MAIN)].

Displayed Message:

```
038:Loop Send/Return Check
```

Selected screen

```
038:Loop Send/Return Check
```

```
LOOP SEND NOT Inserted.
```

When the LOOP SEND jack is not connected.

```
038:Loop Send/Return Check
```

```
LOOP SEND Inserted.
```

When connection to the LOOP SEND jack is detected.

Supplement:

No detection of connection is conducted at the [AUX OUT/ LOOP SEND(R)] terminal.

Test 39

Function: Sub Out connection check

Description:

[LINE OUT SUB 1] and [LINE OUT SUB 2] function check using an audio cable.

The C3 note will be outputted when an audio cable is inserted to the [LINE OUT SUB] terminals, and C4 note will output when an audio cable is disconnected from the terminals.

Displayed Message:

```
0 3 9 : S u b   O u t   C h e c k
```

Selected screen

```
0 3 9 : S u b   O u t   C h e c k
N o   S u b 1
N o   S u b 2
```

An audio cable is not inserted to the terminals

```
0 3 9 : S u b   O u t   C h e c k
S u b 1   I n
N o   S u b 2
```

An audio cable is inserted to the SUB 1 terminal only.

```
0 3 9 : S u b   O u t   C h e c k
S u b 1   O K
S u b 2   I n
```

An audio cable is disconnected from SUB 1 terminal and inserted to the SUB 2 terminal.

```
0 3 9 : S u b   O u t   C h e c k
O K
```

An audio cable is disconnected both terminal of SUB 1 and SUB 2.

Supplement:

Checking can be started with either the SUB 1 or 2.

Test 40

Function: Video Out check (NTSC RGB)

Description:

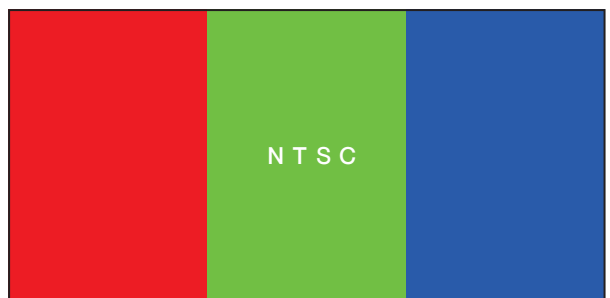
Conducts RGB (NTSC) test of the [VIDEO OUT] terminal. Connect a color CRT monitor that can display in NTSC and PAL systems to the [VIDEO OUT] terminal with a video cable (75Ω coaxial).

Check that RGB color bars (red, green and blue) are shown on the TV.

Displayed Message:

```
0 4 0 : V I D E O   O U T   N T S C   R G B
```

Selected screen



During checking

Test 41

Function: Video Out check (PAL RGB)

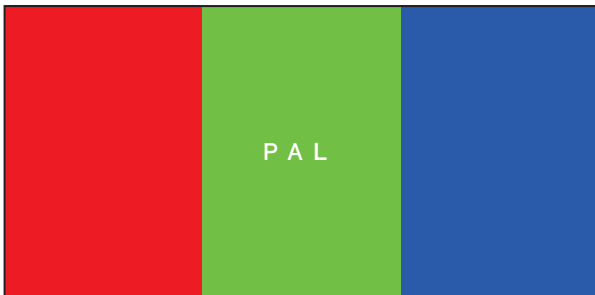
Description:

Conducts RGB (PAL) test of the [VIDEO OUT] terminal.
 Connect a color CRT monitor that can display in NTSC and PAL systems to the [VIDEO OUT] terminal with a video cable (75Ω coaxial).
 Check that RGB color bars (red, green and blue) are shown on the TV.

Displayed Message:



Selected screen



During checking

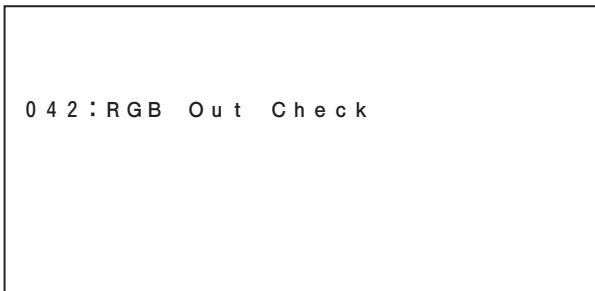
Test 42

Function: RGB Out check

Description:

Conducts RGB test of the [RGB OUT] terminal.
 Connect a color CRT monitor that can display in RGB to the [RGB OUT] terminal.
 Check that RGB color bars (red, green and blue) are shown on the RGB monitor.

Displayed Message:



Selected screen



During checking

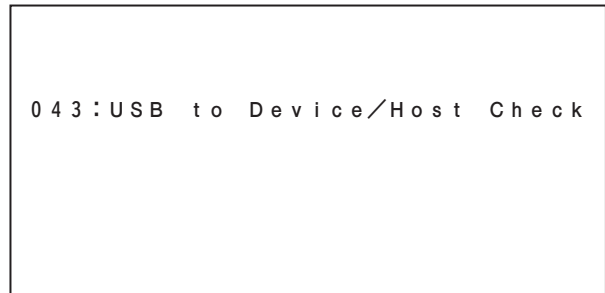
Test 43

Function: USB to Device/Host check

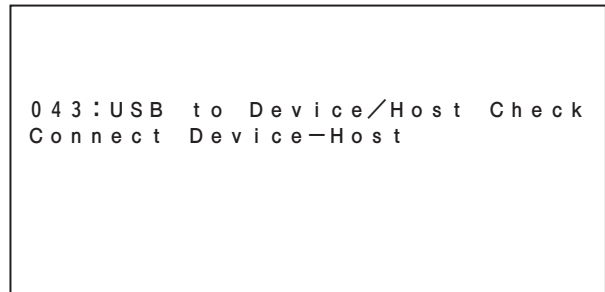
Description:

Conducts checking of the [USB TO DEVICE] terminal and [USB TO HOST] terminal simultaneously.
 Start checking without connecting a USB cable in a loop.
 The sine wave C4 note sound will be produced if the result of the two tests is OK.

Displayed Message:



Selected screen



* When the screen appears, connect the [USB TO DEVICE] terminal and [USB TO HOST] terminal with a USB cable.
 Checking [USB TO DEVICE] and [USB TO HOST]

```
0 4 3 : U S B   t o   D e v i c e / H o s t   C h e c k
C o n n e c t   U S B   S t o r a g e
```

* When the screen appears, connect the storage device to the [USB TO DEVICE] terminal on the front side.
Checking USB Storage

```
0 4 3 : U S B   t o   D e v i c e / H o s t   C h e c k
O K
```

In case of OK

```
0 4 3 : U S B   t o   D e v i c e / H o s t   C h e c k
N G
```

In case of NG

Supplement:

It is impossible to determine is the [USB TO DEVICE] terminal or [USB TO HOST] terminal is defective in case of NG.

The "**USB Storage Check**" can be used to check the [TO DEVICE] terminal. Combine the test to determine which terminal is defective.

Be sure to use a USB Storage whose operation is already checked. It does not matter if it is equipped with a disk or not.

Test 44

Function: USB Storage Device check

Description:

Connect a USB Storage device and check if it can be used. (Reads every 100 sectors from sector 0 and conducts sector read/write tests at ten points.)

Connect a storage device to the [USB TO DEVICE] terminal at the front side.

Displayed Message:

```
0 4 4 : U S B   S t o r a g e   D e v i c e   C h e c k
```

Selected screen

```
0 4 4 : U S B   S t o r a g e   D e v i c e   C h e c k
S t a r t
```

When the checking is started

```
0 4 4 : U S B   S t o r a g e   D e v i c e   C h e c k
O K
```

In case of OK

```
0 4 4 : U S B   S t o r a g e   D e v i c e   C h e c k
N G
```

In case of NG (Read/Write failure)

```
0 4 4 : U S B   S t o r a g e   D e v i c e   C h e c k
N O   D I S K
```

No media

```
044:USB Storage Device Check
UNFORMAT DISK
```

Media unformatted

```
044:USB Storage Device Check
PROTECT DISK
```

Media protected

Test 45

Function: LAN check

Description:

Conducts signal communication checking with the [LAN] terminal of the Tyros3 and a router for checking connected with a LAN cable. (Starts checking with the instrument connected with the LAN cable.)

It will take about 20 seconds for the check.

Displayed Message:

```
045:LAN Check
```

Selected screen

```
045:LAN Check
OK
```

In case of OK

```
045:LAN Check
NG
```

In case of NG

Supplement:

Use a router, which has the following specifications, in initial configuration.

- Equipped with DHCP server function
- Default IP address is 192.168.xxx.xxx

Do not connect an equipment other than the instrument to be checked to the router.

Test 46

Function: DGA (HDD) check

Description:

Checks if the DGA SDRAM (DM: IC204) and HDD are Read/Write enabled. (Sector Read/Write checking is conducted using the last 2 sectors of HDD after checking the SDRAM connection)

Displayed Message:

```
046:DGA (HDD) Check
```

Selected screen

```
046:DGA (HDD) Check
OK
```

In case of OK


```
0 4 6 : D G A ( H D D )   C h e c k
N G   ( D G A   S D R A M )
```

In case of NG (SDRAM connection error)

```
0 4 6 : D G A ( H D D )   C h e c k
N G   ( H D D - C P U )
```

In case of NG (DMA transmission error between HDD and CPU)

```
0 4 6 : D G A ( H D D )   C h e c k
N G   ( H D D   C O N N E C T )
```

In case of NG (HDD connection error)

```
0 4 6 : D G A ( H D D )   C h e c k
N G   ( D G A   I R Q 0 )
```

In case of NG (IRQ0 line connection error)

```
0 4 6 : D G A ( H D D )   C h e c k
N G   ( H D D   R E A D )
```

In case of NG (HDD Read error)

```
0 4 6 : D G A ( H D D )   C h e c k
N G   ( D G A   I R Q 4 )
```

In case of NG (IRQ4 line connection error)

```
0 4 6 : D G A ( H D D )   C h e c k
N G   ( H D D   W R I T E )
```

In case of NG (HDD Write error)

```
0 4 6 : D G A ( H D D )   C h e c k
N G   ( D G A   I R Q 5 )
```

In case of NG (IRQ5 line connection error)

```
0 4 6 : D G A ( H D D )   C h e c k
N G   ( H D D - D G A )
```

In case of NG (DMA transmission error between HDD and DGA)

Test 47

Function: DGA (TG) check

Description:

Checks connections of MEL connection between the DGA (DM: IC203) and SWP50 (DM: IC205).

Connect headphones to the [PHONES] terminal and switch between the LINE-A (input to the MEL4 of SWP50) and LINE-B (input to the MEL5 of SWP50) with the

TAB [◀]/[▶] keys.

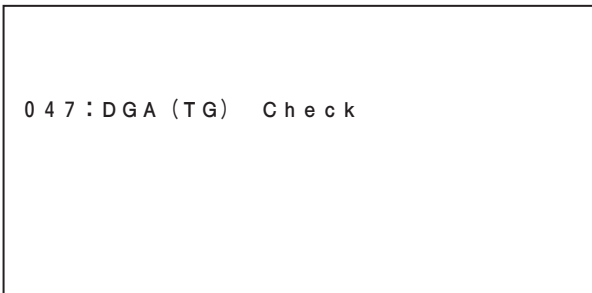
<LINE-A>

The sine wave A3 note sound (about 441.4 Hz) is produced with PAN at center.

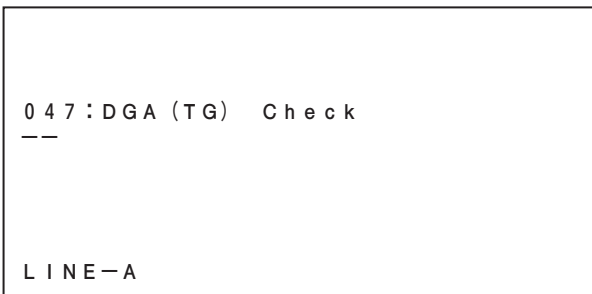
<LINE-B>

The sine wave about 1378 Hz is produced with PAN at R (repetition of sound production for 3 seconds and no sound for 0.5 second).

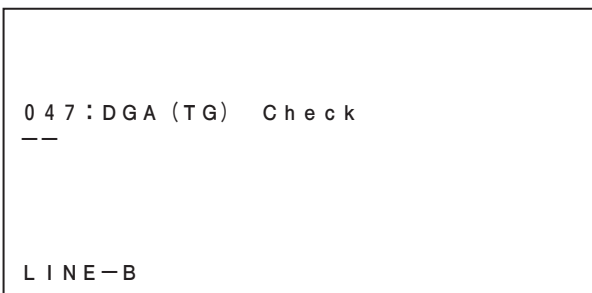
Displayed Message:



Selected screen



Checking LINE-A



Checking LINE-B

Supplement:

You may feel that TAB switches does not respond well when you depress, because, the unit can not respond during a sound is outputted from LINE-B (about 3 second period).

Sound is stopped when the test item is quit.

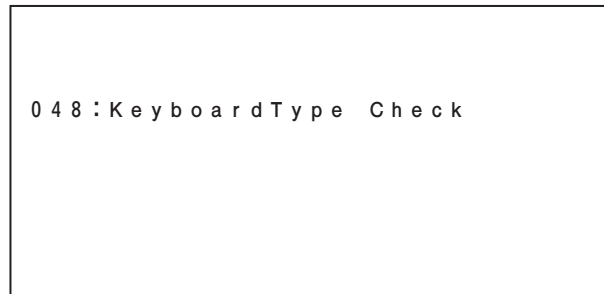
Test 48

Function: Keyboard Type check

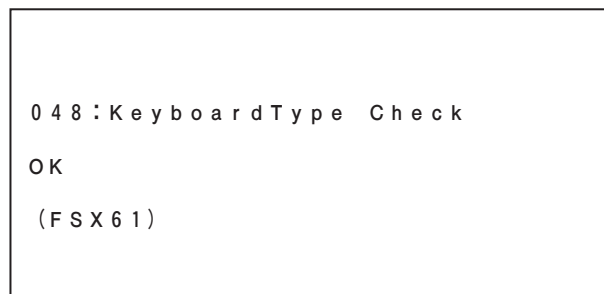
Description:

Judges connected keyboard type and indicated keyboard name.

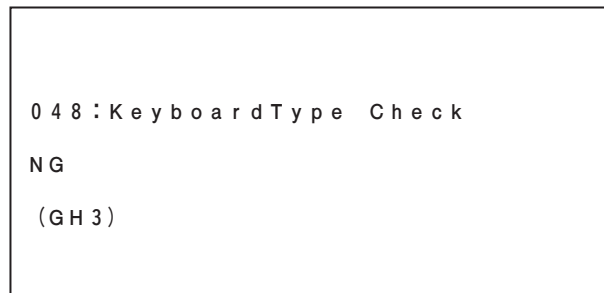
Displayed Message:



Selected screen



In case of OK



In case of NG

Supplement:

The keyboard name will be indicated in case of NG as well.

Test 49

Function: Touch check

Description:

Press the C3 key and press that until after touch will be activated.

Indicates initial touch (velocity)/after touch value of 0 to 127 decimally on the LCD.

Result will be OK if MAX (sine wave C3 note sound is produced)

→ MIN_(sine wave C4 note sound is produced) are detected.

Displayed Message:

```
0 4 9 : T o u c h   C h e c k
```

Selected screen

```
0 4 9 : T o u c h   C h e c k
T o u c h   S t a r t

V e l :   0
A f t :   0
```

When the checking is started

```
0 4 9 : T o u c h   C h e c k
O K

V e l : 7 7
A f t : 1 2 7
```

Upper: Velocity value

```
0 4 9 : T o u c h   C h e c k
O K

V e l : 7 7
A f t : 0
```

Lower: After touch value

When the maximum value of after touch is detected
In case of OK (When the minimum value of after touch is detected)

Test 50

Function: Full check of ROM
(This is a test for factory inspection)

Description:

Conducts read test (checksum inspection) on Program area and Data area.

It will take about 35 seconds for the check.

Displayed Message:

```
0 5 0 : R O M   C h e c k 2
```

Selected screen

```
0 5 0 : R O M   C h e c k 2
O K
```

In case of OK

```
0 5 0 : R O M   C h e c k 2
M A I N   P R O G   R O M   H / L   N G
M A I N   D A T A   R O M           N G
S U B   P R O G   R O M           N G
```

In case of NG (Example)

Supplement:

In case of NG, the name of the ROM of which NG is detected will be shown.

"No Card" will be shown if SUB PROG is not detected.

Error Indications	Circuit Board	Location	Name in Circuit Diagram
MAIN PROG ROM H/L NG	DM	IC10	MAIN PROG-L 256 M FLASH
MAIN PROG WR NG		IC11	MAIN PROG-H 256 M FLASH
MAIN DATA ROM NG	DM	IC14	DATA ROM 64 M
SUB PROG ROM NG	DM	IC514	SUB BOOT ROM 8 M
SUB PROG ROM No Card			

Test 51

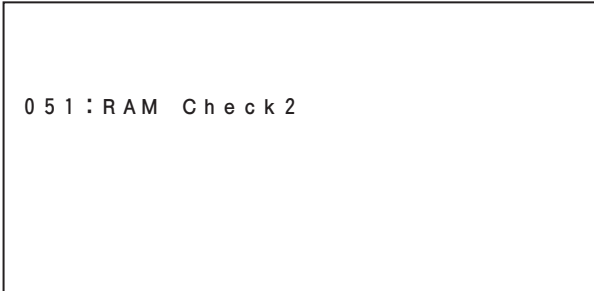
Function: Full check of RAM

(This is a test for factory inspection)

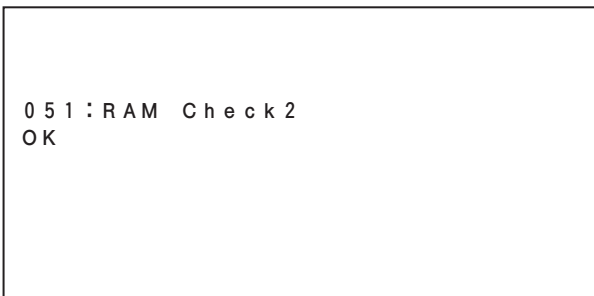
Description:

Executes Read/Write test (connection check) of RAM.

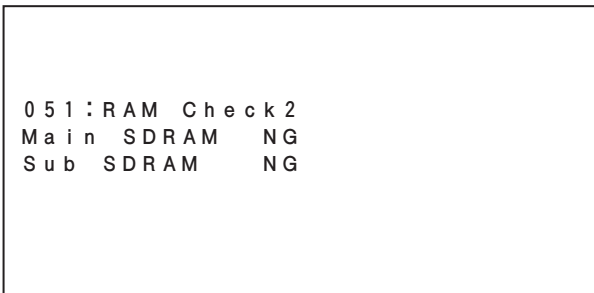
Displayed Message:



Selected screen



In case of OK



In case of NG

Supplement:

Location of NG will be shown in case of NG.

If sound board is not recognized, **"No Card"** will be shown for SUB SDRAM.

Error Indications	Circuit Board	Location	Name in Circuit Diagram
Main SDRAM NG	DM	IC12	SDRAM 256 M
		IC13	SDRAM 256 M
Sub SDRAM NG	DM	IC513	MAIN RAM 128 M SDRAM
Sub SDRAM No Card			

Test 52

Function: Full check of backup ROM

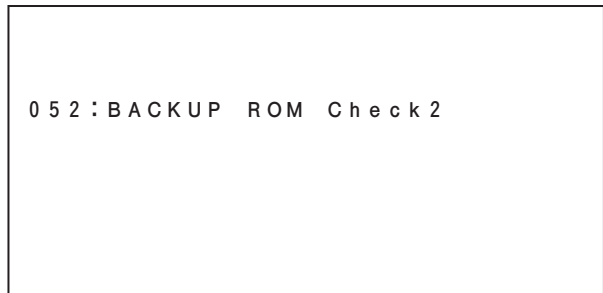
(This is a test for factory inspection)

Description:

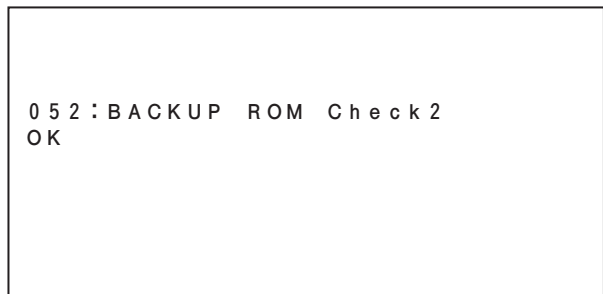
Executes Read/Write test of the entire blocks of Backup Flash ROM.

It will take about 4 minutes for the check.

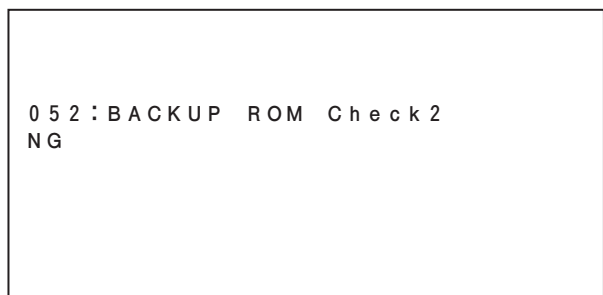
Displayed Message:



Selected screen



In case of OK



In case of NG

Supplement:

The check cannot be aborted until OK/NG result is indicated.

Original data will be written back after the test is executed.

Do not turn off the power during checking or the data will be lost.

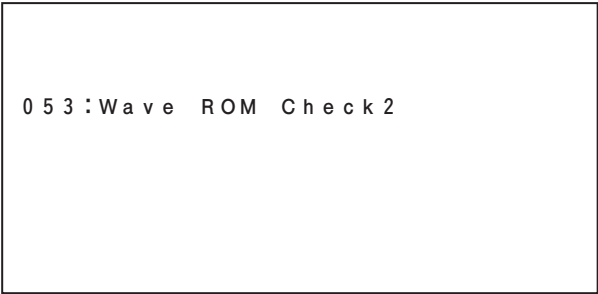
Error Indications	Circuit Board	Location	Name in Circuit Diagram
NG	DM	IC15	BACKUP 64 M FLASH

Test 53

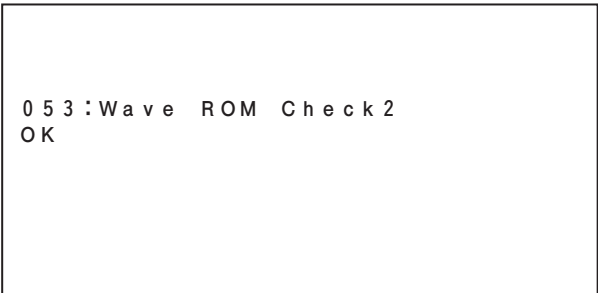
Function: Full check of Wave ROM
(This is a test for factory inspection)

Description:
Executes Read test (full address checksum test) of Wave ROM.
It will take about 2 minutes and 50 seconds for the check.

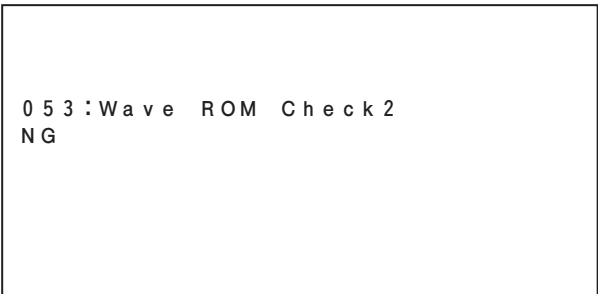
Displayed Message:



Selected screen



In case of OK



In case of NG

Applicable to serial number up to B00 01470, E00 02830, U00 01285 and ET00 01125

Error Indications	Circuit Board	Location	Name in Circuit Diagram
NG	DM	IC800	WAVE ROM L1 512 M MASK
		IC801	WAVE ROM L2 512 M MASK
		IC802	WAVE ROM H1 512 M MASK
		IC803	WAVE ROM H2 512 M MASK

Applicable to serial number from B00 01471, E00 02831, U00 01286 and ET00 01126

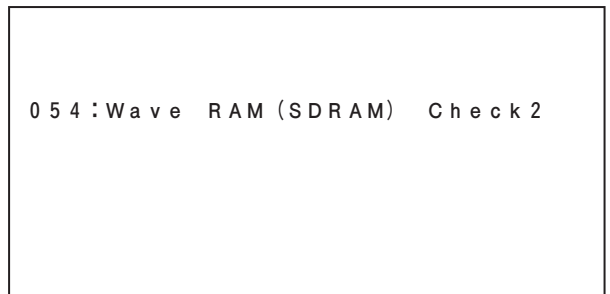
Error Indications	Circuit Board	Location	Name in Circuit Diagram
NG	DM	IC804	WAVE ROM L1 512 M MASK
		IC805	WAVE ROM L2 512 M MASK
		IC806	WAVE ROM H1 512 M MASK
		IC807	WAVE ROM H2 512 M MASK

Test 54

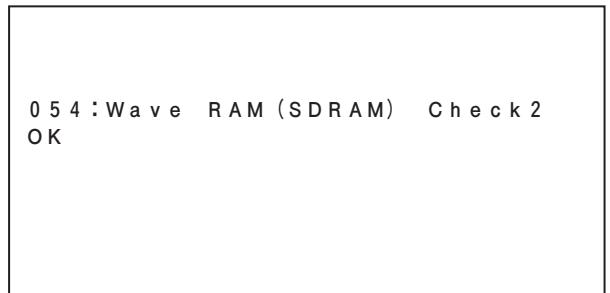
Function: Full check of Wave RAM (SDRAM)
(This is a test for factory inspection)

Description:
Executes full address checksum test of SDRAM for wave.
It will take about 6 seconds for the check.

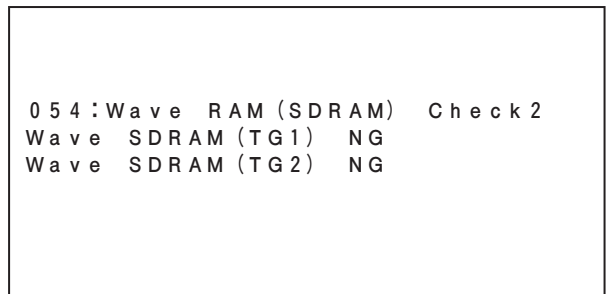
Displayed Message:



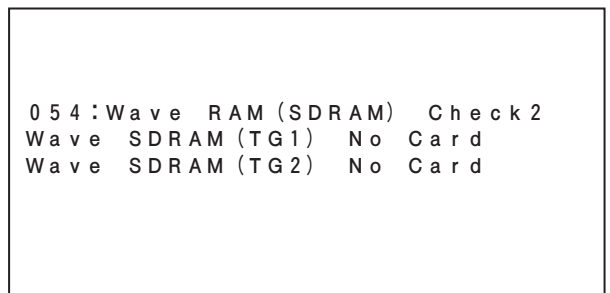
Selected screen



In case of OK



In case of NG



In case of NG (In case no sound board is recognized)

Supplement:

Check from TG1 → SWP51B Master (DM: IC505), TG2 → SWP51B Slave (DM: IC506).

Error Indications	Circuit Board	Location	Name in Circuit Diagram
Wave SDRAM(TG1) NG	DM	IC511 IC512	SAMPLING RAM-L 16 M SDRAM SAMPLING RAM-H 16 M SDRAM
Wave SDRAM(TG2) NG			
Wave SDRAM(TG1) No Card			
Wave SDRAM(TG2) No Card			

```

0 5 5 : W a v e   R A M   ( D I M M )   C h e c k 2
N G   ( D I M M   H :   0 M B , L :   0 M B )
W a v e   D I M M   ( T G 1 )   N o   C a r d
W a v e   D I M M   ( T G 2 )   N o   C a r d
    
```

In case of NG (In case no sound board is recognized)

Test 55

Function: Full check of Wave RAM (DIMM)
(This is a test for factory inspection)

Description:

Executes full address checksum test of DIMM for wave.
Indicates DIMM size as well.

Displayed Message:

```

0 5 5 : W a v e   R A M   ( D I M M )   C h e c k 2
    
```

Selected screen

```

0 5 5 : W a v e   R A M   ( D I M M )   C h e c k 2
O K   ( D I M M   H :   6 4 M B , L :   6 4 M B )
    
```

In case of OK (Indicates DIMM size in MB)

```

0 5 5 : W a v e   R A M   ( D I M M )   C h e c k 2
N G   ( D I M M   H :   0 M B , L :   0 M B )
W a v e   D I M M   ( T G 1 )   N G
W a v e   D I M M   ( T G 2 )   N G
    
```

In case of NG (Indicates DIMM size in MB)

Supplement:

Check from TG1 → SWP51B Master (DM: IC505), TG2 → SWP51B Slave (DM: IC506).

OK will be shown if DIMM connection is confirmed. Visually check DIMM size.

Specification check requires checking with DIMMs of maximum size, 512 MB, for both H/L.

Test 56

Function: Full check of Effect RAM
(This is a test for factory inspection)

Description:

Full address checksum inspection of EffectRAM
It will take about 18 seconds for the check.

Displayed Message:

```

0 5 6 : E f f e c t   R A M   C h e c k 2
    
```

Selected screen

```

0 5 6 : E f f e c t   R A M   C h e c k 2
O K
    
```

In case of OK

```
0 5 6 : E f f e c t   R A M   C h e c k 2
T G 1   N G
T G 2   N G
```

In case of NG

Supplement:

TG1 indicates Effect RAM of SWP51B Master (DM: IC505) and TG2 indicates Effect RAM of SWP51B Slave (DM: IC506).

Error Indications	Circuit Board	Location	Name in Circuit Diagram
TG1 NG	DM	IC508	WORK RAM 64 M SDRAM
TG2 NG	DM	IC509	WORK RAM 64 M SDRAM

Test 57 to 62

Factory Inspection only.

Test 63

Function: Factory Set

Description:

Restores the Tyros 3 to the factory initial setup.
(Sets the initial data to the Flash ROM.)

Displayed Message:

```
0 6 3 : F a c t o r y   S e t
```

Selected screen

```
0 6 3 : F a c t o r y   S e t
O K
```

During execution

Supplement:

In this stage, the flag for initialization is raised only and initialization will be executed when the power is turned on next time.

⚠ Caution

Don't turn off the power until the main screen is indicated after executing the **"Factory Set"**.

Test 64

Function: Exiting test mode

Description:

Quits the test mode and restarts. (Restarting should be conducted automatically. Check if the restarting is conducted.)

Displayed Message:

```
0 6 4 : T e s t   E x i t
```

Selected screen

Supplement:

⚠ Caution

Don't turn off the power until the main screen is indicated after executing the **"Exiting test mode"**.

■ INITIAL SETTING

Setting at the time of factory shipping.

- MASTER VOLUME: MIN
- INPUT VOLUME: MIN
- MODURATION WHEEL: MIN (toward you)
- LINE IN/MIC TRIM VOLUME: MAX
- AUX IN/LOOP RETURN TRIM VOLUME: MIN
- SLIDER VOLUME: MAX (top side)

• Switch Test Sequence

Turn	SW Name / Display	Note Number	Turn	SW Name / Display	Note Number	Turn	SW Name / Display	Note Number
1	TYPE SELECT	C2	57	MAIN B	G2	113	HARMONY ECHO	D3
2	MIC SETTING	C#2	58	MAIN C	G#2	114	INITIAL TOUCH	D#3
3	SONG I	D2	59	MAIN D	A2	115	SUSTAIN	E3
4	SONG II	D#2	60	BREAK	A#2	116	MONO	F3
5	SP1	E2	61	ENDING/rit. I	B2	117	DSP	F#3
6	SP2	F2	62	ENDING/rit. II	C3	118	DSP VARIATION	G3
7	REC	F#2	63	ENDING/rit. III	C#3	119	INTERNET	G#3
8	STOP	G2	64	SYNC STOP	D3	120	PIANO	A3
9	PLAY/PAUSE	G#2	65	SYNC START	D#3	121	E.PIANO	A#3
10	REW	A2	66	START/STOP	E3	122	ORGAN	B3
11	FF	A#2	67	BALANCE	F3	123	STRINGS	C4
12	DEMO	B2	68	UPPER OCTAVE –	F#3	124	CHOIR	C#4
13	VOCAL HARMONY	C3	69	UPPER OCTAVE +	G3	125	BRASS	D4
14	EFFECT	C#3	70	SA1	G#3	126	TRUMPET	D#4
15	TALK	D3	71	SA2	A3	127	SAXOPHONE	E4
16	SONG III	D#3	72	A	A#3	128	FLUTE/CLARINET	F4
17	SONG IV	E3	73	B	B3	129	MUSIC FINDER	F#4
18	SP3	F3	74	C	C4	130	GUITAR	G4
19	SP4	F#3	75	D	C#4	131	BASS	G#4
20	LOOP	G3	76	E	D4	132	PERC./DRUM KIT	A4
21	METRONOME	G#3	77	DIRECT ACCESS	D#4	133	ACCORDION	A#4
22	LYRICS/TEXT	A3	78	TAB <	E4	134	PAD	B4
23	SCORE	A#3	79	TAB >	F4	135	SYNTH	C5
24	POP & ROCK	B3	80	F	F#4	136	ORGAN FLUTES	C#5
25	BALLAD	C4	81	G	G4	137	EXPANSION	D5
26	DANCE	C#4	82	H	G#4	138	USER DRIVE	D#5
27	SWING & JAZZ	D4	83	I	A4	139	REGIST BANK –	E5
28	R & B	D#4	84	J	A#4	140	REGIST BANK +	F5
29	COUNTRY	E4	85	EXIT	B4	141	FREEZE	F#5
30	LATIN	F4	86	1-U	C5	142	MEMORY	G5
31	BALLROOM	F#4	87	2-U	C#5	143	OTS 1	G#5
32	MOVIE & SHOW	G4	88	3-U	D5	144	OTS 2	A5
33	ENTERTAINER	G#4	89	4-U	D#5	145	OTS 3	A#5
34	WORLD	A4	90	5-U	E5	146	OTS 4	B5
35	FILE ACCESS	A#4	91	6-U	F5	147	PART SELECT LEFT	C6
36	TRANSPOSE –	B4	92	7-U	F#5	148	PART SELECT RIGHT1	C2
37	TRANSPOSE +	C5	93	8-U	G5	149	PART SELECT RIGHT2	C#2
38	MIXING CONSOLE	C#5	94	1-L	G#5	150	PART SELECT RIGHT3	D2
39	FADE IN/OUT	D5	95	2-L	A5	151	REGIST. MEMORY 1	D#2
40	ACMP	D#5	96	3-L	A#5	152	REGIST. MEMORY 2	E2
41	OTS LINK	E5	97	4-L	B5	153	REGIST. MEMORY 3	F2
42	AUTO FILL IN	F5	98	5-L	C6	154	REGIST. MEMORY 4	F#2
43	TAP TEMPO	F#5	99	6-L	C2	155	REGIST. MEMORY 5	G2
44	TEMPO –	G5	100	7-L	C#2	156	REGIST. MEMORY 6	G#2
45	TEMPO +	G#5	101	8-L	D2	157	REGIST. MEMORY 7	A2
46	M.PAD SELECT	A5	102	ENTER	D#2	158	REGIST. MEMORY 8	A#2
47	M.PAD 1	A#5	103	FUNCTION	E2	159	LEFT HOLD	B2
48	M.PAD 2	B5	104	VOICE CREATOR	F2	160	PART ON/OFF LEFT	C3
49	M.PAD 3	C6	105	DIGITAL RECORDING	F#2	161	PART ON/OFF RIGHT1	C#3
50	M.PAD 4	C2	106	REC	G2	162	PART ON/OFF RIGHT2	D3
51	M.PAD STOP	C#2	107	STOP	G#2	163	PART ON/OFF RIGHT3	D#3
52	CHANNEL ON/OFF	D2	108	PLAY/PAUSE	A2			
53	INTRO I	D#2	109	PREV	A#2			
54	INTRO II	E2	110	NEXT	B2			
55	INTRO III	F2	111	SELECT	C3			
56	MAIN A	F#2	112	SETTING	C#3			

■ FORMATTING HDD

1. While holding down the [F] button and [J] button, turn on the power switch.
2. The device information indication mode will be started and the following screen will be shown.

```

=====
                        Device Information
=====

[ A ] : USB Storage

[ B ] : DIMM

[ C ] : Internal HDD

Press [EXIT] to quit.

```

3. Press the [C] button to go to the internal HDD information indication screen. If unformatted, “UNFORMAT DISK” will be shown. If the HDD is formatted, the screen in procedure 5 will be shown.

```

=====
                        IDE HDD Information
=====

UNFORMAT DISK

Press [DEMO] to format.
Press [EXIT] to quit.

```

4. Press the [DEMO] button to execute formatting. “Formatting ...” will be indicated during formatting procedure.
5. Information of the internal HDD will be shown when the formatting is completed. The formatting is executed normally if “TYROS3_HD” is shown in the “Volume Name” field. (If an error occurs, only error message will be indicated. Refer to the error message list at the end of this section.)

```

=====
                        IDE HDD Information
=====

Vender ID      : Not exist
Product ID     : ST980815A
Revision       : 3.AL
Capacity       : 74.42[GB]
Serial ID      : Exist
Volume Name    : TYROS3_HD

R/W test      :

Press [START/STOP] to test.
Press [DEMO] to format.
Press [EXIT] to quit.

```

6. Press the [START/STOP] button to start Read/Write test. A countdown indication from 10 to 1 will appear in the R/W test field as the checking is executed. Countdown indication from 10 to 1 will appear three times as three types of checking is executed.
7. When the Read/Write test is completed successfully, “OK” will be shown in the R/W test field. “NG” will be shown if an error is detected.

```

=====
                        IDE HDD Information
=====

Vender ID      : Not exist
Product ID     : ST980815A
Revision       : 3.AL
Capacity       : 74.42[GB]
Serial ID      : Exist
Volume Name    : TYROS3_HD

R/W test      : OK

Press [START/STOP] to test.
Press [DEMO] to format.
Press [EXIT] to quit.

```

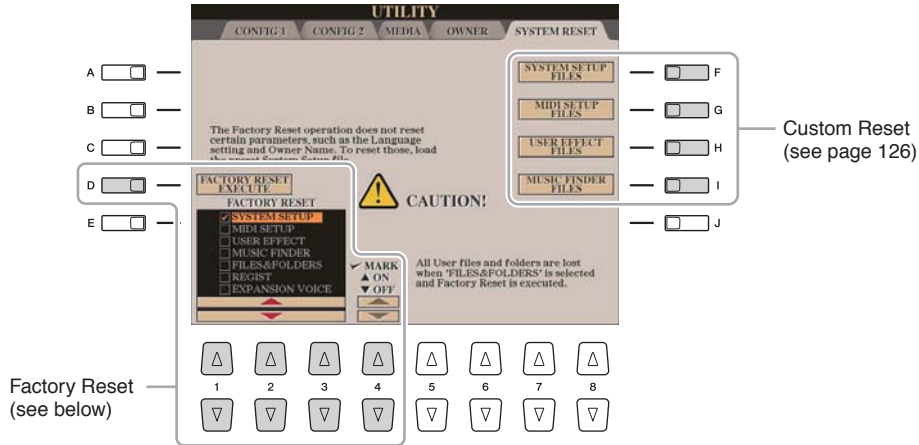
8. When the “OK” is displayed in the Read/Write test, the checking is finished. Turn off the power switch.

• Error messages list

- Unformatted “UNFORMAT DISK”
- Device error “DEVICE ERROR”
- HDD unrecognized “NO DISK”

SYSTEM RESET

There are two reset methods in the SYSTEM RESET display: Factory Reset and Custom Reset.



Factory Reset—Restoring the Factory Programmed Settings

This function lets you restore the status of the Tyros3 to the original factory settings.

- 1 Select the desired item to be restored by using [1▲▼]–[3▲▼] buttons and add a checkmark to it by pressing the [4▲] (MARK ON) button.

To remove the checkmark, press the [4▼] (MARK OFF) button.

SYSTEM SETUP	Restores the System Setup parameters to the original factory settings. Refer to the Data List for details about which parameters belong to the System Setup.
MIDI SETUP	Restores the MIDI settings including the MIDI templates on the USER tab display to the original factory status.
USER EFFECT	Restores the User Effect settings including the user effect types, user master EQ types, user compressor types, and user vocal harmony types created via the Mixing Console display to the original factory settings.
MUSIC FINDER	Restores the Music Finder data (all records) to the original factory settings.
FILES & FOLDERS	Deletes all files and folders stored in the USER tab display.
REGIST	Temporarily deletes the current Registration Memory settings of the selected Bank. The same can be done also by turning the [POWER] button ON while holding the B5 key (rightmost B key on the keyboard).
EXPANSION VOICE	Deletes all Expansion Voices.

- 2 Press the [D] (FACTORY RESET) button to execute the Factory Reset operation for all checkmarked items.

Custom Reset—Saving and Recalling Your Original Settings as a Single File

For the items below, you can save your Original Settings as a Single File for future recall.

- 1** Make all desired settings on the instrument.
- 2** Call up the operation display.
[FUNCTION] → [I] UTILITY → TAB [◀][▶] SYSTEM RESET
- 3** Press one of the [F]–[I] buttons to call up the relevant display for saving your data

[F]	SYSTEM SETUP FILES	Parameters set on the various displays such as the [FUNCTION] → [I] UTILITY and microphone setting display are handled as a single System Setup file. Refer to the Data List for details on which parameters belong to the System Setup.
[G]	MIDI SETUP FILES	The MIDI settings including the MIDI templates on the USER tab display are handled as a single file.
[H]	USER EFFECT FILES	The User Effect settings including the user effect types, user master EQ types, user compressor types, and user vocal harmony types created via the Mixing Console displays are managed as a single file.
[I]	MUSIC FINDER FILES	All the preset and created records of the Music Finder are handled as a single file.

- 4** Use the TAB [◀][▶] buttons to select one of the tabs (other than the PRESET) to which your settings will be saved.
- 5** Press the [6▼] (SAVE) button to save your file.
- 6** To recall your file, press the desired [F]–[I] buttons in the SYSTEM RESET display, then select the desired file.

OS UPDATE

⚠ CAUTIONS

- While updating the program software, do not turn off the power or do not pull out the USB memory.
- It takes about 5 minutes to update the program software.

1 Preparation

Download the Tyros3 updated program from the download page on the YSISS home page to the USB memory.

(YSISS URL>><http://plaza.yamaha.co.jp/ysiss/exindex.nsf>)

(Insert the USB memory containing only the update program into the USB terminal of the Tyros3.)

Tools required for update:

USB memory

(containing only the update program to be installed)

The program software in the USB memory

- Installer:
TYROS3INST.PRG
- The main body of the program data (Boot part):
TYROS3MAINBOOT.PRG
- The main body of the program data:
TYROS3mainprg1.prg - TYROS3mainprg5.prg

2 Executing the software update

2-1 Connect the USB memory to the Tyros3.

Connect the USB memory containing only the update program data to the [USB TO DEVICE] terminal on the front panel.

CAUTIONS: Make sure of the direction of the USB memory before inserting it.

(The reverse insertion may cause the damage on the [USB TO DEVICE] terminal.)

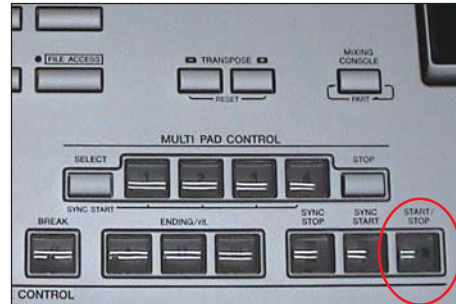
Do not turn off the power during the program update.

Do not remove the USB memory from the [USB TO DEVICE] terminal until the update has been completed.

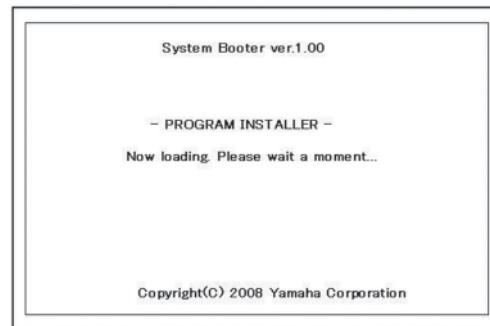


2-2 Installing the update program

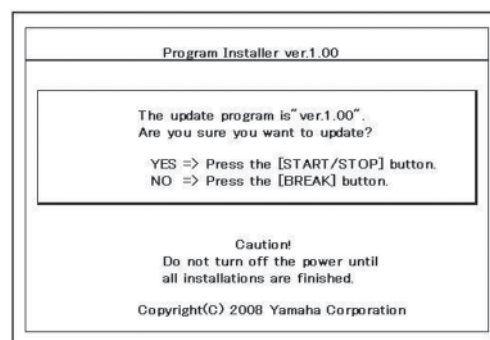
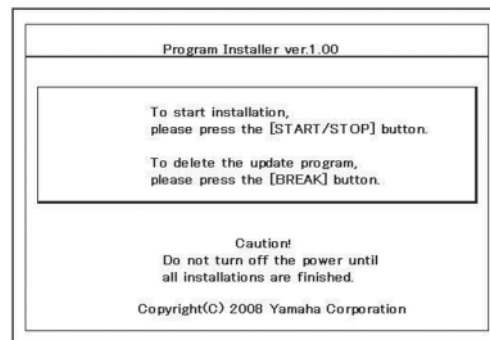
2-2-1 Turn the power on with the [START/STOP] button pressed and held.



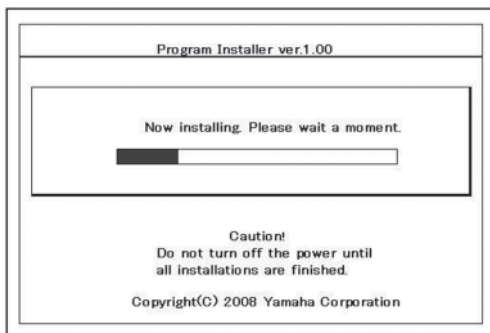
2-2-2 Keep pressing the [START/STOP] button until the following screen is displayed on the LCD.



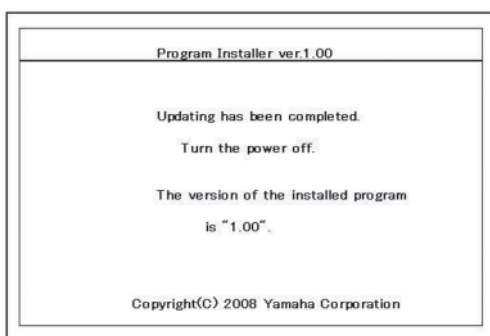
2-2-3 After a while, the following screen is displayed. (Occasionally, it might take more time.)



2-2-4 Press the [START/STOP] button to start the installation.



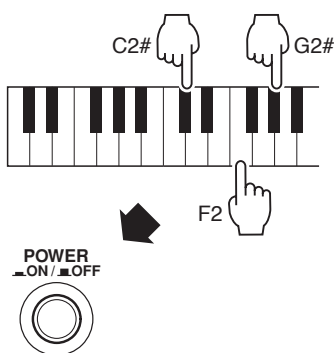
2-2-5 When the installations are finished, the following screen is displayed on the LCD.



2-2-6 Turn the power off.

3 Verifying the program version

3-1 Turn the power on with the [C2#], [F2] and [G2#] keys (C2# major chord) pressed and held.



3-2 “TEST” display appears, and the test mode starts.

3-3 Press the [TEMPO+] button or turn the [DATA ENTRY] dial clockwise to display “001:Version”.

3-4 Press the [START/STOP] button to display the version of each data.

3-5 Confirm that the version of the main program is the same as the version installed this time.

3-6 Press the [START/STOP] button again to return to the wait state for test number.

4 Executing the factory set

4-1 Press the [TEMPO-] button or turn the [DATA ENTRY] dial counterclockwise to display “094:Factory Set”.

4-2 Press the [START/STOP] button to execute the factory set.

4-3 “Factory Set OK” appears on the LCD.

4-4 Press the [START/STOP] button again to return to the wait state for test number.

4-5 Press the [TEMPO+] button or turn the [DATA ENTRY] dial clockwise to display “063:Test Exit”.

4-6 Press the [START/STOP] button to reboot the Tyros3.

4-7 When the main screen appears normally, the factory set is completed. (Occasionally, it might take a few minutes.)

CAUTION: Do not turn the power off before the main screen shows up.

4-8 Turn the power off.

5 Ending the program installation

The program installation is completed here.

● TROUBLESHOOTING

Q1. Power has been turned off or the USB memory has been removed during operation.

A1. It is necessary to re-installation the program. Perform the installation procedure from initial step.

Q2. An error message appears on the screen and installation can not be performed.

A2. Check the following points.

- Is the USB memory is inserted properly?
- Is not there any dirt on the USB memory terminal?
- Does the USB memory contain the whole renewal data (program) in the root directory?
- Is not any damage of the data (program) in the USB memory or the USB memory itself?
- Is the renewal data (program) matched with the model?
- Perform reinstallation using another USB memory.

INITIALIZING INTERNET SETTINGS

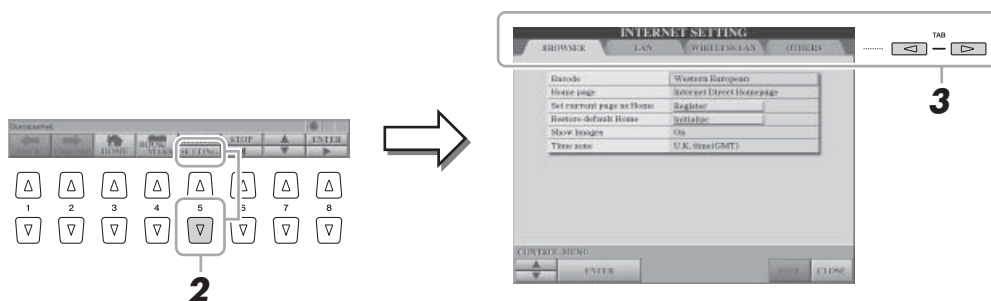
The settings of the Internet function are not initialized when using the Initialize operation of the instrument; Internet settings must be initialized separately, as explained here. Initializing will reset to the default values not only the settings of the browser, but also all settings you have made in the Internet Settings displays (except for the cookies and bookmarks), including those related to Internet connection.

1 Press the INTERNET buttons to connect the Internet.



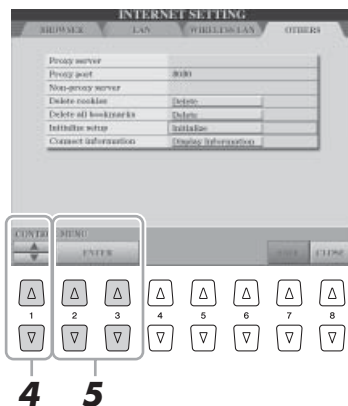
To close the website display and return to the operation display of the instrument, press the [EXIT] button.

2 Press the [5 ▼] (SETTING) button to call up the Internet Settings display.



3 TAB [◀] [▶] button to select the OTHERS.

4 Press the [1 ▲▼] (UP/DOWN) buttons to select "Initialize setup".



5 Use the [2 ▲▼]/ [3 ▲▼] (ENTER) buttons to initialize the Internet settings.

NOTE

Cookies and bookmarks still remain after executing this initialize operation.

To delete the cookies or bookmarks, select "Delete cookies" or "Delete all bookmarks" in step 4.

DATA BACKUP

For maximum data security Yamaha recommends that you copy or save your important data to a USB storage device. This provides a convenient backup if the internal memory is damaged.

1 Insert/connect the backup USB storage device (destination).

NOTE

Completing the backup/restore operation may take a few minutes.

2 Call up the operation display.

[FUNCTION] → [I] UTILITY → TAB [◀] [▶] OWNER



CAUTION

Move the Protected Songs which are saved to the USER display before restoring. If the songs are not moved, the operation deletes the data.

NOTE

To save the Song, Style, Multi Pad, Registration Memory Bank and Voice independently, execute the Copy & Paste operation from the File Selection display.

3 Press the [D] (BACKUP) button to save the data to the USB storage device.

To restore the data, press the [E] (RESTORE) button in this display.

NOTE

To save the Music Finder Record, Effect, MIDI Template and System File, call up the operation display: [FUNCTION] → [I] UTILITY → TAB [◀] [▶] SYSTEM RESET. For more information, refer to the Reference Manual on the website.

■ DISPLAY MESSAGES

[BOOTER]

Displayed message	Meaning	Progress/status	How to service
Now loading. Please wait a while...	Data is being loaded. Wait a while.	The installer file is being loaded.	
Media error!	Media error!	Installer file loading error (media error) Failed in loading the installer file Part of the media is damaged (I/O error)	Replace the installation media and retry.
Installer program checksum error!	Installer checksum error!	Installer file loading error (checksum error) Checksum in the installer file disagrees. File damaged Tampered	Store the installation file again or replace the installation media and perform reinstallation.
Please eject the media.	Remove the media.	When an error occurs	
Please insert the Installer media.	Install the installation media.	A media containing the installer is not connected when the booter is started.	
Installer program not found!	No installer found.	When the installation file is undetected The installer file corresponding to the instrument is not found	
Installer program data error!	Installation program error!	The installer is defective File damaged Tampered Version mismatch	
Installer program data mismatch!	Installation updater error!	When the installer is mismatched Loading of an installer for a different model has been attempted Loading of an installer for a version which cannot be updated has been attempted	Perform reinstallation.
Program error!	Program error!	Starting is disabled because the main program has not been detected The instrument program has not been installed	
Please install the program.	Install the program.	same as above	
Error! Unformatted or incompatible data.	Unformatted or unsupported error!	The installer cannot be loaded from the installer The media is not formatted in any one format of FAT12, FAT16 or FAT32 Unformatted System area in the media is damaged	Format the media in FAT12, FAT16 or FAT32 system.

[INSTALLER]

Displayed message	Meaning	Progress/status	How to service
Now loading. Please wait a moment...	Data is being loaded. Wait a while.	Data is being loaded	
Now installing. Please wait a moment...	During installing. Wait a while.	During installation of data	
Now deleting. Please wait a moment...	Data is being deleted. Wait a while.	During data deletion	
Please insert the media.	Install the media.	There is no media from which data should be loaded	Reinsert the media.
Install data does not exist.	Upgrading data not found.	Data not contained in the media	Install the installation file again.
Can't delete the install data.	The version upgrading data can not be deleted.	When an error occurs (Media writing disabled)	Release the protect of the media.
E001 Install data address error!	E001 Data address error!	When an error occurs (Installation data error)	Install the installation file again.
E002 Install data size error!	E002 Data size error!	When an error occurs (Installation data error)	
E003 Install data checksum error!	E003 Data checksum error!	When an error occurs (Installation data error)	
Install data ID error!	Data ID error!	When an error occurs (Installation data error)	
Install data version error!	Data version error!	When an error occurs (Installation data error)	
Install data read error!	Data loading error!	When an error occurs (Installation data error)	
E004 Flash ID error!	E004 Flash ID error!	When an error occurs (Flash writing disabled)	Perform reinstallation. Replace the Flash ROM even if the result is undesirable after the reinstallation.
E005 Flash erase error!	E005 Flash deletion error!	When an error occurs (Flash writing disabled)	
E006 Flash write error!	E006 Flash writing error!	When an error occurs (Flash writing disabled)	
E007 Flash verify error!	E007 Flash verify error!	When an error occurs (Flash writing disabled)	
E008 Flash checksum error!	E008 Flash checksum error!	When an error occurs (Flash writing disabled)	
Updating has been completed. Turn the power off. The version of the installed program is X.XX.	Installation completed. Turn off the power and then turn on again. The version of the installed program is "X.XX".	When the installing completed	
To start installation, please press the [START/STOP] button. To delete the update program, please press the [BREAK] button.	To start the installation, press the [START/STOP] button. To delete the version upgrading data, press the [BREAK] button.	When the installer is started.	
The update program is ver.X.XX. Are you sure you want to update? YES: Press the [START/STOP] button. NO: Press the [BREAK] button.	Version upgrading data is "ver.X.XX". Do you start installing? YES: Press the [START/STOP] button. NO: Press the [BREAK] button.	When the completion of the installation is detected	
The update program is ver.X.XX. Are you sure you want to delete? YES: Press the [START/STOP] button. NO: Press the [BREAK] button.	Version upgrading data is "ver.X.XX". Do you delete the data? YES: Press the [START/STOP] button. NO: Press the [BREAK] button.	When the deletion of the data is detected	

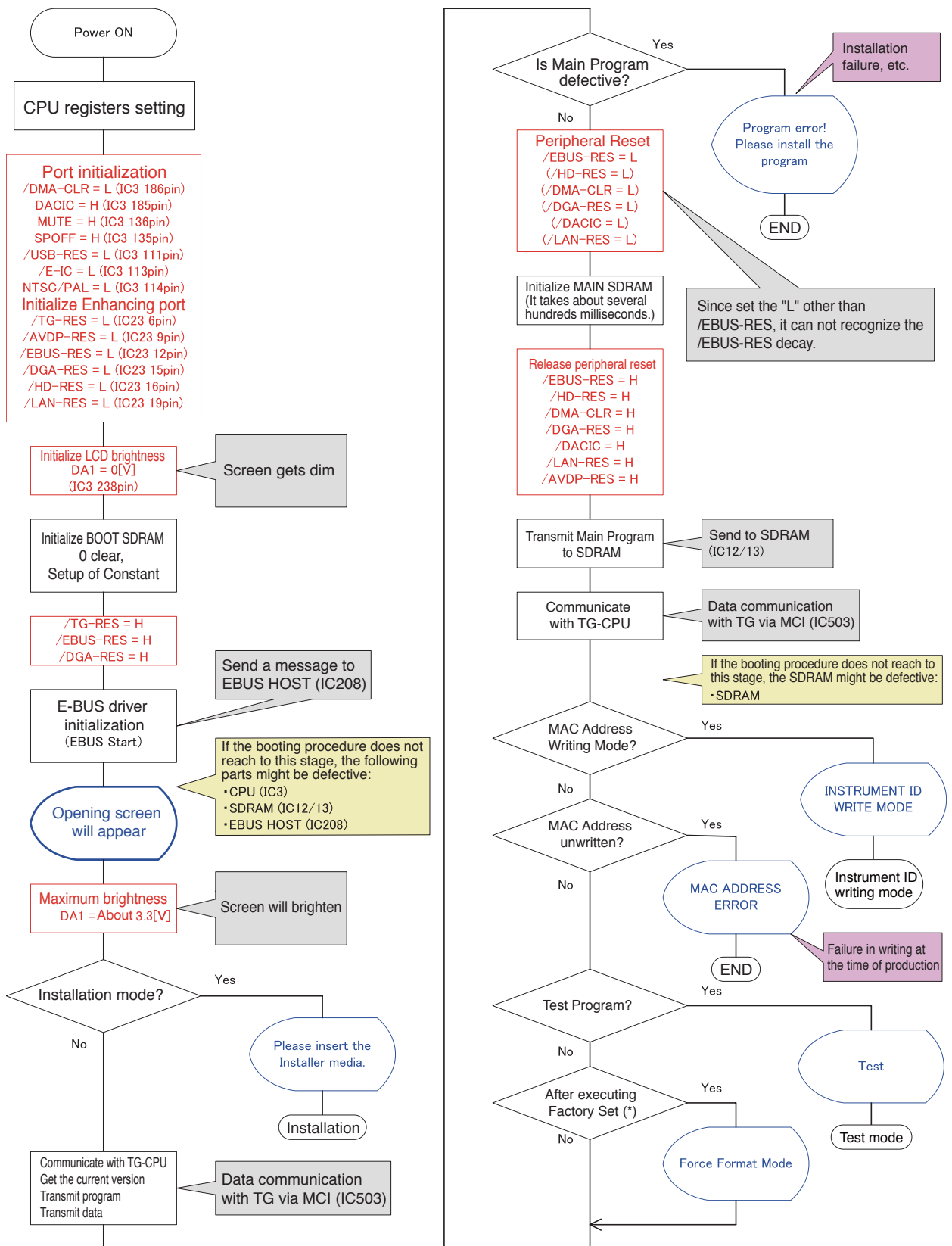
[At start]

Displayed message	Meaning	Progress/status	How to service
Improper power shut down! Backup data and/or User files have been lost.	Power has not been turned off normally. Backup data and user file have been lost.	Data is being restored as defect has been detected in the data backed up in the data flash.	
Initializing system setup.	System setup being initialized	During execution of Factory Set	
Force Format Mode.	Forced clear	Factory Reset is performed in the forced clear mode	
Initializing registration backup.	Registration backup being initialized	When the registration backup data is cleared	
Data Flash ROM Device Error.	Data flash error	Starting is disabled because the data flash is damaged	Perform reinstallation. Replace the Flash ROM even if the result is undesirable after the reinstallation.
MAC ADDRESS ERROR !!	MAC address error	MAC address is not written or defective	

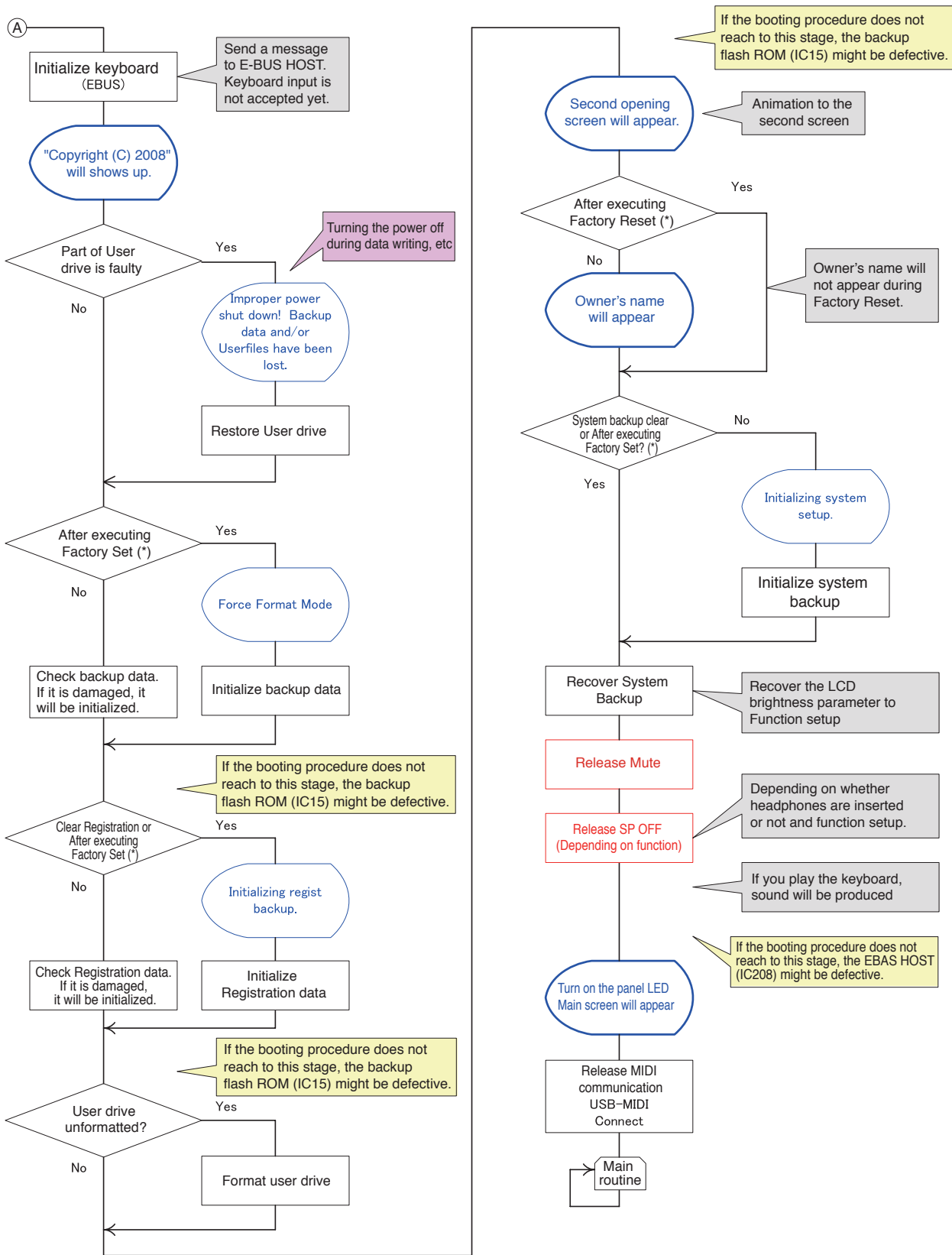
[ASSERTION]

Displayed message	Meaning	Progress/status	How to service
----- Unexpected error! Turn the power off and on again ----- Parameter 1 Parameter 2 / Parameter 3	Fatal error occurred. Turn off the power and then turn on again.	Unexpected error System down	

SYSTEM BOOTING FLOWCHART



* "After executing Factory Set" refers to the condition when the power is turned on after executing "Factory Set" in the Test Program.



MIDI IMPLEMENTATION CHART

YAMAHA [Digital Workstation]
Model TYROS3 MIDI Implementation Chart

Date:17-Apr-2008
Version : 1.0

Function...	Transmitted	Recognized	Remarks
Basic Default Channel Changed	1 - 16 1 - 16	1 - 16 1 - 16	
Mode Default Messages Altered	3 x *****	3 x x	
Note Number : True voice	0 - 127 *****	0 - 127 0 - 127	
Velocity Note ON Note OFF	o 9nH,v=1-127 x 9nH,v=0	o 9nH,v=1-127 x	
After Key's Touch Ch's	x o	o o	
Pitch Bend	o	o 0-24 semi	
Control Change	0,32 o 1,5,7,10,11 o 6,38 o 64,65,66,67 o 71,72,73,74 o 80,81 o 84 o 91,93,94 o 96,97 x 98,99 o 100,101 o	o o o o o o o o o o o	Bank Select Data Entry Sound Controller Portamento Cntrl Effect Depth RPN Inc,Dec NRPN LSB,MSB RPN LSB,MSB
Prog Change : True #	o 0 - 127 *****	o 0 - 127	
System Exclusive	o	o	
: Song Pos. Common : Song Sel. : Tune	x x x	x x x	
System :Clock Real Time:Commands	o o	o o	
Aux :All Sound OFF :Reset All Cntrls :Local ON/OFF :All Notes OFF Mes- :Active Sense sages:Reset	x x x x o x	o(120,126,127) o(121) o(122) o(123-125) o x	
Notes:			

Mode 1 : OMNI ON , POLY
Mode 3 : OMNI OFF , POLY

Mode 2 : OMNI ON , MONO
Mode 4 : OMNI OFF , MONO

o : Yes
x : No

■ MIDI DATA FORMAT

Many MIDI messages listed in the MIDI Data Format are expressed in decimal numbers, binary numbers and hexadecimal numbers. Hexa-decimal numbers may include the letter "H" as a suffix. Also, "n" can freely be defined as any whole number. To enter data/values, refer to the table below.

Decimal	Hexadecimal	Binary
0	00	0000 0000
1	01	0000 0001
2	02	0000 0010
3	03	0000 0011
4	04	0000 0100
5	05	0000 0101
6	06	0000 0110
7	07	0000 0111
8	08	0000 1000
9	09	0000 1001
10	0A	0000 1010
11	0B	0000 1011
12	0C	0000 1100
13	0D	0000 1101
14	0E	0000 1110
15	0F	0000 1111
16	10	0001 0000
17	11	0001 0001
18	12	0001 0010
19	13	0001 0011
20	14	0001 0100
21	15	0001 0101
22	16	0001 0110
23	17	0001 0111
24	18	0001 1000
25	19	0001 1001
26	1A	0001 1010
27	1B	0001 1011
28	1C	0001 1100
29	1D	0001 1101
30	1E	0001 1110
31	1F	0001 1111

Decimal	Hexadecimal	Binary
32	20	0010 0000
33	21	0010 0001
34	22	0010 0010
35	23	0010 0011
36	24	0010 0100
37	25	0010 0101
38	26	0010 0110
39	27	0010 0111
40	28	0010 1000
41	29	0010 1001
42	2A	0010 1010
43	2B	0010 1011
44	2C	0010 1100
45	2D	0010 1101
46	2E	0010 1110
47	2F	0010 1111
48	30	0011 0000
49	31	0011 0001
50	32	0011 0010
51	33	0011 0011
52	34	0011 0100
53	35	0011 0101
54	36	0011 0110
55	37	0011 0111
56	38	0011 1000
57	39	0011 1001
58	3A	0011 1010
59	3B	0011 1011
60	3C	0011 1100
61	3D	0011 1101
62	3E	0011 1110
63	3F	0011 1111

Decimal	Hexadecimal	Binary
64	40	0100 0000
65	41	0100 0001
66	42	0100 0010
67	43	0100 0011
68	44	0100 0100
69	45	0100 0101
70	46	0100 0110
71	47	0100 0111
72	48	0100 1000
73	49	0100 1001
74	4A	0100 1010
75	4B	0100 1011
76	4C	0100 1100
77	4D	0100 1101
78	4E	0100 1110
79	4F	0100 1111
80	50	0101 0000
81	51	0101 0001
82	52	0101 0010
83	53	0101 0011
84	54	0101 0100
85	55	0101 0101
86	56	0101 0110
87	57	0101 0111
88	58	0101 1000
89	59	0101 1001
90	5A	0101 1010
91	5B	0101 1011
92	5C	0101 1100
93	5D	0101 1101
94	5E	0101 1110
95	5F	0101 1111

Decimal	Hexadecimal	Binary
96	60	0110 0000
97	61	0110 0001
98	62	0110 0010
99	63	0110 0011
100	64	0110 0100
101	65	0110 0101
102	66	0110 0110
103	67	0110 0111
104	68	0110 1000
105	69	0110 1001
106	6A	0110 1010
107	6B	0110 1011
108	6C	0110 1100
109	6D	0110 1101
110	6E	0110 1110
111	6F	0110 1111
112	70	0111 0000
113	71	0111 0001
114	72	0111 0010
115	73	0111 0011
116	74	0111 0100
117	75	0111 0101
118	76	0111 0110
119	77	0111 0111
120	78	0111 1000
121	79	0111 1001
122	7A	0111 1010
123	7B	0111 1011
124	7C	0111 1100
125	7D	0111 1101
126	7E	0111 1110
127	7F	0111 1111

• Except the table above, for example 144-159(decimal)/9nH/10010000-1001 1111(binary) denotes the Note On Message for each channel (1-16). 176-191/BnH/1011 0000-1011 1111 denotes the Control Change Message for each channel (1-16). 192-207/CnH/1100 0000-1100 1111 denotes the Program Change Message for each channel (1-16). 240/F0H/1111 0000 denotes the start of a Sys-tem Exclusive Message. 247/F7H/1111 0111 denotes the end of a System Exclusive Message.

- aaH (hexidecimal)/0aaaaaaa (binary) denotes the data address. The address contains High, Mid, and Low.
- bbH/0bbbbbbb denotes the byte count.
- ccH/0ccccccc denotes the check sum.
- ddH/0ddddddd denotes the data/value.

MIDI CHANNEL MESSAGE (1)

MIDI Events	Status byte		1st Data byte		2nd Data byte		Voice		MIDI Reception				MIDI Transmission				[Song Creator]										
	Status		Data (HEX)	Parameter	Data (HEX)	Parameter	Regular/Drum/Organ Voice	Mic/Vocal Harmony	Song	Right1 Right2 Right3 Left	Keyboard	Style	Extra	Right1 Right2 Right3 Left	M.Pad	Style	Song	Upper Lower	PLAY	REW	REC						
Key Off [GM1] [GM2]	8nH	(n:Channel Number)	kk	Key no. (0-127)	vv	Velocity(0-127)	○	○	○	○	○	○	○	○	○	○	○	○	○	○	○	○					
Key On [GM1] [GM2]	9nH	(n:Channel Number)	kk	Key no. (0-127)	vv	Key On : vv=1-127 Key Off : vv=0	○	○	○	○	○	○	○	●	○	○	○	○	○	○	○	○					
Control Change	BnH		0 (00H)	Bank Select MSB [GM2]	0 (00H) 8 (08H) 8 (08H) 8 (08H) 62 (3EH) 63 (3FH) 64 (40H) 104 (68H) 120 (78H) 121 (79H) 126 (7EH) 127 (7FH)	Normal MegaVoice SA Voice SA2 Voice Custom Drum Voice Custom Voice SFX Voice Normal GM2 Rhythm GM2 Normal SFX kit Drum kit	○	X	○	○	○	○	○	○	○	○	○	○	○	○	○	○	○	○	○		
			1 (01H)	Modulation [GM1] [GM2]	0-127 (00H...7FH)	Data	○	X	○	○	○	○	○	○	○	○	○	○	○	○	○	○	○	○	○	○	
			5 (05H)	Portamento Time [GM2]	0-127 (00H...7FH)	Data	○	X	○	○	○	○	○	X	○	○	○	○	○	○	○	○	○	○	○	○	○
			6 (06H)	Data Entry MSB [GM2]	0-127 (00H...7FH)	Data	○	○	○	○	○	○	○	○	○	○	○	○	○	○	○	○	○	○	○	○	○
			7 (07H)	Main Volume [GM1] [GM2]	0-127 (00H...7FH)	Data	○	○	○	○	○	○	○	○	○	○	○	○	○	○	○	○	○	○	○	○	○
			10 (0AH)	Panpot [GM1] [GM2]	0-127 (00H...7FH)	L64...C...R63	○	○	○	○	○	○	○	○	○	○	○	○	○	○	○	○	○	○	○	○	○
			11 (0BH)	Expression [GM1] [GM2]	0-127 (00H...7FH)	Data	○	X	○	○	○	○	○	○	○	○	○	○	○	○	○	○	○	○	○	○	○
			32 (20H)	Bank Select LSB [GM2]	0-127 (00H...7FH)	Data	○	X	○	○	○	○	○	○	○	○	○	○	○	○	○	○	○	○	○	○	○
			38 (26H)	Data Entry LSB [GM2]	0-127 (00H...7FH)	Data	○	X	○	○	○	○	○	X	○	○	○	○	○	○	○	○	○	○	○	○	○
			64 (40H)	Sustain (Damper) [GM1] [GM2]	0-127 (00H...7FH)	Data	○	○	○	○	○	○	○	X	○	○	○	○	○	○	○	○	○	○	○	○	○
			65 (41H)	Portamento [GM2]	0-127 (00H...7FH)	0...63, 64...127 (OFF, ON)	○	X	○	○	○	○	○	X	○	○	○	○	○	○	○	○	○	○	○	○	○
			66 (42H)	Sostenuto [GM2]	0-127 (00H...7FH)	0...63, 64...127 (OFF, ON)	○	X	○	○	○	○	○	X	○	○	○	○	○	○	○	○	○	○	○	○	○
			67 (43H)	Soft Pedal [GM2]	0-127 (00H...7FH)	0...63, 64...127 (OFF, ON)	○	X	○	○	○	○	○	X	○	○	○	○	○	○	○	○	○	○	○	○	○
			71 (47H)	Harmonic Content [GM2]	0-127 (00H...7FH)	-64...0...+63	○	X	○	○	○	○	○	○	○	○	○	○	○	○	○	○	○	○	○	○	○
			72 (48H)	Release Time [GM2]	0-127 (00H...7FH)	-64...0...+63	○	X	○	○	○	○	○	○	○	○	○	○	○	○	○	○	○	○	○	○	○
			73 (49H)	Attack Time [GM2]	0-127 (00H...7FH)	-64...0...+63	○	X	○	○	○	○	○	○	○	○	○	○	○	○	○	○	○	○	○	○	○
			74 (4AH)	Brightness [GM2]	0-127 (00H...7FH)	-64...0...+63	○	X	○	○	○	○	○	○	○	○	○	○	○	○	○	○	○	○	○	○	○
			75 (4BH)	Decay Time [GM2]	0-127 (00H...7FH)	-64...0...+63	○	X	○	○	○	○	○	○	○	○	○	○	○	○	○	○	○	○	○	○	○
			76 (4CH)	Vibrato Rate [GM2]	0-127 (00H...7FH)	-64...0...+63	○	X	○	○	○	○	○	○	○	○	○	○	○	○	○	○	○	○	○	○	○
			77 (4DH)	Vibrato Depth [GM2]	0-127 (00H...7FH)	-64...0...+63	○	X	○	○	○	○	○	○	○	○	○	○	○	○	○	○	○	○	○	○	○
			78 (4EH)	Vibrato Delay [GM2]	0-127 (00H...7FH)	-64...0...+63	○	X	○	○	○	○	○	○	○	○	○	○	○	○	○	○	○	○	○	○	○
			80 (50H)	General Purpose Controller (Articulation 1)	0-127 (00H...7FH)	0 : OFF 127 : ON	○	X	○	○	X	○	X	X	X	○	○	○	○	○	○	○	○	○	○	○	○
			81 (51H)	General Purpose Controller (Articulation 2)	0-127 (00H...7FH)	0 : OFF 127 : ON	○	X	○	○	X	○	X	X	X	○	○	○	○	○	○	○	○	○	○	○	○
			84 (54H)	Portamento Control	0-127 (00H...7FH)	Key no. (0-127)	○	X	○	○	○	○	X	○	○	○	○	○	○	○	○	○	○	○	○	○	○

● : Transmitted via panel operations and keyboard/controller performances. ○ : Available

[GM1]...GM Required Parameter
[GM2]...GM Leve2 Required Parameter

MIDI Events	Status byte	[MIDI]																[Song Creator]		
		1st Data byte		2nd Data byte		Voice		MIDI Reception				MIDI Transmission				PLAY		REC		
		Status	Data (HEX)	Parameter	Data (HEX)	Parameter	Regular/Drum/Organ Voice	Mic/Vocal Harmony	Song	Right1 Right2 Right3 Left	Keyboard	Style	Extra	Right1 Right2 Right3 Left	M.Pad	Style	Song	Upper Lower	PLAY	REW
		91 (5BH)	Effect1 Depth (Reverb Send Level) [GM2]	0-127 (00H...7FH)	Data	O	O (A/D Part Receive Channel)	O	O	O (All Keyboard parts)	O	O	●	●	●	●	X	O	O	O
		93 (5DH)	Effect3 Depth (Chorus Send Level) [GM2]	0-127 (00H...7FH)	Data	O	O (A/D Part Receive Channel)	O	O	O (All Keyboard parts)	O	O	●	●	●	●	X	O	O	O
		94 (5EH)	Effect4 Depth (Variation Send Level)	0-127 (00H...7FH)	Data	O	X	O	O	O (All Keyboard parts)	O	O	O	O	●	●	X	O	O	X
		96 (60H)	RPN Increment	- -	The data byte is ignored.	O	O (Harmony Channel/Melody Channel)	O	O	X	O	O	X	O	X	O	X	O	X	X
		97 (61H)	RPN Decrement	- -	The data byte is ignored.	O	O (Harmony Channel/Melody Channel)	O	O	X	O	O	X	O	X	O	X	O	X	X
		98 (62H)	NRPN LSB	0-127 (00H...7FH)	Data	O	O (Harmony Channel/Melody Channel)	O	O	X	O	O	●	O	O	O	X	O	O	O
		99 (63H)	NRPN MSB	0-127 (00H...7FH)	Data	O	O (Harmony Channel/Melody Channel)	O	O	X	O	O	●	O	O	O	X	O	O	O
		100 (64H)	RPN LSB [GM2]	0-127 (00H...7FH)	Data	O	O (Harmony Channel/Melody Channel)	O	O	O (All Keyboard parts)	O	O	●	O	O	O	X	O	O	O
		101 (65H)	RPN MSB [GM2]	0-127 (00H...7FH)	Data	O	O (Harmony Channel/Melody Channel)	O	O	O (All Keyboard parts)	O	O	●	O	O	O	X	O	O	O
Mode Message	BnH (n:Channel Number)	120 (78H)	All Sound Off [GM2]	0 (00H)	Data	O	X	O	O	O (All Keyboard parts)	O	O	X	O	X	O	X	O	X	X
		121 (79H)	Reset All Controllers [GM1] [GM2]	0 (00H)	Data	O	X	O	X	X	X	X	X	O	X	O	X	O	X	X
		122 (7AH)	Local Control	0 127 (00H) (7FH)	OFF ON	-	-			O			X	X	X	X	X	X	X	X
		123 (7BH)	All Note Off [GM1] [GM2]	0 (00H)	Data	O	O (Harmony Channel/Melody Channel)	O	O	O (All Keyboard parts)	O	O	X	O	X	O	X	O	X	X
		124 (7CH)	Omni Off [GM2]	0 (00H)	Data	O	X	O	X	X	X	X	X	O	X	O	X	O	X	X
		125 (7DH)	Omni On [GM2]	0 (00H)	Data	O	X	O	X	X	X	X	X	O	X	O	X	O	X	X
		126 (7EH)	Mono [GM2]	0-16 (00H...10H)	Data	O	X	O	X	X	X	X	X	O	X	O	X	O	X	X
		127 (7FH)	Poly [GM2]	0 (00H)	Data	O	X	O	X	X	X	X	X	O	X	O	X	O	X	X
Program Change [GM1] [GM2]	CnH (n:Channel Number)	pp (00H...7FH)	Voice Number (0-127)	- -	-	O	X	O	O	O (Right1)	O	O	●	O	●	●	X	O	O	O
Channel After Touch [GM1] [GM2]	DnH (n:Channel Number)	vv (00H...7FH)	Data	- -	-	O	X	O	O	O (All Keyboard parts)	X	O	X	O	X	O	X	O	X	O
Polyphonic After Touch	AnH (n:Channel Number)	kk (00H...7FH)	Key no. (0-127)	vv (00H...7FH)	Data	O	X	O	X	X	X	X	X	X	X	O	X	O	X	X
Pitch Bend Change [GM1] [GM2]	EnH (n:Channel Number)	cc (00H...7FH)	LSB	dd (00H...7FH)	MSB	O	O (Harmony Channel/Melody Channel)	O	O	O (All Keyboard parts)	O	O	●	O	O	O	●	O	O	O
Realtime Message	F8H MIDI Clock	- -	-	- -	-	-	-	O (Received when the Clock is set to MIDI A, MIDI B, USB1, or USB2.)				O (Transmitted when the Clock is set to Internal and the Transmit Clock is set to on.)				-	-	-		
	FAH Start	- -	-	- -	-	-	-	O (Received when the Clock is set to MIDI A, MIDI B, USB1, or USB2.)				O (Transmitted when the Transmit Clock is set to on.)				-	-	-		
	FBH Continue	- -	-	- -	-	-	-	X				X				-	-	-		
	FCH Stop	- -	-	- -	-	-	-	O (Received when the Clock is set to MIDI A, MIDI B, USB1, or USB2.)				O (Transmitted when the Transmit Clock is set to on.)				-	-	-		
	FEH Active Sense [GM2]	- -	-	- -	-	-	-	O				O				-	-	-		
	FFH System Reset	- -	-	- -	-	-	-	X				X				-	-	-		

● : Transmitted via panel operations and keyboard/controller performances. O : Available

About Mic/Vocal Harmony column:

Harmony Channel/Melody Channel: The relevant parameters are received by the song part designated by the Effect's Harmony Channel Parameter or Melody Channel Parameter.
A/D Part Receive Channel: The relevant parameters are received by the song part designated by the AD Part Receive Channel of the XG format.

[GM1]...GM Required Parameter

[GM2]...GM Level2 Required Parameter

MIDI CHANNEL MESSAGE (2)

NRPN				[MIDI]										[Song Creator]						
NRPN	MSB	LSB	Data Entry	Parameter	Data Range	Voice		MIDI Reception					MIDI Transmission					PLAY		REC
						Regular/ Drum/ Organ Voice	Mic/Vocal Harmony	Song	Right1 Right2 Right3 Left	Keyboard	Style	Extra	Right1 Right2 Right3 Left	M.Pad	Style	Song	Upper Lower	PLAY	REW	
01H	08H	mmH	--	Vibrato Rate	mm : 00H-40H-7FH (-64...0...+63)	O	O (Harmony Channel/ Melody Channel)	O	O	X	O	O	●	O	O	O	X	O	O	O
01H	09H	mmH	--	Vibrato Depth	mm : 00H-40H-7FH (-64...0...+63)	O	O (Harmony Channel/ Melody Channel)	O	O	X	O	O	●	O	O	O	X	O	O	O
01H	0AH	mmH	--	Vibrato Delay	mm : 00H-40H-7FH (-64...0...+63)	O	O (Harmony Channel/ Melody Channel)	O	O	X	O	O	●	O	O	O	X	O	O	O
01H	20H	mmH	--	Low Pass Filter Cutoff Frequency	mm : 00H-40H-7FH (-64...0...+63)	O	X	O	X	X	O	X	X	O	X	O	X	O	O	X
01H	21H	mmH	--	Low Pass Filter Resonance	mm : 00H-40H-7FH (-64...0...+63)	O	X	O	X	X	O	X	X	O	X	O	X	O	O	X
01H	30H	mmH	--	EQ Bass Gain	mm : 00H-40H-7FH (-64...0...+63)	O	X	O	X	X	O	X	X	X	X	O	X	O	O	X
01H	31H	mmH	--	EQ Treble Gain	mm : 00H-40H-7FH (-64...0...+63)	O	X	O	X	X	O	X	X	X	X	O	X	O	O	X
01H	34H	mmH	--	EQ Bass Frequency	mm : 04H-28H (32...2.0k[Hz])	O	X	O	X	X	X	X	X	X	X	O	X	O	O	X
01H	35H	mmH	--	EQ Treble Frequency	mm : 1CH-3AH (500...16.0k[Hz])	O	X	O	X	X	X	X	X	X	X	O	X	O	O	X
01H	63H	mmH	--	EG Attack Time	mm : 00H-40H-7FH (-64...0...+63)	O	X	O	X	X	O	X	X	O	X	O	X	O	O	X
01H	64H	mmH	--	EG Decay Time	mm : 00H-40H-7FH (-64...0...+63)	O	X	O	O	X	O	O	●	O	O	O	X	O	O	O
01H	66H	mmH	--	EG Release	mm : 00H-40H-7FH (-64...0...+63)	O	X	O	X	X	O	X	X	O	X	O	X	O	O	X
14H	rrH	mmH	--	Drum Low Pass Filter Cutoff Frequency	rr : drum instrument note number mm : 00H-40H-7FH (-64...0...+63)	O (Drum Only)	X	O	X	X	X	X	X	X	O	O	X	O	X	X
15H	rrH	mmH	--	Drum Low Pass Filter Resonance	rr : drum instrument note number mm : 00H-40H-7FH (-64...0...+63)	O (Drum Only)	X	O	X	X	X	X	X	X	O	O	X	O	X	X
16H	rrH	mmH	--	Drum EG Attack Rate	rr : drum instrument note number mm : 00H-40H-7FH (-64...0...+63)	O (Drum Only)	X	O	X	X	X	X	X	X	O	O	X	O	X	X
17H	rrH	mmH	--	Drum EG Decay Rate	rr : drum instrument note number mm : 00H-40H-7FH (-64...0...+63)	O (Drum Only)	X	O	X	X	X	X	X	X	O	O	X	O	X	X
18H	rrH	mmH	--	Drum Pitch Coarse	rr : drum instrument note number mm : 00H-40H-7FH (-64...0...+63)	O (Drum Only)	X	O	X	X	X	X	X	X	O	O	X	O	X	X
19H	rrH	mmH	--	Drum Pitch Fine	rr : drum instrument note number mm : 00H-40H-7FH (-64...0...+63)	O (Drum Only)	X	O	X	X	X	X	X	X	O	O	X	O	X	X
1AH	rrH	mmH	--	Drum Level	rr : drum instrument note number mm : 00H-7FH (0...127)	O (Drum Only)	X	O	X	X	X	X	X	X	O	O	X	O	X	X
1CH	rrH	mmH	--	Drum Pan	rr : drum instrument note number mm : 00H, 01H- 40H-7FH (RND, L63...C...R63)	O (Drum Only)	X	O	X	X	X	X	X	X	O	O	X	O	X	X
1DH	rrH	mmH	--	Drum Reverb Send Level	rr : drum instrument note number mm : 00H-7FH (0...127)	O (Drum Only)	X	O	X	X	X	X	X	X	O	O	X	O	X	X
1EH	rrH	mmH	--	Drum Chorus Send Level	rr : drum instrument note number mm : 00H-7FH (0...127)	O (Drum Only)	X	O	X	X	X	X	X	X	O	O	X	O	X	X
1FH	rrH	mmH	--	Drum Variation Send Level	rr : drum instrument note number mm : 00H-7FH (0...127) (Variation Connection= SYSTEM) mm : 00H, 01H- 7FH (OFF, ON) (Variation Connection= INSERTION)	O (Drum Only)	X	O	X	X	X	X	X	X	O	O	X	O	X	X
30H	rrH	mmH	--	Drum EQ Bass Gain	rr : drum instrument note number mm : 00H-7FH (0...127)	X	X	X	X	X	X	X	X	X	X	O	X	X	X	X
31H	rrH	mmH	--	Drum EQ Treble Gain	rr : drum instrument note number mm : 00H-7FH (0...127)	X	X	X	X	X	X	X	X	X	X	O	X	X	X	X
34H	rrH	mmH	--	Drum EQ Bass Frequency	rr : drum instrument note number mm : 04H-28H (32...2.0[Hz])	X	X	X	X	X	X	X	X	X	X	O	X	X	X	X
35H	rrH	mmH	--	Drum EQ Treble Frequency	rr : drum instrument note number mm : 1CH-3AH (500...16.0[Hz])	X	X	X	X	X	X	X	X	X	X	O	X	X	X	X

● : Transmitted via panel operations and keyboard/controller performances. ○ : Available

NRPN MSB: 14H-35H (or drums) message is accepted as long as the channel is set with a drum voice.
Data Entry LSB: Ignored.

NRPN (VocalHarmony)

NRPN				Data Entry	Parameter	Data Range	Voice		[MIDI]					[Song Creator]								
MSB	LSB	MSB	LSB				Regular/ Drum/ Organ Voice	Mic/Vocal Harmony	MIDI Reception					MIDI Transmission				PLAY		REC		
									Song	Right1 Right2 Right3 Left	Keyboard	Style	Extra	Right1 Right2 Right3 Left	M.Pad	Style	Song	Upper Lower	PLAY	REW	From panel (Right1/ Right2/ Right3/ Left)	
00H	00H	mmH	--	Harmony Mute	mm : 00H-3FH, 40H-7FH (Off, On)		X	O (Harmony Channel)	X	X	X	X	X	X	X	X	O	X	O	X	X	X
01H	1AH	mmH	--	Detune Modulation	mm : 00H-7FH (0...127)		X	O (Harmony Channel)	X	X	X	X	X	X	X	X	O	X	O	X	X	X
02H	10H	mmH	--	Harmony1 Volume	mm : 00H-7FH (0...127)		X	O (Harmony Channel)	X	X	X	X	X	X	X	X	●	X	O	X	X	X
02H	11H	mmH	--	Harmony2 Volume	mm : 00H-7FH (0...127)		X	O (Harmony Channel)	X	X	X	X	X	X	X	X	●	X	O	X	X	X
02H	12H	mmH	--	Harmony3 Volume	mm : 00H-7FH (0...127)		X	O (Harmony Channel)	X	X	X	X	X	X	X	X	●	X	O	X	X	X
02H	20H	mmH	--	Harmony1 Pan	mm : 00H, 01H-40H-7FH (RND, L63...C...R63)		X	O (Harmony Channel)	X	X	X	X	X	X	X	X	●	X	O	X	X	X
02H	21H	mmH	--	Harmony2 Pan	mm : 00H, 01H-40H-7FH (RND, L63...C...R63)		X	O (Harmony Channel)	X	X	X	X	X	X	X	X	●	X	O	X	X	X
02H	22H	mmH	--	Harmony3 Pan	mm : 00H, 01H-40H-7FH (RND, L63...C...R63)		X	O (Harmony Channel)	X	X	X	X	X	X	X	X	●	X	O	X	X	X
02H	30H	mmH	--	Harmony1 Detune	mm : 00H-40H-7FH (-64...0...+63)		X	O (Harmony Channel)	X	X	X	X	X	X	X	X	●	X	O	X	X	X
02H	31H	mmH	--	Harmony2 Detune	mm : 00H-40H-7FH (-64...0...+63)		X	O (Harmony Channel)	X	X	X	X	X	X	X	X	●	X	O	X	X	X
02H	32H	mmH	--	Harmony3 Detune	mm : 00H-40H-7FH (-64...0...+63)		X	O (Harmony Channel)	X	X	X	X	X	X	X	X	●	X	O	X	X	X

● : Transmitted via panel operations and keyboard/controller performances. O : Available

Data Entry LSB: Ignored.

RPN

RPN				Data Entry	Parameter	Data Range	Voice		[MIDI]					[Song Creator]								
MSB	LSB	MSB	LSB				Regular/ Drum/ Organ Voice	Mic/Vocal Harmony	MIDI Reception					MIDI Transmission				PLAY		REC		
									Song	Right1 Right2 Right3m Left	Keyboard	Style	Extra	Right1 Right2 Right3 Left	M.Pad	Style	Song	Upper Lower	PLAY	REW	From panel (Right1/ Right2/ Right3/ Left)	
00H	00H	mmH	--	Pitch Bend Sensitivity [GM1][GM2]	mm : 00H-18H (0...+24 [semitones])		O	O (Harmony Channel/ Melody Channel)	O	O	O (All Keyboard parts)	O	O	●	O	O	O	X	O	O	O	O
00H	01H	mmH	IIH	Fine Tune [GM1][GM2]	mm II : 00H 00H -100[cent] ... mm II : 40H 00H 0[cent] ... mm II : 7FH 7FH 100[cent]		O	X	O	O	O (All Keyboard parts)	O	O	●	O	O	O	X	O	O	O	O
00H	02H	mmH	--	Coarse Tune [GM1][GM2]	mm : 28H-40H-58H (-24...0...+24[semitones])		O	X	O	O	O (All Keyboard parts)	O	O	X	O	O	O	X	O	O	O	X
00H	05H	mmH	IIH	Modulation Sensitivity [GM2]	mm : Specified in semitone steps II : Specified in 100/128 cent steps		O	X	O	X	X	X	X	X	X	X	O	X	O	X	X	X
7FH	7FH	--	--	Null [GM2]	-		O	O	O	O	O (All Keyboard parts)	O	O	X	O	O	O	X	O	X	X	X

● : Transmitted via panel operations and keyboard/controller performances. O : Available

About Mic/Vocal Harmony column:
The relevant parameters are received by the song part designated by the Effect's Harmony Channel Parameter or Melody Channel Parameter.

[GM1]...GM Required Parameter
[GM2]...GM Leve2 Required Parameter

XG PARAMETER CHANGE TABLE

* Not received when Receive System Exclusive Message Parameters is set to off.
 * Not transmitted when Transmit System Exclusive Message Parameters is set to off.

MIDI Parameter Change table (XG SYSTEM)

Address (H)	Size (H)	Data (H)	Parameter	Description	XG Default (H)	[MIDI]										[Song Creator]							
						Voice		MIDI Reception					MIDI Transmission				PLAY		REC				
						Regular/ Drum/ Organ Voice	Mic/ Vocal Harmony	Song	Right1 Right2 Right3 Left	Keyboard	Style	Extra	Right1 Right2 Right3 Left	M.Pad	Style	Song	Upper Lower	PLAY	REW	From panel (Right1/ Right2/ Right3/ Left)			
00	00	00	4	00-0F	MASTER TUNE	-102.4...0...+102.3[cent]	*Panel setting value	○	○	○					●				○	X	X		
		01 02 03		00-0F 00-0F 00-0F		1st bit3-0→bit15-12 2nd bit3-0→bit11-8 3rd bit3-0→bit7-4 4th bit3-0→bit3-0																	
		04	1	00-7F	MASTER VOLUME	0...127	7F	○	X	○ (Available for extra parts of a song)					○				○	○	X		
		05	1	00-7F	MASTER ATTENUATOR	0...127	00	X	X	X					○				X	X	X		
		06	1	28-58	TRANSPOSE	-24...0...+24 [semitones]	40	○	○	○ (Available for extra parts of a song)					○				○	○	X		
		7D	1	N	DRUM SETUP RESET	N:Drum setup number	-	○ (Drum Only)	X	○ (Available for extra parts of a song)					○				○	X	X		
		7E	1	00	XG SYSTEM ON	00=XG system ON	-	○	X	○ (Available for extra parts of a song)					○				○	X	○		
		7F	1	00	ALL PARAMETER RESET	00=ON	-	○	X	○ (Available for extra parts of a song)					○				○	X	X		

TOTAL SIZE 07

● : Transmitted via panel operations ○ : Available

MIDI Parameter Change table (SYSTEM INFORMATION)

Address (H)	Size (H)	Data (H)	Parameter	Description	XG Default (H)	[MIDI]										[Song Creator]			
						Voice		MIDI Reception					MIDI Transmission				PLAY		REC
						Regular/ Drum/ Organ Voice	Mic/ Vocal Harmony	Song	Right1 Right2 Right3 Left	Keyboard	Style	Extra	Right1 Right2 Right3 Left	M.Pad	Style	Song	Upper Lower	PLAY	REW
01	00	00	E	20-7F	Model Name 1	32...127(ASCII CHARACTER)							○ (Available only when receiving requests via MIDI)						
		... 0D 0E 0F		... 20-7F 1	... Model Name 14 NOT USED NOT USED	... 32...127(ASCII CHARACTER)													

TOTAL SIZE 10

Transmitted in response to Dump Request. Not received.

MIDI Parameter Change table (EFFECT1)

Address (H)	Size (H)	Data (H)	Parameter	Description	XG Default (H)	[MIDI]										[Song Creator]					
						Voice		MIDI Reception					MIDI Transmission				PLAY		REC		
						Regular/ Drum/ Organ Voice	Mic/ Vocal Harmony	Song	Right1 Right2 Right3 Left	Keyboard	Style	Extra	Right1 Right2 Right3 Left	M.Pad	Style	Song	Upper Lower	PLAY	REW	From panel (Right1/ Right2/ Right3/ Left)	
02	01	00	2	00-7F	REVERB TYPE MSB	Refer to Effect Parameter List	01 (=HALL1)	○	○	○					●				○	○	○
				00-7F	REVERB TYPE LSB	Refer to Effect Parameter List	00														
		02	1	00-7F	REVERB PARAMETER 1	Refer to Effect Parameter List	Depends on Reverb Type	○	○	○					●				○	○	○
		03	1	00-7F	REVERB PARAMETER 2	Refer to Effect Parameter List	Depends on Reverb Type	○	○	○					●				○	○	○
		04	1	00-7F	REVERB PARAMETER 3	Refer to Effect Parameter List	Depends on Reverb Type	○	○	○					●				○	○	○
		05	1	00-7F	REVERB PARAMETER 4	Refer to Effect Parameter List	Depends on Reverb Type	○	○	○					●				○	○	○
		06	1	00-7F	REVERB PARAMETER 5	Refer to Effect Parameter List	Depends on Reverb Type	○	○	○					●				○	○	○
		07	1	00-7F	REVERB PARAMETER 6	Refer to Effect Parameter List	Depends on Reverb Type	○	○	○					●				○	○	○
		08	1	00-7F	REVERB PARAMETER 7	Refer to Effect Parameter List	Depends on Reverb Type	○	○	○					●				○	○	○
		09	1	00-7F	REVERB PARAMETER 8	Refer to Effect Parameter List	Depends on Reverb Type	○	○	○					●				○	○	○
		0A	1	00-7F	REVERB PARAMETER 9	Refer to Effect Parameter List	Depends on Reverb Type	○	○	○					●				○	○	○
		0B	1	00-7F	REVERB PARAMETER 10	Refer to Effect Parameter List	Depends on Reverb Type	○	○	○					●				○	○	○
		0C	1	00-7F	REVERB RETURN	-->dB...0dB...+6dB (0...64...127)	40	○	○	○					●				○	○	○
		0D	1	01-7F	REVERB PAN	L63...C...R63	40	○	○	○					○				○	○	X

TOTAL SIZE 0E

02	01	10	1	00-7F	REVERB PARAMETER 11	Refer to Effect Parameter List	Depends on Reverb Type	○	○	○					●				○	○	○
		11	1	00-7F	REVERB PARAMETER 12	Refer to Effect Parameter List	Depends on Reverb Type	○	○	○					●				○	○	○
		12	1	00-7F	REVERB PARAMETER 13	Refer to Effect Parameter List	Depends on Reverb Type	○	○	○					●				○	○	○
		13	1	00-7F	REVERB PARAMETER 14	Refer to Effect Parameter List	Depends on Reverb Type	○	○	○					●				○	○	○
		14	1	00-7F	REVERB PARAMETER 15	Refer to Effect Parameter List	Depends on Reverb Type	○	○	○					●				○	○	○
		15	1	00-7F	REVERB PARAMETER 16	Refer to Effect Parameter List	Depends on Reverb Type	○	○	○					●				○	○	○

TOTAL SIZE 06

● : Transmitted via panel operations ○ : Available

Address (H)	Size (H)	Data (H)	Parameter	Description	XG Default (H)	[MIDI]											[Song Creator]									
						Voice		MIDI Reception				MIDI Transmission					PLAY		REC							
						Regular/ Drum/ Organ Voice	Mic/Vocal Harmony	Song	Right1 Right2 Right3 Left	Keyboard	Style	Extra	Right1 Right2 Right3 Left	M.Pad	Style	Song	Upper Lower	PLAY		REW	From panel (Right1/ Right2/ Right3/ Left)					
02	01	70	1	00-7F	VARIATION PARAMETER 11	Refer to Effect Parameter List	Depends on Variation Type	O	O																	
		71	1	00-7F	VARIATION PARAMETER 12	Refer to Effect Parameter List	Depends on Variation Type	O	O																	
		72	1	00-7F	VARIATION PARAMETER 13	Refer to Effect Parameter List	Depends on Variation Type	O	O																	
		73	1	00-7F	VARIATION PARAMETER 14	Refer to Effect Parameter List	Depends on Variation Type	O	O																	
		74	1	00-7F	VARIATION PARAMETER 15	Refer to Effect Parameter List	Depends on Variation Type	O	O																	
		75	1	00-7F	VARIATION PARAMETER 16	Refer to Effect Parameter List	Depends on Variation Type	O	O																	

TOTAL SIZE 06

● : Transmitted via panel operations O : Available

MIDI Parameter Change table (MULTI EQ)

Address (H)	Size (H)	Data (H)	Parameter	Description		[MIDI]											[Song Creator]											
						Voice		MIDI Reception				MIDI Transmission					PLAY		REC									
						Regular/ Drum/ Organ Voice	Mic/Vocal Harmony	Song	Right1 Right2 Right3 Left	Keyboard	Style	Extra	Right1 Right2 Right3 Left	M.Pad	Style	Song	Upper Lower	PLAY		REW	From panel (Right1/ Right2/ Right3/ Left)							
02	40	00	1	00-04	EQ TYPE	flat, jazz, pops, rock, classic	* The MULTI EQ Parameter can not be reset to its factory setting with XG SYSTEM ON.	O	O																			
		01	1	34-4C	EQ GAIN1	-12...0...+12[dB]		O	O									●							O	X	X	
		02	1	04-28	EQ FREQUENCY1	32...2.0k[Hz]		O	O									●							O	X	X	
		03	1	01-78	EQ Q1	0.1...12.0		O	O									●							O	X	X	
		04	1	00-01	EQ SHAPE1	shelving, peaking		O	O									●							O	X	X	
		05	1	34-4C	EQ GAIN2	-12...0...+12[dB]		O	O									●							O	X	X	
		06	1	0E-36	EQ FREQUENCY2	100...10.0k[Hz]		O	O									●							O	X	X	
		07	1	01-78	EQ Q2	0.1...12.0		O	O									●							O	X	X	
		08	1		NOT USED			-	-									-							-	-	-	
		09	1	34-4C	EQ GAIN3	-12...0...+12[dB]		O	O									●							O	X	X	
		0A	1	0E-36	EQ FREQUENCY3	100...10.0k[Hz]		O	O									●							O	X	X	
		0B	1	01-78	EQ Q3	0.1...12.0		O	O									●							O	X	X	
		0C	1		NOT USED			-	-									-							-	-	-	
		0D	1	34-4C	EQ GAIN4	-12...0...+12[dB]		O	O									●							O	X	X	
		0E	1	0E-36	EQ FREQUENCY4	100...10.0k[Hz]		O	O									●							O	X	X	
		0F	1	01-78	EQ Q4	0.1...12.0		O	O									●							O	X	X	
		10	1		NOT USED			-	-									-							-	-	-	
		11	1	34-4C	EQ GAIN5	-12...0...+12[dB]		O	O									●							O	X	X	
		12	1	1C-3A	EQ FREQUENCY5	0.5k...16.0k[Hz]		O	O									●							O	X	X	
		13	1	01-78	EQ Q5	0.1...12.0		O	O									●							O	X	X	
		14	1	00-01	EQ SHAPE5	shelving, peaking		O	O									●							O	X	X	

TOTAL SIZE 15

● : Transmitted via panel operations O : Available

MIDI Parameter Change table (EFFECT2)

Address (H)	Size (H)	Data (H)	Parameter	Description		[MIDI]											[Song Creator]												
						Voice		MIDI Reception				MIDI Transmission					PLAY		REC										
						Regular/ Drum/ Organ Voice	Mic/Vocal Harmony	Song	Right1 Right2 Right3 Left	Keyboard	Style	Extra	Right1 Right2 Right3 Left	M.Pad	Style	Song	Upper Lower	PLAY		REW	From panel (Right1/ Right2/ Right3/ Left)								
03	n	00	2	00-7F	INSERTION EFFECT TYPE MSB	Refer to Effect Parameter List	* The EFFECT2 Parameter can not be reset to its factory setting with XG SYSTEM ON.	O	O																				
		00-7F	INSERTION EFFECT TYPE LSB	Refer to Effect Parameter List		O	O																		O	O	O		
		02	1	00-7F	INSERTION EFFECT PARAMETER 1	Refer to Effect Parameter List		O	O									●							O	O	O		
		03	1	00-7F	INSERTION EFFECT PARAMETER 2	Refer to Effect Parameter List		O	O									●							O	O	O		
		04	1	00-7F	INSERTION EFFECT PARAMETER 3	Refer to Effect Parameter List		O	O									●							O	O	O		
		05	1	00-7F	INSERTION EFFECT PARAMETER 4	Refer to Effect Parameter List		O	O									●							O	O	O		
		06	1	00-7F	INSERTION EFFECT PARAMETER 5	Refer to Effect Parameter List		O	O									●							O	O	O		
		07	1	00-7F	INSERTION EFFECT PARAMETER 6	Refer to Effect Parameter List		O	O									●							O	O	O		
		08	1	00-7F	INSERTION EFFECT PARAMETER 7	Refer to Effect Parameter List		O	O									●							O	O	O		
		09	1	00-7F	INSERTION EFFECT PARAMETER 8	Refer to Effect Parameter List		O	O									●							O	O	O		
		0A	1	00-7F	INSERTION EFFECT PARAMETER 9	Refer to Effect Parameter List		O	O									●							O	O	O		
		0B	1	00-7F	INSERTION EFFECT PARAMETER 10	Refer to Effect Parameter List		O	O									●							O	O	O		
		0C	1	00-7F	INSERTION EFFECT PART NUMBER	Reception : Part1...16(0...15) Transmission : Part1...16(0...15) AD(64) OFF(127)		O	O									●							O	O	O		
		0D	1	00-7F	MW INSERTION CONTROL DEPTH	-64...0...+63		O	O																O	O	X		
		0E	1	00-7F	BEND INSERTION CONTROL DEPTH	-64...0...+63		O	O																O	O	X		
		0F	1	00-7F	CAT INSERTION CONTROL DEPTH	-64...0...+63		O	O																O	O	X		
		10	1	00-7F	AC1 INSERTION CONTROL DEPTH	-64...0...+63		O	O																O	O	X		
		11	1	00-7F	AC2 INSERTION CONTROL DEPTH	-64...0...+63		O	O																O	O	X		

TOTAL SIZE 12

Address (H)	Size (H)	Data (H)	Parameter	Description		[MIDI]										[Song Creator]							
						Voice		MIDI Reception				MIDI Transmission				PLAY		REC					
						Regular/Drum/Organ Voice	Mic/Vocal Harmony	Song	Right1 Right2 Right3 Left	Keyboard	Style	Extra	Right1 Right2 Right3 Left	M.Pad	Style	Song	Upper Lower	PLAY	REW	From panel (Right1/Right2/Right3/Left)			
	20	1	00-7F	INSERTION EFFECT PARAMETER 11	Refer to Effect Parameter List	* The EFFECT2 Parameter can not be reset to its factory setting with XG SYSTEM ON.	○	○		○							●			○	○	○	
	21	1	00-7F	INSERTION EFFECT PARAMETER 12	Refer to Effect Parameter List		○	○		○								●			○	○	○
	22	1	00-7F	INSERTION EFFECT PARAMETER 13	Refer to Effect Parameter List		○	○		○								●			○	○	○
	23	1	00-7F	INSERTION EFFECT PARAMETER 14	Refer to Effect Parameter List		○	○		○								●			○	○	○
	24	1	00-7F	INSERTION EFFECT PARAMETER 15	Refer to Effect Parameter List		○	○		○								●			○	○	○
	25	1	00-7F	INSERTION EFFECT PARAMETER 16	Refer to Effect Parameter List		○	○		○								●			○	○	○

TOTAL SIZE 6

	30	2	00-7F	INSERTION EFFECT PARAMETER 1 MSB	Refer to Effect Parameter List	* The EFFECT2 Parameter can not be reset to its factory setting with XG SYSTEM ON.	○	○		○									●			○	○	○	
			00-7F	INSERTION EFFECT PARAMETER 1 LSB	Refer to Effect Parameter List		○	○		○										●			○	○	○
	32	2	00-7F	INSERTION EFFECT PARAMETER 2 MSB	Refer to Effect Parameter List		○	○		○										●			○	○	○
			00-7F	INSERTION EFFECT PARAMETER 2 LSB	Refer to Effect Parameter List		○	○		○										●			○	○	○
	34	2	00-7F	INSERTION EFFECT PARAMETER 3 MSB	Refer to Effect Parameter List		○	○		○										●			○	○	○
			00-7F	INSERTION EFFECT PARAMETER 3 LSB	Refer to Effect Parameter List		○	○		○										●			○	○	○
	36	2	00-7F	INSERTION EFFECT PARAMETER 4 MSB	Refer to Effect Parameter List		○	○		○										●			○	○	○
			00-7F	INSERTION EFFECT PARAMETER 4 LSB	Refer to Effect Parameter List		○	○		○										●			○	○	○
	38	2	00-7F	INSERTION EFFECT PARAMETER 5 MSB	Refer to Effect Parameter List		○	○		○										●			○	○	○
			00-7F	INSERTION EFFECT PARAMETER 5 LSB	Refer to Effect Parameter List		○	○		○										●			○	○	○
	3A	2	00-7F	INSERTION EFFECT PARAMETER 6 MSB	Refer to Effect Parameter List		○	○		○										●			○	○	○
			00-7F	INSERTION EFFECT PARAMETER 6 LSB	Refer to Effect Parameter List		○	○		○										●			○	○	○
	3C	2	00-7F	INSERTION EFFECT PARAMETER 7 MSB	Refer to Effect Parameter List		○	○		○										●			○	○	○
			00-7F	INSERTION EFFECT PARAMETER 7 LSB	Refer to Effect Parameter List		○	○		○										●			○	○	○
	3E	2	00-7F	INSERTION EFFECT PARAMETER 8 MSB	Refer to Effect Parameter List		○	○		○										●			○	○	○
			00-7F	INSERTION EFFECT PARAMETER 8 LSB	Refer to Effect Parameter List		○	○		○										●			○	○	○
	40	2	00-7F	INSERTION EFFECT PARAMETER 9 MSB	Refer to Effect Parameter List	○	○		○										●			○	○	○	
			00-7F	INSERTION EFFECT PARAMETER 9 LSB	Refer to Effect Parameter List	○	○		○										●			○	○	○	
	42	2	00-7F	INSERTION EFFECT PARAMETER 10 MSB	Refer to Effect Parameter List	○	○		○										●			○	○	○	
			00-7F	INSERTION EFFECT PARAMETER 10 LSB	Refer to Effect Parameter List	○	○		○										●			○	○	○	

TOTAL SIZE 14

● : Transmitted via panel operations ○ : Available

The second byte of the address is considered as an Insertion effect number.

n : insertion effect number (n=0-5)

For effect types that do not require MSB, the Parameters for Address 02-0B will be received and the Parameters for Address 30-42 will not be received.

For effect types that require MSB, the Parameters for Address 30-42 will be received and the Parameters for Address 02-0B will not be received.

Type MSB of the effect types that require Parameter MSB are: 5, 6, 7, 8, 95, 96, 97, 98, 104.

When Bulk Dumps that include Effect Type data are transmitted, the Parameters for Address 02-0B will always be transmitted. But, effects that require MSB,

when the bulk dump is received the Parameters for Address 02-0B will not be received.

MIDI Parameter Change table (SPECIAL EFFECT)

Address (H)	Size (H)	Data (H)	Parameter	Description		[MIDI]										[Song Creator]									
						Voice		MIDI Reception				MIDI Transmission				PLAY		REC							
						Regular/Drum/Organ Voice	Mic/Vocal Harmony	Song	Right1 Right2 Right3 Left	Keyboard	Style	Extra	Right1 Right2 Right3 Left	M.Pad	Style	Song	Upper Lower	PLAY	REW	From panel (Right1/Right2/Right3/Left)					
04	00	00	2	00-7F	INSERTION EFFECT TYPE MSB	* The SPECIAL EFFECT Parameter can not be reset to its factory setting with XG SYSTEM ON.	X	○		○									●			○	○	X	
			00-7F	INSERTION EFFECT TYPE LSB	X		○		○											●			○	○	X
	02	1	00-7F	INSERTION EFFECT PARAMETER 1 Harmony Mode	Off(0), Auto(1)		X	○		○										●			○	○	X
	03	1	00-7F	INSERTION EFFECT PARAMETER 2 Harmony Gender Type	Off(0), Unison(1), Male(2), Female(3)		X	○		○										●			○	○	X
	04	1	00-7F	INSERTION EFFECT PARAMETER 3 Lead Gender Type	-64...0...+63(0...127)		X	○		○										●			○	○	X
	05	1	00-7F	INSERTION EFFECT PARAMETER 4 Lead Gender Depth	Free(0), Correct(1)		X	○		○										●			○	○	X
	06	1	00-7F	INSERTION EFFECT PARAMETER 5 Lead Pitch Correction	0...12(0...12)		X	○		○										●			○	○	X
	07	1	00-7F	INSERTION EFFECT PARAMETER 6 Auto Upper Gender Threshold			X	○		○										●			○	○	X

Address (H)	Size (H)	Data (H)	Parameter	Description	XG Default (H)	[MIDI]											[Song Creator]			
						Voice			MIDI Reception				MIDI Transmission				PLAY		REC	
						Regular/Drum/Organ Voice	Mic/Vocal Harmony	Song	Right1 Right2 Right3 Left	Keyboard	Style	Extra	Right1 Right2 Right3 Left	M.Pad	Style	Song	Upper Lower	PLAY	REW	From panel (Right1/Right2/Right3/Left)
	08	1	00-7F	INSERTION EFFECT PARAMETER 7 Auto Lower Gender Threshold	0...12(0...12)		X	O		O					●			O	O	X
	09	1	00-7F	INSERTION EFFECT PARAMETER 8 Upper Gender Depth	-64...0+63(0...127)	* The SPECIAL EFFECT Parameter can not be reset to its factory setting with XG SYSTEM ON.	X	O		O					●			O	O	X
	0A	1	00-7F	INSERTION EFFECT PARAMETER 9 Lower Gender Depth	-64...0...+63(0...127)		X	O		O					●			O	O	X
	0B	1	00-7F	INSERTION EFFECT PARAMETER 10	L63>H...L=H...L<H63 (1...64...127)		X	O		O					●			O	O	X
	0C	1	00-7F	INSERTION EFFECT PART NUMBER	AD(64), OFF(0...63, 65...127)		X	O		O					●			O	O	O
	0D	1	00-7F	MW INSERTION CONTROL DEPTH	-64...0...+63		X	X		X					X			X	X	X
	0E	1	00-7F	BEND INSERTION CONTROL DEPTH	-64...0...+63		X	X		X					X			X	X	X
	0F	1	00-7F	CAT INSERTION CONTROL DEPTH	-64...0...+63		X	X		X					X			X	X	X
	10	1	00-7F	AC1 INSERTION CONTROL DEPTH	-64...0...+63		X	X		X					X			X	X	X
	11	1	00-7F	AC2 INSERTION CONTROL DEPTH	-64...0...+63		X	X		X					X			X	X	X

TOTAL SIZE 12

	14	1	00-7F	UNIQUE INSERTION EFFECT EXTERNAL CONTROL CH1 (HARMONY CHANNEL)	1...16(0...15), OFF(127)		X	O		O					●			O	O	X
	15	1	00-7F	UNIQUE INSERTION EFFECT EXTERNAL CONTROL CH1 (MELODY CHANNEL)	1...16(0...15), OFF(127)		X	O		O					O			O	O	X

TOTAL SIZE 2

	20	1	00-7F	INSERTION EFFECT PARAMETER 11 Vibrato Depth	0...100cemt(0...127)		X	O		O					●			O	O	X
	21	1	00-7F	INSERTION EFFECT PARAMETER 12 Vibrato Rate	0Hz(0),0.1...12.7Hz(1...127)		X	O		O					●			O	O	X
	22	1	00-7F	INSERTION EFFECT PARAMETER 13 Vibrato Delay	0..254sec(0...127)		X	O		O					●			O	O	X
	23	1	00-7F	INSERTION EFFECT PARAMETER 14			X	X		X					X			X	X	X
	24	1	00-7F	INSERTION EFFECT PARAMETER 15			X	X		X					X			X	X	X
	25	1	00-7F	INSERTION EFFECT PARAMETER 16			X	X		X					X			X	X	X

TOTAL SIZE 6

● : Transmitted via panel operations ○ : Available

MIDI Parameter Change table (MULTI PART)

Address (H)	Size (H)	Data (H)	Parameter	Description	XG Default (H)	[MIDI]											[Song Creator]							
						Voice			MIDI Reception				MIDI Transmission				PLAY		REC					
						Regular/Drum/Organ Voice	Mic/Vocal Harmony	Song	Right1 Right2 Right3 Left	Keyboard	Style	Extra	Right1 Right2 Right3 Left	M.Pad	Style	Song	Upper Lower	PLAY	REW	From panel (Right1/Right2/Right3/Left)				
8	nn	00	1	00-20	ELEMENT RESERVE	0...32			-	-	-	-	-	-	-	-	-	-	-	-	-	-	-	-
		01	1	00-7F	BANK SELECT MSB	0...127	part10=7F, other parts=00	O	X	O	O	X	O	O	X	X	X	O	X	O	O	O	X	
		02	1	00-7F	BANK SELECT LSB	0...127	00	O	X	O	O	X	O	O	X	X	X	O	X	O	O	O	X	
		03	1	00-7F	PROGRAM NUMBER	1...128	00	O	X	O	O	X	O	O	X	X	X	O	X	O	O	O	X	
		04	1	00-0F,7F	Rcv CHANNEL	1...16, OFF	Part No.	O	X	O	X	X	X	X	X	X	X	O	X	O	X	X	X	
		05	1	00-01	MONO/POLY MODE	MONO, POLY	01	O	X	O	X	X	X	X	X	X	O	X	O	X	X	X		
		06	1	00-02	SAME NOTE NUMBER KEY ON ASSIGN	SINGLE, MULTI, INST (for Drum)	01	O	X	O	X	X	O	X	X	X	X	O	X	O	X	X		
		07	1	00-03	PART MODE	NORMAL, DRUM, DRUMS1..2	part10=02, other parts=00	O	X	O	X	X	X	●	X	●	●	X	O	X	O	O	X	
		08	1	28-58	NOTE SHIFT	-24...0...+24[semitones]	40	O	X	O	O	X	O	O	X	X	X	O	X	O	O	X		
		09	2	00-0F 0A	DETUNE	-12.8...0...+12.7[Hz] 1st bit3-0→bit7-4 2nd bit3-0→bit3-0	08 00	O	X	O	O	X	O	O	X	X	X	O	X	O	X	X	X	
		0B	1	00-7F	VOLUME	0...127	64	O	X	O	O	X	O	O	X	X	X	O	X	O	O	X		
		0C	1	00-7F	VELOCITY SENSE DEPTH	0...127	40	O	X	O	O	X	X	O	●	O	X	O	X	O	O	O	O	
		0D	1	00-7F	VELOCITY SENSE OFFSET	0...127	40	O	X	O	O	X	X	O	●	O	X	O	X	O	O	O	O	
		0E	1	00-7F	PAN	RND_L63...C...R63	40	O	X	O	O	X	O	O	X	X	X	O	X	O	O	O	X	
		0F	1	00-7F	NOTE LIMIT LOW	C-2...G8	00	O	X	O	X	X	X	X	X	X	X	O	X	O	X	X	X	
		10	1	00-7F	NOTE LIMIT HIGH	C-2...G8	7F	O	X	O	X	X	X	X	X	X	X	O	X	O	X	X	X	
		11	1	00-7F	DRY LEVEL	0...127	7F	O	X	O	O	X	O	O	X	O	●	●	X	O	O	O	O	
		12	1	00-7F	CHORUS SEND	0...127	00	O	X	O	O	X	O	O	X	X	X	O	X	O	O	O	X	
		13	1	00-7F	REVERB SEND	0...127	28	O	X	O	O	X	O	O	X	X	X	O	X	O	O	O	X	
		14	1	00-7F	VARIATION SEND	0...127	00	O	X	O	O	X	O	O	X	X	X	O	X	O	O	O	X	
		15	1	00-7F	VIBRATO RATE	-64...0...+63	40	O	X	O	O	X	O	O	X	X	X	O	X	O	O	O	X	
		16	1	00-7F	VIBRATO DEPTH	-64...0...+63	40	O	X	O	O	X	O	O	X	X	X	O	X	O	O	O	X	
		17	1	00-7F	VIBRATO DELAY	-64...0...+63	40	O	X	O	O	X	O	O	X	X	X	O	X	O	O	O	X	
		18	1	00-7F	FILTER CUTOFF FREQUENCY	-64...0...+63	40	O	X	O	O	X	O	O	X	X	X	O	X	O	O	O	X	
		19	1	00-7F	FILTER RESONANCE	-64...0...+63	40	O	X	O	O	X	O	O	X	X	X	O	X	O	O	O	X	
		1A	1	00-7F	EG ATTACK TIME	-64...0...+63	40	O	X	O	O	X	O	O	X	X	X	O	X	O	O	O	X	
		1B	1	00-7F	EG DECAY TIME	-64...0...+63	40	O	X	O	O	X	O	O	X	X	X	O	X	O	O	O	X	
		1C	1	00-7F	EG RELEASE TIME	-64...0...+63	40	O	X	O	O	X	O	O	X	X	X	O	X	O	O	O	X	
		1D	1	28-58	MW PITCH CONTROL	-24...0...+24[semitones]	40	O	X	O	O	X	X	O	X	X	X	O	X	O	X	X	X	

Address (H)	Size (H)	Data (H)	Parameter	Description	XG Default (H)	[MIDI]										[Song Creator]			
						Voice		MIDI Reception				MIDI Transmission				PLAY		REC	
						Regular/Drum/Organ Voice	Mic/Vocal Harmony	Song	Right1 Right2 Right3 Left	Keyboard	Style	Extra	Right1 Right2 Right3 Left	M.Pad	Style	Song	Upper Lower	PLAY	REW
70	1		NOT USED		-	-	-	-	-	-	-	-	-	-	-	-	-	-	-
71	1		NOT USED		-	-	-	-	-	-	-	-	-	-	-	-	-	-	-
72	1	00-7F	EQ BASS GAIN	-12dB...+12dB	40	O	X	O	O	X	O	O	●	●	●	●	X	O	O
73	1	00-7F	EQ TREBLE GAIN	-12dB...+12dB	40	O	X	O	O	X	O	O	●	●	●	●	X	O	O

TOTAL SIZE 04

74	1		NOT USED		-	-	-	-	-	-	-	-	-	-	-	-	-	-	-
75	1		NOT USED		-	-	-	-	-	-	-	-	-	-	-	-	-	-	-
76	1	04-2B	EQ BASS FREQUENCY	32...2.0k[Hz]	0C	O	X	O	O	X	X	O	●	O	O	O	X	O	O
77	1	1C-3A	EQ TREBLE FREQUENCY	500...16.0k[Hz]	36	O	X	O	O	X	X	O	●	O	O	O	X	O	O
78	1		NOT USED		-	-	-	-	-	-	-	-	-	-	-	-	-	-	-
79	1		NOT USED		-	-	-	-	-	-	-	-	-	-	-	-	-	-	-
7A	1		NOT USED		-	-	-	-	-	-	-	-	-	-	-	-	-	-	-
7B	1		NOT USED		-	-	-	-	-	-	-	-	-	-	-	-	-	-	-
7C	1		NOT USED		-	-	-	-	-	-	-	-	-	-	-	-	-	-	-
7D	1		NOT USED		-	-	-	-	-	-	-	-	-	-	-	-	-	-	-
7E	1		NOT USED		-	-	-	-	-	-	-	-	-	-	-	-	-	-	-
7F	1		NOT USED		-	-	-	-	-	-	-	-	-	-	-	-	-	-	-

TOTAL SIZE 0C

0A	nn	40	1	00-7F	MW OFFSET LEVEL CONTROL	-100 - 100[%]	40	O	-	O	O	X	X	O	●	O	X	O	X	O	O	O
		41	1	00-7F	BEND OFFSET LEVEL CONTROL	-100 - 100[%]	40	O	-	O	X	X	X	X	X	X	X	O	X	O	O	X
		42	1	00-7F	CAT OFFSET LEVEL CONTROL	-100 - 100[%]	40	O	-	O	O	X	X	O	X	O	X	O	X	O	O	X
		43	1	00-7F	PAT OFFSET LEVEL CONTROL	-100 - 100[%]	40	O	-	O	X	X	X	X	X	X	X	O	X	O	O	X
		44	1	00-7F	AC1 OFFSET LEVEL CONTROL	-100 - 100[%]	40	O	-	O	X	X	X	X	X	X	X	O	X	O	O	X
		45	1	00-7F	AC2 OFFSET LEVEL CONTROL	-100 - 100[%]	40	O	-	O	X	X	X	X	X	X	X	O	X	O	O	X

TOTAL SIZE 06

● : Transmitted via panel operations O : Available

nn : PART NUMBER

If there is a Drum Voice assigned to the part, the following parameters are ineffective.

- BANK_SELECT_LSB
- PORTAMENTO
- MONO/POLY
- SCALE_TUNING
- POLY_AFTER_TOUCH
- PITCH_EG

MIDI Parameter Change table (A/D PART)

Address (H)	Size (H)	Data (H)	Parameter	Description		[MIDI]										[Song Creator]		
						Voice		MIDI Reception				MIDI Transmission				PLAY		REC
						Regular/Drum/Organ Voice	Mic/Vocal Harmony	Song	Right1 Right2 Right3 Left	Keyboard	Style	Extra	Right1 Right2 Right3 Left	M.Pad	Style	Song	Upper Lower	PLAY
10	0n	00	1	00-01	INPUT GAIN	MIC, LINE		X	X		X				X		X	X
		01	1	00-7F	BANK SELECT MSB	0...127		X	X		X			X		X	X	X
		02	1	00-7F	BANK SELECT LSB	0...127		X	X		X			X		X	X	X
		03	1	00-7F	PROGRAM NUMBER	1...128		X	X		X			X		X	X	X
		04	1	00-0F,7F	Rcv CHANNEL	1...16,OFF		X	O		O			O		O	X	X
		05	1		NOT USED			-	-		-			-		-	-	-
		06	1		NOT USED			-	-		-			-		-	-	-
		07	1		NOT USED			-	-		-			-		-	-	-
		08	1		NOT USED			-	-		-			-		-	-	-
		09	1		NOT USED			-	-		-			-		-	-	-
		0A	1		NOT USED			-	-		-			-		-	-	-
		0B	1	00-7F	VOLUME	0...127		X	O		O			●		O	X	X
		0C	1		NOT USED			-	-		-			-		-	-	-
		0D	1		NOT USED			-	-		-			-		-	-	-
		0E	1	01-7F	PAN	L63...C...R63		X	O		O			●		O	X	X
		0F	1		NOT USED			-	-		-			-		-	-	-
		10	1		NOT USED			-	-		-			-		-	-	-
		11	1	00-7F	DRY LEVEL	0...127		X	O		O			●		O	X	X
		12	1	00-7F	CHORUS SEND	0...127		X	O		O			●		O	X	X
		13	1	00-7F	REVERB SEND	0...127		X	O		O			●		O	X	X
		14	1	00-7F	VARIATION SEND	0...127		X	O		O			●		O	X	X

TOTAL SIZE 15

● : Transmitted via panel operations O : Available

n : A/D Part Number (0)

MIDI Parameter Change table (DRUM SETUP)

Address (H)	Size (H)	Data (H)	Parameter	Description	XG Default (H)	[MIDI]										[Song Creator]				
						Voice		MIDI Reception				MIDI Transmission				PLAY	REW	REC		
						Regular/ Drum/ Organ Voice	Mic/Vocal Harmony	Song	Right1 Right2 Right3 Left	Keyboard	Style	Extra	Right1 Right2 Right3 Left	M.Pad	Style	Song	Upper Lower			From panel (Right1/ Right2/ Right3/ Left)
3n	rr	00	1	00-7F	PITCH COARSE	-64...0...+63	40	O(Drum Only)	X	O(Available only for song parts)				O				O	X	X
		01	1	00-7F	PITCH FINE	-64...0...+63[cent]	40	O(Drum Only)	X	O(Available only for song parts)				O				O	X	X
		02	1	00-7F	LEVEL	0...127	Depends on the note	O(Drum Only)	X	O(Available only for song parts)				O				O	X	X
		03	1	00-7F	ALTERNATE GROUP	OFF, 1...127	Depends on the note	O(Drum Only)	X	O(Available only for song parts)				O				O	X	X
		04	1	00-7F	PAN	RND, L63...C...R63	Depends on the note	O(Drum Only)	X	O(Available only for song parts)				O				O	X	X
		05	1	00-7F	REVERB SEND	0...127	Depends on the note	O(Drum Only)	X	O(Available only for song parts)				O				O	X	X
		06	1	00-7F	CHORUS SEND	0...127	Depends on the note	O(Drum Only)	X	O(Available only for song parts)				O				O	X	X
		07	1	00-7F	VARIATION SEND	0...127	7F	O(Drum Only)	X	O(Available only for song parts)				O				O	X	X
		08	1	00-01	KEY ASSIGN	SINGLE, MULTI	00	O(Drum Only)	X	O(Available only for song parts)				O				O	X	X
		09	1	00-01	Rcv NOTE OFF	OFF, ON	Depends on the note	O(Drum Only)	X	O(Available only for song parts)				O				O	X	X
		0A	1	00-01	Rcv NOTE ON	OFF, ON	01	O(Drum Only)	X	O(Available only for song parts)				O				O	X	X
		0B	1	00-7F	LOW PASS FILTER CUTOFF FREQUENCY	-64...0...+63	40	O(Drum Only)	X	O(Available only for song parts)				O				O	X	X
		0C	1	00-7F	LOW PASS FILTER RESONANCE	-64...0...+63	40	O(Drum Only)	X	O(Available only for song parts)				O				O	X	X
		0D	1	00-7F	EG ATTACK RATE	-64...0...+63	40	O(Drum Only)	X	O(Available only for song parts)				O				O	X	X
		0E	1	00-7F	EG DECAY1 RATE	-64...0...+63	40	O(Drum Only)	X	O(Available only for song parts)				O				O	X	X
		0F	1	00-7F	EG DECAY2 RATE	-64...0...+63	40	O(Drum Only)	X	O(Available only for song parts)				O				O	X	X

TOTAL SIZE 10

Address (H)	Size (H)	Data (H)	Parameter	Description	XG Default (H)	[MIDI]										[Song Creator]				
						Voice		MIDI Reception				MIDI Transmission				PLAY	REW	REC		
						Regular/ Drum/ Organ Voice	Mic/Vocal Harmony	Song	Right1 Right2 Right3 Left	Keyboard	Style	Extra	Right1 Right2 Right3 Left	M.Pad	Style	Song	Upper Lower			From panel (Right1/ Right2/ Right3/ Left)
		20	1	00-7F	EQ BASS GAIN	-12...+12[dB]	40	X	X	X				O				X	X	X
		21	1	00-7F	EQ TREBLE GAIN	-12...+12[dB]	40	X	X	X				O				X	X	X
		22	1		NOT USED	-	-	-	-	-				-				-	-	-
		23	1		NOT USED	-	-	-	-	-				-				-	-	-
		24	1	04-28	EQ BASS FREQUENCY	32...2.0k[Hz]	0C	X	X	X				O				X	X	X
		25	1	1C-3A	EQ TREBLE FREQUENCY	500...16.0k[Hz]	36	X	X	X				O				X	X	X
		26	1		NOT USED	-	-	-	-	-				-				-	-	-
		27	1		NOT USED	-	-	-	-	-				-				-	-	-
		28	1		NOT USED	-	-	-	-	-				-				-	-	-
		29	1		NOT USED	-	-	-	-	-				-				-	-	-
		2A	1		NOT USED	-	-	-	-	-				-				-	-	-
		2B	1		NOT USED	-	-	-	-	-				-				-	-	-
		2C	1		NOT USED	-	-	-	-	-				-				-	-	-
		2D	1		NOT USED	-	-	-	-	-				-				-	-	-

TOTAL SIZE 0E

n : Drum Setup Number (0-1)
rr : note number(0D-5B)

In the following cases, the instrument will initialize all Drum Setups.
 XG SYSTEM ON received
 GM SYSTEM ON received
 GM LEVEL2 SYSTEM ON received
 GS RESET received
 DRUM SETUP RESET received (only when in XG mode)

[Note]

When a part to which a Drum Setup is assigned receives a program change, the assigned Drum Setup will be initialized.
 If the same Drum Setup is assigned to two or more parts, changes in Drum Setup parameters (including program changes) will apply to all parts to which it is assigned.

SYSTEM EXCLUSIVE MESSAGES (1)

[GM1]...GM Required Parameter
 [GM2]...GM Level 2 Required Parameter

Not received when Receive System Exclusive Message Parameters is set to off.
 Not transmitted when Transmit System Exclusive Message Parameters is set to off.

System Exclusive Messages (Universal Real Time Messages)

MIDI Event	Data Format	[MIDI]													[Song Creator]			
		Voice		MIDI Reception				MIDI Transmission							PLAY	REC		
		Regular/ Drum/ Organ Voice	Mic/Vocal Harmony	Song	Right1 Right2 Right3 Left	Keyboard	Style	Extra	Right1 Right2 Right3 Left	M.Pad	Style	Song	Upper Lower	PLAY	REW	From panel operations		
Master Volume [GM2]	F0 7F XN 04 01 SS TT F7 11110000 F0 = Exclusive status 01111111 7F = Universal Real Time 0xxxxxxx XN = When N is received N=0-F, whichever is received. X=ignored 00000100 04 = Sub-ID #1=Device Control Message 00000001 01 = Sub-ID #2=Master Volume 0sssssss SS = Volume LSB 0ttttttt TT = Volume MSB 11110111 F7 = End of Exclusive	0	X		0 (Available for extra parts of a song)				0							0	0	X
Master Fine Tuning [GM2]	F0 7F XN 04 03 SS TT F7 11110000 F0 = Exclusive status 01111111 7F = Universal Real Time 0xxxxxxx XN = When N is received N=0-F, whichever is received. X=ignored 00000100 04 = Sub-ID #1=Device Control Message 00000011 03 = Sub-ID #2=Master Fine Tuning 0sssssss SS = Fine Tuning LSB 0ttttttt TT = Fine Tuning MSB 11110111 F7 = End of Exclusive	0	X		0 (Available for extra parts of a song)				0							0	X	X
Master Coarse Tuning [GM2]	F0 7F XN 04 04 SS TT F7 11110000 F0 = Exclusive status 01111111 7F = Universal Real Time 0xxxxxxx XN = When N is received N=0-F, whichever is received. X=ignored 00000100 04 = Sub-ID #1=Device Control Message 00000100 04 = Sub-ID #2=Master Coarse Tuning 00000000 00 0ttttttt TT = Coarse Tuning MSB 11110111 F7 = End of Exclusive	0	X		0 (Available for extra parts of a song)				0							0	X	X
Reverb Parameter [GM2]	F0 7F XN 04 05 01 01 01 01 PP VV ... F7 11110000 F0 = Exclusive status 01111111 7F = Universal Real Time 0xxxxxxx XN = When N is received N=0-F, whichever is received. X=ignored 00000100 04 = Sub-ID #1=Device Control Message 00000101 05 = Sub-ID #2=Global Parameter Control 00000001 01 = Slot path length = 1 00000001 01 = Parameter ID width = 1 00000001 01 = Value width = 1 00000001 01 = Slot path MSB = 1 00000001 01 = Slot path LSB = 1 (Reverb) 0ppppppp PP = Parameter to be controlled. 0vvvvvvv VV = Value for the Parameter. : 11110111 F7 = End of Exclusive Parameter(pp) Value(vv) Display ----- pp=0 Reverb Type 0..8 0:RoomS 1:RoomM 2:RoomL 3:HallM 4:HallL(default) 8:GM Plate pp=1 Reverb Time 0..127 0..11.0s	0	0		0				0							0	0	X
Chorus Parameter [GM2]	F0 7F XN 04 05 01 01 01 02 PP VV ... F7 11110000 F0 = Exclusive status 01111111 7F = Universal Real Time 0xxxxxxx XN = When N is received N=0-F, whichever is received. X=ignored 00000100 04 = Sub-ID #1=Device Control Message 00000101 05 = Sub-ID #2=Global Parameter Control 00000001 01 = Slot path length = 1 00000001 01 = Parameter ID width = 1 00000001 01 = Value width = 1 00000001 01 = Slot path MSB = 1 00000010 02 = Slot path LSB = 2 (Chorus) 0ppppppp PP = Parameter to be controlled. 0vvvvvvv VV = Value for the Parameter. : 11110111 F7 = End of Exclusive Parameter(pp) Value(vv) Display ----- pp=0 Chorus Type 0..5 0:GM Chorus1 1:GM Chorus2 2:GM Chorus3 (default) 3:GM Chorus4 4:FB Chorus 5:GM Flanger pp=1 Mod Rate 0..127 0..15.5Hz pp=2 Mod Depth 0..127 pp=3 Feedback 0..127 pp=4 Send to Reverb 0..127	0	0		0				0							0	0	X

MIDI Event	Data Format	[MIDI]											[Song Creator]																														
		Voice		MIDI Reception				MIDI Transmission					PLAY		REC																												
		Regular/ Drum/ Organ Voice	Mic/Vocal Harmony	Song	Keyboard	Style	Extra	Right1 Right2 Right3 Left	M. Pad	Style	Song	Upper Lower	PLAY	REW	From panel operations																												
Channel Pressure (Aftertouch) [GM2]	<p>F0 7F XN 09 01 0M PP RR ... F7</p> <p>11110000 F0 = Exclusive status 01111111 7F = Universal Real Time 0xxxxnnn XN = When N is received N=0-F, whichever is received. X=ignored 00001001 09 = Sub-ID #1=Controller Destination Setting 00000001 01 = Sub-ID #2=Controller Type:01(Channel Pressure) 0000mmmm 0M = MIDI Channel (00-0F) 0ppppppp PP = Controlled Parameter 0rrrrrrr RR = Data : : 11110111 F7 = End of Exclusive</p> <p>Make sure to set both the controlled parameter and the range. Parameters not set will be restored to their default values.</p> <table border="1"> <thead> <tr> <th>Control Parameter(pp)</th> <th>Data(RR)</th> <th>Description</th> <th>Default Value</th> </tr> </thead> <tbody> <tr> <td>pp=00 Pitch Control</td> <td>28H-58H</td> <td>-24...0...+24semitones</td> <td>40H</td> </tr> <tr> <td>pp=01 Filter Cutoff Control</td> <td>00H-7FH</td> <td>-9600...0...+9450cents</td> <td>40H</td> </tr> <tr> <td>pp=02 Amplitude Control</td> <td>00H-7FH</td> <td>-100...0...+100%</td> <td>40H</td> </tr> <tr> <td>pp=03 LFO Pitch Depth</td> <td>00H-7FH</td> <td>0...127</td> <td>00H</td> </tr> <tr> <td>pp=04 LFO Filter Depth</td> <td>00H-7FH</td> <td>0...127</td> <td>00H</td> </tr> <tr> <td>pp=05 LFO Amplitude Depth</td> <td>00H-7FH</td> <td>0...127</td> <td>00H</td> </tr> </tbody> </table>	Control Parameter(pp)	Data(RR)	Description	Default Value	pp=00 Pitch Control	28H-58H	-24...0...+24semitones	40H	pp=01 Filter Cutoff Control	00H-7FH	-9600...0...+9450cents	40H	pp=02 Amplitude Control	00H-7FH	-100...0...+100%	40H	pp=03 LFO Pitch Depth	00H-7FH	0...127	00H	pp=04 LFO Filter Depth	00H-7FH	0...127	00H	pp=05 LFO Amplitude Depth	00H-7FH	0...127	00H	0	X	0	X	X	X	X	X	X	0	X	0	X	X
Control Parameter(pp)	Data(RR)	Description	Default Value																																								
pp=00 Pitch Control	28H-58H	-24...0...+24semitones	40H																																								
pp=01 Filter Cutoff Control	00H-7FH	-9600...0...+9450cents	40H																																								
pp=02 Amplitude Control	00H-7FH	-100...0...+100%	40H																																								
pp=03 LFO Pitch Depth	00H-7FH	0...127	00H																																								
pp=04 LFO Filter Depth	00H-7FH	0...127	00H																																								
pp=05 LFO Amplitude Depth	00H-7FH	0...127	00H																																								
Controller (Control Change) [GM2]	<p>F0 7F XN 09 03 0M CC PP RR ... F7</p> <p>11110000 F0 = Exclusive status 01111111 7F = Universal Real Time 0xxxxnnn XN = When N is received N=0-F, whichever is received. X=ignored 00001001 09 = Sub-ID #1=Controller Destination Setting 00000011 03 = Sub-ID #2=Controller Type:03(Control Change) 0000mmmm 0M = MIDI Channel (00-0F) 0ccccccc CC = Controller Number (01H-1FH, 40H-5FH) 0ppppppp PP = Controlled Parameter 0rrrrrrr RR = Range : : 11110111 F7 = End of Exclusive</p> <p>Make sure to set both the controlled parameter and the range. Parameters not set will be restored to their default values.</p> <table border="1"> <thead> <tr> <th>Control Parameter(pp)</th> <th>Data(RR)</th> <th>Description</th> <th>Default Value</th> </tr> </thead> <tbody> <tr> <td>pp=00 Pitch Control</td> <td>28H-58H</td> <td>-24...0...+24semitones</td> <td>40H</td> </tr> <tr> <td>pp=01 Filter Cutoff Control</td> <td>00H-7FH</td> <td>-9600...0...+9450cents</td> <td>40H</td> </tr> <tr> <td>pp=02 Amplitude Control</td> <td>00H-7FH</td> <td>-100...0...+100%</td> <td>40H</td> </tr> <tr> <td>pp=03 LFO Pitch Depth</td> <td>00H-7FH</td> <td>0...127</td> <td>00H</td> </tr> <tr> <td>pp=04 LFO Filter Depth</td> <td>00H-7FH</td> <td>0...127</td> <td>00H</td> </tr> <tr> <td>pp=05 LFO Amplitude Depth</td> <td>00H-7FH</td> <td>0...127</td> <td>00H</td> </tr> </tbody> </table>	Control Parameter(pp)	Data(RR)	Description	Default Value	pp=00 Pitch Control	28H-58H	-24...0...+24semitones	40H	pp=01 Filter Cutoff Control	00H-7FH	-9600...0...+9450cents	40H	pp=02 Amplitude Control	00H-7FH	-100...0...+100%	40H	pp=03 LFO Pitch Depth	00H-7FH	0...127	00H	pp=04 LFO Filter Depth	00H-7FH	0...127	00H	pp=05 LFO Amplitude Depth	00H-7FH	0...127	00H	0	X	0	X	X	X	X	X	X	0	X	0	X	X
Control Parameter(pp)	Data(RR)	Description	Default Value																																								
pp=00 Pitch Control	28H-58H	-24...0...+24semitones	40H																																								
pp=01 Filter Cutoff Control	00H-7FH	-9600...0...+9450cents	40H																																								
pp=02 Amplitude Control	00H-7FH	-100...0...+100%	40H																																								
pp=03 LFO Pitch Depth	00H-7FH	0...127	00H																																								
pp=04 LFO Filter Depth	00H-7FH	0...127	00H																																								
pp=05 LFO Amplitude Depth	00H-7FH	0...127	00H																																								
Key-Based Instrument Control [GM2]	<p>F0 7F XN 0A 01 0M KK CC VV ... F7</p> <p>11110000 F0 = Exclusive status 01111111 7F = Universal Real Time 0xxxxnnn XN = When N is received N=0-F, whichever is received. X=ignored 00001010 0A = Sub-ID #1=Key-Based Instrument Control 00000001 01 = Sub-ID #2=Controller 0000mmmm 0M = MIDI Channel (00-0F) 0kkkkkkk KK = Key Number 0ccccccc CC = Controller Number 0vvvvvvv VV = Value : : 11110111 F7 = End of Exclusive</p> <p>Make sure to set both the controlled number and the value.</p> <table border="1"> <thead> <tr> <th>Control Number(CC)</th> <th>Value(VV)</th> <th>Description</th> <th>Default Value</th> </tr> </thead> <tbody> <tr> <td>CC=07H Volume</td> <td>00H-7FH</td> <td>-100...0...+100%</td> <td>40H</td> </tr> <tr> <td>CC=0AH Pan</td> <td>00H-7FH</td> <td>L63...C...R63 (absolute)</td> <td>(Preset value)</td> </tr> <tr> <td>CC=5BH Reverb Send Level</td> <td>00H-7FH</td> <td>0...Max (absolute)</td> <td>(Preset value)</td> </tr> <tr> <td>CC=5DH Chorus Send Level</td> <td>00H-7FH</td> <td>0...Max (absolute)</td> <td>(Preset value)</td> </tr> </tbody> </table>	Control Number(CC)	Value(VV)	Description	Default Value	CC=07H Volume	00H-7FH	-100...0...+100%	40H	CC=0AH Pan	00H-7FH	L63...C...R63 (absolute)	(Preset value)	CC=5BH Reverb Send Level	00H-7FH	0...Max (absolute)	(Preset value)	CC=5DH Chorus Send Level	00H-7FH	0...Max (absolute)	(Preset value)	0 (Drum Only)	X	0	X	X	X	X	X	X	0	X	0	X	X								
Control Number(CC)	Value(VV)	Description	Default Value																																								
CC=07H Volume	00H-7FH	-100...0...+100%	40H																																								
CC=0AH Pan	00H-7FH	L63...C...R63 (absolute)	(Preset value)																																								
CC=5BH Reverb Send Level	00H-7FH	0...Max (absolute)	(Preset value)																																								
CC=5DH Chorus Send Level	00H-7FH	0...Max (absolute)	(Preset value)																																								

System Exclusive Messages (Universal Non-Real Time Messages)

MIDI Event	Data Format	[MIDI]											[Song Creator]			
		Voice		MIDI Reception				MIDI Transmission					PLAY		REC	
		Regular/ Drum/ Organ Voice	Mic/Vocal Harmony	Song	Right1 Right2 Right3 Left	Keyboard	Style	Extra	Right1 Right2 Right3 Left	M.Pad	Style	Song	Upper Lower	PLAY	REW	From panel operations
GM1 System On [GM1] [GM2]	F0 7E XN 09 01 F7 11110000 F0 = Exclusive status 01111110 7E = Universal Non-Real Time 0xxxxnnn XN = When N is received N=0-F, whichever is received. X=ignored 00001001 09 = Sub-ID #1=General MIDI Message 00000001 01 = Sub-ID #2=General MIDI On 11110111 F7 = End of Exclusive	0	-											0	X	0
GM2 System On [GM2]	F0 7E XN 09 03 F7 11110000 F0 = Exclusive status 01111110 7E = Universal Non-Real Time 0xxxxnnn XN = When N is received N=0-F, whichever is received. X=ignored 00001001 09 = Sub-ID #1=General MIDI Message 00000011 03 = Sub-ID #2=General MIDI On 11110111 F7 = End of Exclusive	0	-											0	X	X
General MIDI System Off [GM1] [GM2]	F0 7E XN 09 02 F7 11110000 F0 = Exclusive status 01111110 7E = Universal Non-Real Time 0xxxxnnn XN = When N is received N=0-F, whichever is received. X=ignored 00001001 09 = Sub-ID #1=General MIDI Message 00000010 02 = Sub-ID #2=General MIDI Off 11110111 F7 = End of Exclusive	0	-											0	X	X
Scale/ Octave Tuning [GM2]	F0 7E XN 08 08 JJ GG MM SS ... F7 11110000 F0 = Exclusive status 01111110 7E = Universal Non-Real Time 0xxxxnnn XN = When N is received N=0-F, whichever is received. X=ignored 00001000 08 = Sub-ID #1=MIDI Tuning Standard 00001000 08 = Sub-ID #2=scale/octave tuning 1byte form 0jjjjjjjj JJ = Channel/option byte1 bits 0 to 1 = channel 15 to 16 bits 2 to 6 = reserved 0ggggggg GG = Channel byte2 - bits0 to 6 = channel 8 to 14 0mmmmmmmm MM = Channel byte2 - bits0 to 6 = channel 1 to 7 0sssssss SS = 12byte tuning offset of 12 semitones from C to B 00H means -64cent 40H means 0cent 7FH means +63cent : : : 11110111 F7 = End of Exclusive	0	X											0	X	X

SYSTEM EXCLUSIVE MESSAGES (2)

* Not received when Receive System Exclusive Message Parameters is set to off.
 * Not transmitted when Transmit System Exclusive Message Parameters is set to off.

System Exclusive Messages (Style)

MIDI Event	Data Format	[MIDI]												
		Voice		MIDI Reception				MIDI Transmission						
		Regular/ Drum/ Organ Voice	Mic/Vocal Harmony	Song	Right1 Right2 Right3 Left	Keyboard	Style	Extra	Right1 Right2 Right3 Left	M.Pad	Style	Song	Upper Lower	
Section Control	FO 43 7E 00 ss dd F7 11110000 F0 = Exclusive status 01000011 43 = YAMAHA ID 01111110 7E = Style 00000000 00 = 0sssssss ss = Switch No. 00H INTRO A 01H INTRO B 02H INTRO C 03H INTRO D 08H MAIN A 09H MAIN B 0AH MAIN C 0BH MAIN D 10H FILL IN AA 11H FILL IN BB 12H FILL IN CC 13H FILL IN DD 18H BREAK FILL 20H ENDING A 21H ENDING B 22H ENDING C 23H ENDING D 0ddddd dd = Switch On/Off 00H(Off) 7FH(On) 11110111 F7 = End of Exclusive	-	-			O								●
Tempo Control	FO 43 7E 01 t4 t3 t2 t1 F7 11110000 F0 = Exclusive status 01000011 43 = YAMAHA ID 01111110 7E = Style 00000001 01 = 0ttttttt t4 = tempo4 0ttttttt t3 = tempo3 0ttttttt t2 = tempo2 0ttttttt t1 = tempo1 11110111 F7 = End of Exclusive	-	-			O								●
Chord Control	FO 43 7E tt d1 d2 d3 d4 F7 Type1 (tt=02) 11110000 F0 = Exclusive status 01000011 43 = YAMAHA ID 01111110 7E = Style 00000010 02 = type 1 0ddddd d1 = chord root(cr) 0ddddd d2 = chord type(ct) 0ddddd d3 = bass note(bn) 0ddddd d4 = bass type(bt) 11110111 F7 = End of Exclusive cr : Chord Root 0fffnnnn fff: b or #, nnnn: note(root) 0000nnnn 0n bbb 0fff0000 x0 reserved 001nnnn 1n bb 0fff0001 x1 C 010nnnn 2n b 0fff0010 x2 D 001nnnn 3n natural 0fff0011 x3 E 010nnnn 4n # 0fff0100 x4 F 010nnnn 5n ## 0fff0101 x5 G 0110nnnn 6n ### 0fff0110 x6 A 0fff0111 x7 B ct : Chord Type 0 - 34,127 00000000 00 0 Maj 00010010 12 18 dim7 00000001 01 1 Maj6 00010011 13 19 7th 00000010 02 2 Maj7 00010100 14 20 7sus4 00000011 03 3 Maj7 (#11) 00010101 15 21 7b5 00000100 04 4 Maj7 (9) 00010110 16 22 7 (9) 00000101 05 5 Maj7 (9) 00010111 17 23 7 (#11) 00000110 06 6 Maj6 (9) 00011000 18 24 7 (13) 00000111 07 7 aug 00011001 19 25 7 (b9) 00001000 08 8 min 00011010 1A 26 7 (b13) 00001001 09 9 min6 00011011 1B 27 7 (#9) 00001010 0A 10 min7 00011100 1C 28 Maj7aug 00001011 0B 11 min7b5 00011101 1D 29 7aug 00001100 0C 12 min (9) 00011110 1E 30 1#8 00001101 0D 13 min7 (9) 00011111 1F 31 1#5 00001110 0E 14 min7 (11) 00100000 20 32 sus4 00001111 0F 15 minMaj7 00100001 21 33 1+2+5 00010000 10 16 minMaj7 (9) 00100010 22 34 cc 00010001 11 17 dim bn : On Bass Note Same as Chord root 127:No bass chord bt : Bass Chord Same as Chord type 127:No bass chord * Not received when Receive Chord System Exclusive Message Parameters is set to off. * Not transmitted when Transmit Chord System Exclusive Message Parameters is set to off.	-	-			O								●
	Type2 (tt=03) 11110000 F0 = Exclusive status 01000011 43 = YAMAHA ID 01111110 7E = Style 00000011 03 = type 2 0ddddd dd = note1 0ddddd dd = note2 0ddddd dd = note3 : 0ddddd dd = note10 11110111 F7 = End of Exclusive	-	-			O								X

● : Transmitted via panel operations O : Available

System Exclusive Messages (XG)

MIDI Event	Data Format	[MIDI]																
		Voice		MIDI Reception					MIDI Transmission									
		Regular/ Drum/ Organ Voice	Mic/Vocal Harmony	Song	Right1 Right2 Right3 Left	Keyboard	Style	Extra	Right1 Right2 Right3 Left	M.Pad	Style	Song	Upper Lower					
XG Parameter Changes	F0 43 1n 4C hh mm ll dd ... F7 11110000 F0 = Exclusive status 01000011 43 = YAMAHA ID 0001nnnn 1n = Device Number n=always 0(when transmit), n=0-F(when receive) 01001100 4C = Model ID 0hhhhhhh hh = Address High 0mmmmmmm mm = Address Mid 01111111 ll = Address Low 0ddddd dd = Data : : 11110111 F7 = End of Exclusive	-	-	* Refer to XG Parameter Change Table.	o							o						* Refer to XG Parameter Change Table.
XG Bulk Dump	F0 43 0n 4C aa bb hh mm ll dd ... dd cc F7 11110000 F0 = Exclusive status 01000011 43 = YAMAHA ID 0000nnnn 0n = Device Number n=always 0(when transmit), n=0-F(when receive) 01001100 4C = Model ID 0aaaaaaa aa = Byte Count MSB 0bbbbbbb bb = Byte Count LSB 0hhhhhhh hh = Address High 0mmmmmmm mm = Address Mid 01111111 ll = Address Low 0ddddd dd = Data : : 0ddddd dd = Data 0ccccc cc = Checksum 11110111 F7 = End of Exclusive	-	-	* Refer to XG Parameter Change Table.	o							o						* Refer to XG Parameter Change Table.
XG Parameter Request	F0 43 3n 4C hh mm ll F7 11110000 F0 = Exclusive status 01000011 43 = YAMAHA ID 0011nnnn 3n = Device Number n=always 0(when transmit), n=0-F(when receive) 01001100 4C = Model ID 0hhhhhhh hh = Address High 0mmmmmmm mm = Address Mid 01111111 ll = Address Low 11110111 F7 = End of Exclusive	-	-		o							o						* Refer to XG Parameter Change Table.
XG Dump Request	F0 43 2n 4C hh mm ll F7 11110000 F0 = Exclusive status 01000011 43 = YAMAHA ID 0010nnnn 2n = Device Number n=always 0(when transmit), n=0-F(when receive) 01001100 4C = Model ID 0hhhhhhh hh = Address High 0mmmmmmm mm = Address Mid 01111111 ll = Address Low 11110111 F7 = End of Exclusive	-	-		o							o						* Refer to XG Parameter Change Table.

System Exclusive Messages (Hard Disk Recorder Control)

MIDI Event	Data Format	[MIDI]																
		Voice		MIDI Reception					MIDI Transmission									
		Regular/ Drum/ Organ Voice	Mic/Vocal Harmony	Song	Right1 Right2 Right3 Left	Keyboard	Style	Extra	Right1 Right2 Right3 Left	M.Pad	Style	Song	Upper Lower					
Hard Disk Recorder Control	F0 43 73 01 50 19 00 00 dd F7 11110000 F0 = Exclusive status 01000011 43 = YAMAHA ID 01110011 73 = Tyros ID 00000001 01 = Model ID 01010000 50 = SubID 00011001 19 = SubID (Hard Disk Recorder Control) 00000000 00 = SubID 00000000 00 = SubID (Start/Stop Control) 0ddddd dd = data dd=00H:Start, 01H:Stop, 02H:Pause 11110111 F7 = End of Exclusive Controls start/stop of the audio song, but this is not synchronized with the MIDI song.	X	X		o							X	X	X	o	X		

System Exclusive Messages Special Operators (Vocal Harmony Additional Parameters)

MIDI Event	Data Format	[MIDI]											
		Voice		MIDI Reception					MIDI Transmission				
		Regular/ Drum/ Organ Voice	Mic/Vocal Harmony	Song	Right1 Right2 Right3 Left	Keyboard	Style	Extra	Right1 Right2 Right3 Left	M.Pad	Style	Song	Upper Lower
Vocal Harmony Pitch to Note ON/OFF	F0 43 73 01 11 0n 50 00 dd F7 11110000 F0 = Exclusive status 01000011 43 = YAMAHA ID 01110011 73 = Tyros ID 00000001 01 = Model ID 00010001 11 = Special Operators 0000nnnn 0n = Channel No. (Always 00) 01010000 50 = Vocal Harmony Additional Parameter Control No. 00000000 00 = Pitch to Note Parameter No. 0ddddd dd = data 00H : Off, 01H : On 11110111 F7 = End of Exclusive	X	O						O				●
Vocal Harmony Pitch to Note Part	F0 43 73 01 11 0n 50 01 dd F7 11110000 F0 = Exclusive status 01000011 43 = YAMAHA ID 01110011 73 = Tyros ID 00000001 01 = Model ID 00010001 11 = Special Operators 0000nnnn 0n = Channel No. (Always 00) 01010000 50 = Vocal Harmony Additional Parameter Control No. 00000001 01 = Pitch to Note Part Parameter No. 0ddddd dd = data 00H : Right1 01H : Right2 02H : Left 03H : (not used) 04H : Upper 11110111 F7 = End of Exclusive	X	O						O				●
Vocal Harmony Vocoder Part (Harmony Part(Pannel))	F0 43 73 01 11 0n 50 10 dd F7 11110000 F0 = Exclusive status 01000011 43 = YAMAHA ID 01110011 73 = Tyros ID 00000001 01 = Model ID 00010001 11 = Special Operators 0000nnnn 0n = Channel No. (Always 00) 01010000 50 = Vocal Harmony Additional Parameter Control No. 00010000 10 = Vocoder Part Parameter No. 0ddddd dd = data 00H : Off 01H : Upper 02H : Lower 11110111 F7 = End of Exclusive	X	O						O				●

● : Transmitted via panel operations O : Available

System Exclusive Messages (Others)

MIDI Event	Data Format	[MIDI]											
		Voice		MIDI Reception					MIDI Transmission				
		Regular/ Drum/ Organ Voice	Mic/Vocal Harmony	Song	Right1 Right2 Right3 Left	Keyboard	Style	Extra	Right1 Right2 Right3 Left	M.Pad	Style	Song	Upper Lower
Internal Clock (Clavinova compliance)	F0 43 73 01 02 F7 00000001 01 = Model ID 00000010 02 = Internal Clock Substatus	-	-						O				X
External Clock (Clavinova compliance)	F0 43 73 01 03 F7 00000001 01 = Model ID 00000011 03 = External Clock Substatus	-	-						O				X
Organ Flutes data Bulk Dump (Clavinova compliance)	F0 43 73 01 06 0B 00 00 01 06 0n [Bulk Data] sum F7 01H Model ID 06H Bulk ID 0BH Bulk No. (Organ Flutes data Bulk Dump) 00H,00H,01H,06H Data Length :16bytes 1st Channel No. 0nH 2nd Footage [1] 00 - 08H 3rd [1 1/3] 00 - 08H 4th [1 3/5] 00 - 08H 5th [2] 00 - 08H 6th [2 2/3] 00 - 08H 7th [4] 00 - 08H 8th [5 1/3] 00 - 08H 9th [8] 00 - 08H 10th [16] 00 - 08H 11th [Attack 2] 00 - 08H 12th [Attack 2 2/3] 00 - 08H 13th [Attack 4] 00 - 08H 14th Settings [Attack Length] 00 - 08H 15th [Response] 00 - 08H 16th [Attack Mode] 00 - 01H 00H: Each, 01H: First 17th [Wave Variation] 00 - 01H 00H: Sine, 01H: Vintage 18th [Volume] 01 - 09H 19th [aux] 00H 20th [aux] 00H 21th [aux] 00H 22th [aux] 00H sum Check Sum = 0-sum(BULK DATA)	O (Organ Flute)	X	O	O	X	X	O	●	X	X	O	X
MIDI Master Tuning	F0 43 1n 27 30 00 00 0n 0l cc F7 11110000 F0 = Exclusive status 01000011 43 = YAMAHA ID 0001nnnn 1n n= always 0(when transmit), n=0-F(when receive) 00100111 27 = Model ID of TG100 00110000 30 = Address High 00000000 00 = Address Mid 00000000 00 = Address Low 0000nnnn 0n = Master Tune MSB 00001111 0l = Master Tune LSB 0ccccccc cc = don't care 11110111 F7 = End of Exclusive	O	O						O				X

● : Transmitted via panel operations O : Available

Song Meta Event List

Data Format	Parameter	Description	Note
FF 05 len [Data]	Lyrics	len=Data length, [Data]=Lyrics Data	-
FF 06 len [Data]	Marker	len=Data length, [Data]=Marker	Used as a Song Position Jump Marker.
FF 51 03 t1 t2 t3	Set Tempo	t1 t2 t3 =Tempo value B7 1B 00-01 D4 C0 (Tempo 5-500)	Entered when recording.
FF 58 04 nn dd cc bb	Beat	nn=Numerator, dd=Denominator (2n) cc=MIDI clock per metronome click, bb=Number of thirty-second notes in MIDI quarter note	Entered when recording.
FF 59 02 sf mi	Key Signature	sf=-7-7 mi=0: Major key, 1: minor key	Entered from the [Score] -> SETUP display.

YAMAHA META EVENT

FF 7F 06 43 73 0A 00 07 dd	Score Start Bar	ddH: Start from this measure dd= -100-1, 1-100	Same as ScBar entered from the [SONG CREATOR] ->SYS/EX. Display
FF 7F len 43 73 0D 01 [Data]	Keyboard Voice	Voice settings for the RIGHT1-3 and LEFT	Entered to the song from the [SONG CREATOR]->CHANNEL ->SETUP display.

YAMAHA XF META EVENT

FF 7F 07 43 7B 01 cr ct bn bt	Chord Name	Refer to "Chord Control" in the MIDI Data Format (System Exclusive Messages)	Entered when recording.
FF 7F 05 43 7B 03 20 08	Phrase Mark	Used as a marker for each phrase when executing Phrase Mark repeat playback.	Used when performing the Phrase Mark repeat playback.
FF 7F 04 43 7B 04 dd	Phrase Max	Maximum Phrase Number	Used when performing the Phrase Mark repeat playback.
FF 7F 05 43 7B 0C rr ll	Guide Track Flag	Sets the TRACK1 and TRACK2 parameters on the [FUNCTION]-> [SONG SETTING] display. rr = RIGHT CH (0: OFF, 1-16CH) ll = LEFT CH (0: OFF, 1-16CH)	Entered when recording.
FF 7F len 43 7B 21 00 pp [Data]	Lyrics Bitmap	Specifies the background picture of the Lyrics display. pp=Display type (0: Center, 1: Tile) [Data]=File Path	Entered to the song from the [SONG CREATOR]->CHANNEL ->SETUP display.

Song System Exclusive Message List

Data Format	Parameter	Description	Note
-------------	-----------	-------------	------

Guide

F0 43 73 01 1F 00 cc dd F7	Guide Mode	ccH = Part Select No 00H (RIGHT CH=ON, LEFT CH=ON) 01H (RIGHT CH=OFF, LEFT CH=ON) 02H (RIGHT CH=ON, LEFT CH=OFF) 03H (RIGHT CH=OFF, LEFT CH=OFF) ddH = Mode 00H=Guide OFF 01H=Follow Lights 02H=Any Key 03H=Karao-Key 04H=Vocal CueTIME	Entered to the song from the [SONG CREATOR]->CHANNEL->SETUP display.
----------------------------	------------	---	--

Score

F0 43 73 01 50 12 00 00 dd F7	Left Part indication On/Off	00H: OFF, 7FH:ON	Entered to the song from the [SONG CREATOR]->CHANNEL->SETUP display.
F0 43 73 01 50 12 00 01 dd F7	Right Part indication On/Off	00H: OFF, 7FH:ON	
F0 43 73 01 50 12 00 02 dd F7	Lyrics indication On/Off	00H: OFF, 7FH:ON	
F0 43 73 01 50 12 00 03 dd F7	Chord indication On/Off	00H: OFF, 7FH:ON	
F0 43 73 01 50 12 00 04 dd F7	N.Name indication On/Off	00H: OFF, 7FH:ON	
F0 43 73 01 50 12 00 05 dd F7	Size designation	00H:SMALL, 01H:MIDDLE, 02H:LARGE, 03H:X-LARGE	
F0 43 73 01 50 12 00 06 dd F7	Left Ch	00H-0FH=CH, 7EH=OFF, 7FH=AUTO	
F0 43 73 01 50 12 00 07 dd F7	Right Ch	00H-0FH=CH, 7EH=OFF, 7FH=AUTO	
F0 43 73 01 50 12 00 08 dd F7	Quantize triplet On/Off	00H: Triplet OFF, 7FH: Triplet ON	
F0 43 73 01 50 12 00 09 dd F7	Quantize	00H: quarter, 01H: eighth, 02H: sixteenth, 03H: thirty-second	
F0 43 73 01 50 12 00 0A dd F7	NoteName	00H:ABC, 01H:FixedDo, 02H:MovableDo	
F0 43 73 01 50 12 00 0B dd F7	Color Note	00H:OFF, 7FH:ON	

Style

F0 43 73 01 51 00 00 03 10 00 dd F7	STYLE SPLIT POINT	dd=STYLE SPLIT POINT (Note Number)	Entered to the song from the [SONG CREATOR]->CHANNEL->SETUP display.
F0 43 73 01 51 05 00 03 04 00 00 dd dd F7	Style No.	dd dd = Style No.	Entered when recording.
F0 43 7E 00 ss dd F7	Section Control	Refer to the MIDI Data Format.	Entered when recording.

Hard Disk Recorder

F0 43 73 01 50 19 00 00 dd F7	Hard Disk Recorder Control	Controls start/pause/stop of the audio song, but this is not synchronized with the MIDI song. 00H:Start, 01H:Stop,02H:Pause	Edited from the [SONG CREATOR]->SYS->EX display.
-------------------------------	----------------------------	--	--

DIGITAL WORKSTATION

TYROS

PARTS LIST

■ CONTENTS

OVERALL ASSEMBLY	2
UPPER CASE UNIT	4
LOWER CASE UNIT	7
LCD UNIT	10
KEYBOARD ASSEMBLY	12
WHEEL ASSEMBLY	14
ELECTRICAL PARTS	15-54

Notes : DESTINATION ABBREVIATIONS

A : Australian model	M : South African model
B : British model	O : Chinese model
C : Canadian model	Q : South-east Asia model
D : German model	T : Taiwan model
E : European model	U : U.S.A. model
F : French model	V : General export model (110V)
H : North European model	W : General export model (220V)
I : Indonesian model	N,X: General export model
J : Japanese model	Y : Export model
K : Korean model	

■ WARNING

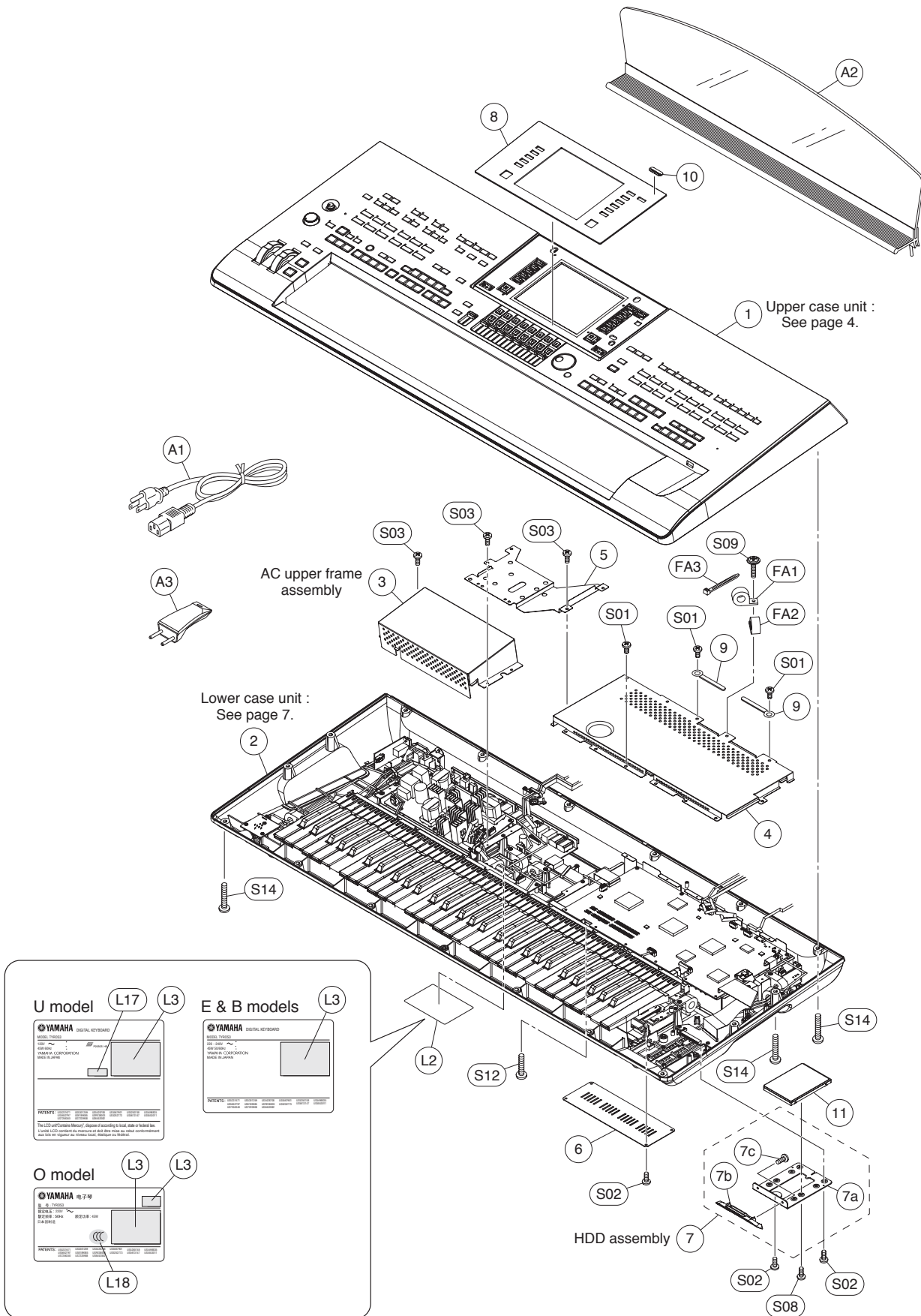
Components having special characteristics are marked  and must be replaced with parts having specification equal to those originally installed.

- The numbers “QTY” show quantities for each unit.
- The parts with “-” in “PART NO.” are not available as spare parts.
- This mark “}” in the REMARKS column means these parts are interchangeable.
- The second letter of the shaded (■) part number is O, not zero.
- The second letter of the shaded (■) part number is I, not one.

※※※※※ Parts marked with “※1” are applicable to products with serial number up to B00 01470, E00 02830, U00 01285 and ET00 01125. ※※※※※

※※※※※ Parts marked with “※2” are applicable to products with serial number from B00 01471, E00 02831, U00 01286 and ET00 01126. ※※※※※

OVERALL ASSEMBLY

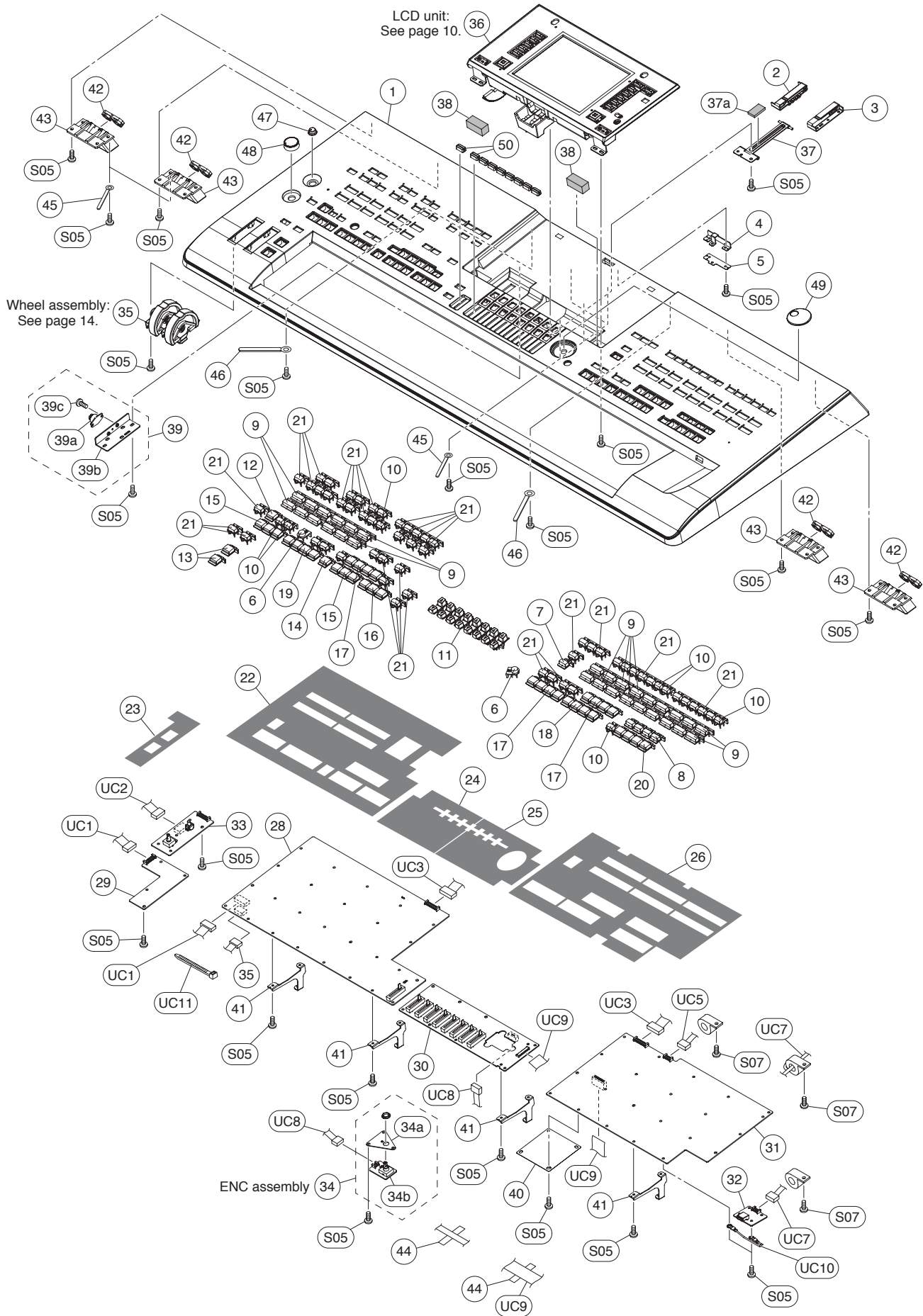


REF NO.	PART NO.	DESCRIPTION		部 品 名	REMARKS	QTY	RANK
		OVERALL ASSEMBLY		総 組 立	Tyros3		
1	--	OVERALL ASSEMBLY		総 組 立	(WN43920)		
2	--	UPPER CASE UNIT		上 ケ ー ス ユ ニ ッ ト	(WN11920)		
3	--	LOWER CASE UNIT		下 ケ ー ス ユ ニ ッ ト	(WN10380)		
4	--	AC UPPER FRAME ASSEMBLY		電 源 上 フ レ ー ム A s s ' y	(WF32810)		
5	--	DM COVER		D M カ バ ー	(WN42610)		
6	WN440000	ACDM EARTH ANGLE		A C D M ア ー ス 金 具	(WN43990)		
7	--	DIMM COVER		D I M M カ バ ー			
7a	WN218200	HDD ASSEMBLY		H D D _ A s s ' y	(WN33210)		
7b	WN218200	HDD BRACKET		H D D ブ ラ ケ ッ ト			
7c	WN332300	HDD FRONT COVER		H D D フ ロ ン ト カ バ ー			
8	WE774301	BIND HEAD TAPPING SCREW-B	3.0X8 MFZN2W3	B タ イ ト + B I N D		2	
9	WN517800	LCD COVER		L C D カ バ ー			
10	CB81751R	WIRE CLIP	S-14B-E,S-14	束 線 止 め		2	03
11	--	LCD LABEL		L C D ラ ベ ル	(V218020)		
12	WP376100	HARD DISK DRIVE UNIT	2.5 inch 80GB	ハ ー ド デ ィ ス ク			
S01	--	WIRING ASSEMBLY	FA	F A 束 線 構 成	(WN15380)		
S02	WE774000	BIND HEAD SCREW	3.0X6 MFZN2W3	小 ネ ジ + B I N D		11	
S03	WE983600	BIND HEAD SCREW	3.0X8 MFZN2B3	小 ネ ジ + B I N D		7	
S08	WE774301	BIND HEAD TAPPING SCREW-B	3.0X8 MFZN2W3	B タ イ ト + B I N D		6	
S09	VG048000	BIND HEAD SCREW	3.0X4 MFNI33	+ バ イ ン ド 小 ネ ジ		4	01
S12	WP817100	PW HEAD MACHINE SCREW	3.0 X 12 MFZN2W3	小 ネ ジ + P W H		1	
S14	WE96650R	BIND HEAD SCREW	4.0X10 MFZN2W3	小 ネ ジ + B I N D		4	01
	WF15410R	BIND HEAD TAPPING SCREW-B	4.0X16 MFZN2W3	B タ イ ト + B I N D		25	01
FA1	--	WIRING ASSEMBLY	FA	F A 束 線 構 成	(WN15380)		
FA1	V312290R	DATA LINE FILTER	K1 NFT-13BK2	デ ー タ ラ イ ン フ ィ ル タ			06
FA2	VD94780R	DATA LINE FILTER	ESD-R-25D-B	デ ー タ ラ イ ン フ ィ ル タ			05
FA2	V312290R	DATA LINE FILTER	K1 NFT-13BK2	デ ー タ ラ イ ン フ ィ ル タ			06
FA2	VD94780R	DATA LINE FILTER	ESD-R-25D-B	デ ー タ ラ イ ン フ ィ ル タ			05
FA3	CB06925R	BINDING TIE	BK-1 (10pcs/pack)	イ ン シ ュ ロ ッ ク タ イ			01
FA3	VV55840R	CORD BINDER	AZ-100	結 束 バ ン ド			01
A1	--	ACCESSORIES		付 属 品			
A1	V6190600	AC CORD	CSA UC-972-N01	電 源 コ ー ド C S A	U		
A1	V619070R	AC CORD	VDE EC-857-N01	電 源 コ ー ド V D E	E		08
A1	WE66730R	AC CORD	BS	電 源 コ ー ド	B		09
A2	WC901301	POWER SUPPLY CORD	CHN 3P 2.5m	電 源 コ ー ド セ ッ ト	O		
A3	WB530800	MUSIC REST		譜 面 板 (箱 入 り)			15
A4	WF18010R	SCORE STAND ASSEMBLY		ス タ ン ド 袋 入 り		2	
L2	X9878B00	CD-ROM		光 デ ィ ス ク			
L2	--	NAME PLATE	U	銘 板	U		(WQ31400)
L2	--	NAME PLATE	E	銘 板	E,B		(WQ31410)
L2	--	NAME PLATE	CHN	銘 板	O		(WQ31420)
L3	--	LABEL		商 品 ラ ベ ル			(WC19230)
L17	VA039300	LABEL	DE-TOKO-DO	ラ ベ ル	U		03
L18	--	LABEL	CCC AV	ラ ベ ル	O		(WA65000)

*: New Parts

RANK: Japan only

UPPER CASE UNIT



REF NO.	PART NO.	DESCRIPTION		部 品 名	REMARKS	QTY	RANK
* 1	WN097500	UPPER CASE UNIT		上 ケース ユニッ ト	Tyros3		
2	V913660R	UPPER CASE UNIT		上 ケース ユニッ ト	(WN11920)		02
3	V913670R	UPPER CASE		上 ケース 印 刷 品			02
		STAY GUIDE MOLDING L	LEFT	ス テイ ガイ ド 成 形 品 L			
		STAY GUIDE MOLDING R	RIGHT	ス テイ ガイ ド 成 形 品 R			
4	--	LCD LOCK PLATE		L C D ロ ッ ク プ レ ー ト	(WF30630)		
5	--	LOCK PLATE COVER		ロ ッ ク プ レ ー ト 蓋	(WF30640)		
* 6	WP216000	PANEL BUTTON	x1	パ ネ ル ボ タ ン 塗 装 品	TAP TEMPO,ENTER	2	
* 7	WN134400	BUTTON ASSEMBLY	x1	ボ タ ン A s s ' y	MUSIC FINDER		
* 8	WN134700	BUTTON ASSEMBLY	x4	ボ タ ン A s s ' y	PART SELECT		
* 9	WP216100	PANEL BUTTON	3x2	パ ネ ル ボ タ ン 塗 装 品	STYLE([POP&ROCK],..., [FILE ACCESS]),VOICE ([PIANO],...[USER DRIVE])	5	
* 10	WP216200	PANEL BUTTON	x1	パ ネ ル ボ タ ン 塗 装 品	STYLE CONTROL([OTS LINK], [AUTO FILL IN]),SONG[LOOP], HARD DISK RECORDER ([SELECT],[SETTING]), VOICE EFFECT[VARIATION], PART ON/OFF[LEFT HOLD]	7	
* 11	WP216300	PANEL BUTTON	x16	パ ネ ル ボ タ ン 塗 装 品	[1]-[8](up/down)		
* 12	WN135500	BUTTON ASSEMBLY	x1	ボ タ ン A s s ' y	STYLE CONTROL [ACMP]	2	
* 13	WN297700	BUTTON ASSEMBLY	x1	ボ タ ン A s s ' y	ART.1,ART.2		
* 14	WN135900	BUTTON ASSEMBLY	x1	ボ タ ン A s s ' y	STYLE CONTROL [BREAK]		
* 15	WN136000	BUTTON ASSEMBLY	x3	ボ タ ン A s s ' y	ENDING/rit. ([I]-[III]) INTRO ([I]-[III])	2	
* 16	WN136100	BUTTON ASSEMBLY	X3	ボ タ ン A s s ' y	STYLE CONTROL([SYNC STOP], [SYNC START],[START/STOP])		
* 17	WN136200	BUTTON ASSEMBLY	x4	ボ タ ン A s s ' y	MULTI PAD CONTROL[1]-[4], ONE TOUCH SETTING[1]-[4], REGISTRATION MEMORY[1]-[4]	3	
* 18	WN136300	BUTTON ASSEMBLY	x4	ボ タ ン A s s ' y	REGISTRATION MEMORY[5]-[8]		
* 19	WN136400	BUTTON ASSEMBLY	x4	ボ タ ン A s s ' y	MAIN VARIATION ([A],[B], [C],[D])		
* 20	WN136500	BUTTON ASSEMBLY	x4	ボ タ ン A s s ' y	AART ON/OFF ([LEFT], [RIGHT1]-[RIGHT3])		
* 21	WP216400	PANEL BUTTON	x1,x2,x3,x5,x6	パ ネ ル ボ タ ン 塗 装 品	DEMO,FADE IN/OUT,UPPER OCTAVE -/+ ,MIC ([VH TYPE SELECT],...[TALK]),SONG ([I],...[SCORE]),TRANSPOSE [-]/[+],MIXING CONSOLE, TEMPO [-]/[+],MULTI PAD CONTROL([SELECT],[STOP]), CHANNEL ON/OFF,BALANCE, MENU([FUNCTION],... [DIGITAL RECORDING]), HARDDISK RECORDER([REC], ...[NEXT]),VOICE EFFECT ([HARMONY/ECHO],...[DSP]), INTERNET,REGISTRATION MEMORY(REGISTBANK [-]/[+], [FREEZE],[MEMORY])	9	
22	--	NONWOVEN FABLIC CLOTH	L	不 織 布	(WN11930)		
23	--	NONWOVEN FABLIC CLOTH	LL	不 織 布	(WN11940)		
24	--	NONWOVEN FABLIC CLOTH	CL	不 織 布	(WN11950)		
25	--	NONWOVEN FABLIC CLOTH	CR	不 織 布	(WN11960)		
26	--	NONWOVEN FABLIC CLOTH	R	不 織 布	(WN11970)		
27	--	WIRING ASSEMBLY	UC	U C 束 線 構 成	(WN15390)		
* 28	WK611300	CIRCUIT BOARD	PNL	P N L シ ー ト			
* 29	WK611900	CIRCUIT BOARD	PNLS	P N L S シ ー ト			
* 30	WK611400	CIRCUIT BOARD	PNC	P N C シ ー ト			
* 31	WK599200	CIRCUIT BOARD	PNR	P N R シ ー ト			
* 32	WK611700	CIRCUIT BOARD	USB	U S B シ ー ト			
* 33	WM239800	CIRCUIT BOARD	MICVR	M I C V R シ ー ト			
34	--	ENC ASSEMBLY		E N C _ A s s ' y	(WN13660)		
34a	--	ENC STAY	1.0 PLATE	E N C 固 定 金 具	(WH43150)		
* 34b	WK611800	CIRCUIT BOARD	EN	E N シ ー ト			
35	--	WHEEL ASSEMBLY		ホ イ ー ル A s s ' y	(WN84220)		
* 36	WN136900	LCD UNIT		L C D ユ ニ ッ ト			
37	--	STAY HINGE ASSEMBLY		ス テ イ 金 具 A s s ' y	(WN59290)		
37a	--	ANTIVIBRATION FOAM	25X15	防 振 フ ォ ー ム	(WA52230)		

*: New Parts

RANK: Japan only

REF NO.	PART NO.	DESCRIPTION		部 品 名	REMARKS	QTY	RANK
38	--	DUST PROOF SPONGE	CALMFLEX F-2	防 塵 フ ォ ー ム	(V929030)	2	
39	--	DUMPER ASSEMBLY		ダ ン パ ー A s s ' y	(WN75330)		
39a	V928760R	ROTARY DAMPER	PT	ロ ー タ リ ー ダ ン パ ー			06
39b	--	DUMPER STAY		ダ ン パ ー 取 付 け 金 具	(WN64950)		
39c	WE774000	BIND HEAD SCREW	3.0X6 MFZN2W3	小 ネ ジ + B I N D		2	
40	--	PROTECT SHEET		保 護 シ ー ト	(WN11980)		
41	--	PANEL STAY		パ ネ ル ス テ イ	(WN11910)	4	
42	WF11020R	STABILIZER		ス タ ビ ラ イ ザ ー		4	02
43	WN142900	ROD HOLDER		ロ ッ ド ホ ル ダ ー		4	
44	22764900	ADHESIVE TAPE	12X50m	粘 着 テ ー プ		2	
44	VP83460R	FILAMENT TAPE	12X50m	粘 着 テ ー プ		2	
45	CB829850	CORD HOLDER	S-34B-E	束 線 止 め		6	03
46	CB81751R	WIRE CLIP	S-14B-E,S-14	束 線 止 め		3	03
47	V2300100	KNOB VR		V R ノ ブ	INPUT VOLUME		04
48	VQ218900	KNOB MASTER VOLUME		V ー ツ マ ミ	MASTER VOLUME		03
49	VQ664100	ENCODER KNOB		エ ン コ ー ダ ツ マ ミ	DATA ENTRY		02
50	WN163600	SLIDER KNOB		ス ラ イ ダ ー ノ ブ	ASSIGN,[1]-[8] sliders	9	
S05	WE774200	BIND HEAD TAPPING SCREW-B	3.0X10 MFZN2W3	B タ イ ト + B I N D		110	
S07	WF00210R	PW HEAD TAPPING SCREW-B	3.0X12 MFZN2W3	B タ イ ト + P W H		3	01
UC1	--	WIRING ASSEMBLY	UC	U C 束 線 構 成	(WN15390)		
UC2	--	WIRING ASSEMBLY	PNLS PH-PH 10P-120	P N L S 束 線	(WN54580)		
UC3	--	WIRING ASSEMBLY	VOL PH-PH 11P-720	V O L 束 線	(WQ38330)		
UC5	WM858800	WIRING ASSEMBLY	PNLR PH-PH 13P-550	P N L R 束 線	(WN54570)		
UC7	--	USB CABLE	6P-700L	E B U S P ー L F 束 線			
UC8	VK097400	USB CABLE	6P-700L	U S B ケ ー ブ ル	(WM51940)		
UC9	WN834100	WIRING ASSEMBLY	KRD-KRD 4P-100	K R D ー K R D 束 線			02
UC10	--	WIRING ASSEMBLY	22P-100L	F F C ケ ー ブ ル			
UC11	CB06925R	BINDING TIE	GND1 LUG-LUG L=70	G N D 1 束 線	(WN74950)		
UC11	VV55840R	CORD BINDER	BK-1 (10pcs/pack)	イ ン シ ュ ロ ッ ク タ イ			01
UC11	VV55840R	CORD BINDER	AZ-100	結 束 バ ン ド			01

*: New Parts

RANK: Japan only

REF NO.	PART NO.	DESCRIPTION	部 品 名	REMARKS	QTY	RANK
	--	LOWER CASE UNIT		Tyros3		
*	1	LOWER CASE UNIT		(WN10380)		
	1a	LOWER CASE ASSEMBLY				
	1b	FOOT	T1.6	下 ケース ユニッ ト 下 ケース ユニッ ト 下 ケース A s s ' y ゴ ム 脚	4	01
	1c	RUBBER INSULATOR	T1.6	ゴ ム 脚		
	1d	CUSHION		ク ッ シ ョ ン		
*	2	CUSHION		ク ッ シ ョ ン		
*	2	CIRCUIT BOARD	HP	H P シ ー ト		
*	3	CIRCUIT BOARD	AJK	A J K シ ー ト		
*	4	KNOB VR		V R ノ ブ	LINE IN/MIC [TRIM]	04
	5	POWER SWITCH ANGLE		P S W ア ン グ ル	(WE13590)	
	6	PUSH BUTTON		プ ッ シ ュ ボ タ ン	POWER ON/OFF	03
	7	WIRING ASSEMBLY	LC	L C 束 線 構 成	(WN15410)	
*	8	CIRCUIT BOARD	CK	C K シ ー ト		
	9	AC LOWER FRAME ASSEMBLY		電 源 下 フ レ ー ム A s s ' y	(WN55820)	
*	10	POWER SUPPLY UNIT	CE,U,CS	電 源 ユ ニ ッ ト		
*	11	CIRCUIT BOARD	SPOL	S P O L シ ー ト		
*	12	CIRCUIT BOARD	SPOR	S P O R シ ー ト		
*	13	CIRCUIT BOARD	HDSB	H D S B シ ー ト		
	14	DM ANGLE ASSEMBLY		D M ア ン グ ル A s s ' y	(WQ43100)	
	14a	ADHESIVE TAPE	ECT W=15mm	綿 粘 着 テ ー プ	(ZL35000)	
	14a	ADHESIVE CLOTH-TAPE	15mmX30m	ア セ テ ー ト ク ロ ス 粘 着	(WG52680)	
*	15	CIRCUIT BOARD	DJK	D J K シ ー ト		
*	16	CIRCUIT BOARD	DM	D M シ ー ト		
	17	KEYBOARD ASSEMBLY		M K ユ ニ ッ ト	(WN50810)	
	18	CORD HOLDER	S-34B-E	束 線 止 め		11 03
	19	WIRE CLIP	S-14B-E,S-14	束 線 止 め		5 03
*	20	SHIELD SHEET MK		シ ー ル ド シ ー ト M K		
	S01	BIND HEAD SCREW	3.0X6 MFZN2W3	小 ネ ジ + B I N D		2
	S02	BIND HEAD SCREW	3.0X8 MFZN2B3	小 ネ ジ + B I N D		
	S03	BIND HEAD TAPPING SCREW-B	3.0X8 MFZN2W3	B タ イ ト + B I N D		45
	S04	BIND HEAD TAPPING SCREW-B	3.0X10 MFZN2B3	B タ イ ト + B I N D		22 01
	S05	BIND HEAD TAPPING SCREW-B	3.0X10 MFZN2W3	B タ イ ト + B I N D		5
	S07	PW HEAD TAPPING SCREW-B	3.0X12 MFZN2W3	B タ イ ト + P W H		8 01
	S11	BIND HEAD SCREW	4.0X8 MFZN2W3	小 ネ ジ + B I N D		01
	S21	HEXAGONAL LOCK SCREW	HFS-4S-B1WM	6 角 ロ ッ ク ネ ジ		2
	M1	KEYBOARD ASSEMBLY		M K ユ ニ ッ ト	(WN50810)	
	M2	KEYBOARD ASSEMBLY	FSX D C61 K6	F S X 鍵 盤 D		
	M2	CORD HOLDER	S-34B-E	束 線 止 め		2 03
	M3	WIRING ASSEMBLY	MK EBUSK-LF KRD-KRD 7P	M K 束 線 構 成	L=500 (WN71300)	
	M3a	DATA LINE FILTER	K1 NFT-13BK2	デ ー タ ラ イ ン フ ィ ル タ		06
	M3a	DATA LINE FILTER	ESD-R-25D-B	デ ー タ ラ イ ン フ ィ ル タ		05
	MS03	BIND HEAD TAPPING SCREW-B	3.0X8 MFZN2W3	B タ イ ト + B I N D		2
	MS13	BIND HEAD TAPPING SCREW-B	4.0X12 MFZN2W3	B タ イ ト + B I N D		01
*	LC1	WIRING ASSEMBLY	LC	L C 束 線 構 成	(WN15410)	
	LC1a	WIRING ASSEMBLY	HP-LF 6P-600	H P - L F 束 線		
	LC1a	DATA LINE FILTER	K1 NFT-13BK2	デ ー タ ラ イ ン フ ィ ル タ		06
	LC1a	DATA LINE FILTER	ESD-R-25D-B	デ ー タ ラ イ ン フ ィ ル タ		05
	LC2	WIRING ASSEMBLY	ACIN VH 3P	A C I N 束 線	(WM51340)	
	LC2a	AC-IN CONNECTOR ACINLET	R-301(B18)	A C イ ン レ ッ ト	AC IN	02
	LC2b	PUSH SWITCH	SDDL13600	プ ッ シ ュ S W	POWER ON/OFF	03
	LC2c	PLUG COVER	TRANSPARENCE	プ ラ グ カ バ ー		04
	LC2d	POWER SWITCH COVER	IVORY/BLACK	パ ワ ー ス イ ッ チ カ バ ー		01
	LC3	WIRING ASSEMBLY	SW-PNL 5P/2P-500	S W - P N L 束 線	(WN54830)	
	LC4	WIRING ASSEMBLY	SPR VH-VH 3P-1500	S P R 束 線	(WN75410)	
	LC4a	DATA LINE FILTER	K1 NFT-13BK2	デ ー タ ラ イ ン フ ィ ル タ		06
	LC4a	DATA LINE FILTER	ESD-R-25D-B	デ ー タ ラ イ ン フ ィ ル タ		05
	LC5	WIRING ASSEMBLY	DM-PWR 7P/6P-850	D M - P W R 束 線	(WM69050)	
	LC5a	DATA LINE FILTER	K1 NFT-13BK2	デ ー タ ラ イ ン フ ィ ル タ		06
	LC5a	DATA LINE FILTER	ESD-R-25D-B	デ ー タ ラ イ ン フ ィ ル タ		05
	LC6	WIRING ASSEMBLY	AJK-PWR 3P-170	A J K - P W R 束 線	(WN78550)	
	LC7	WIRING ASSEMBLY	SW-CK-HD 6P-2P/2P-900	S W - C K - H D 束 線	(WN54840)	
	LC7a	DATA LINE FILTER	K1 NFT-13BK2	デ ー タ ラ イ ン フ ィ ル タ		06
	LC7a	DATA LINE FILTER	ESD-R-25D-B	デ ー タ ラ イ ン フ ィ ル タ		05
*	LC8	WIRING ASSEMBLY	FFC2 24P-200L	F F C 2 束 線		
*	LC8a	FERRITE CORE	FSRC310120RN00T	フ ェ ラ イ ト コ ア		
	LC9	WIRING ASSEMBLY	JKDET-LF KRD-KRD 6P	J K D E T - L F 束 線	(WM85670)	
	LC9a	DATA LINE FILTER	K1 NFT-13BK2	デ ー タ ラ イ ン フ ィ ル タ		06

*: New Parts

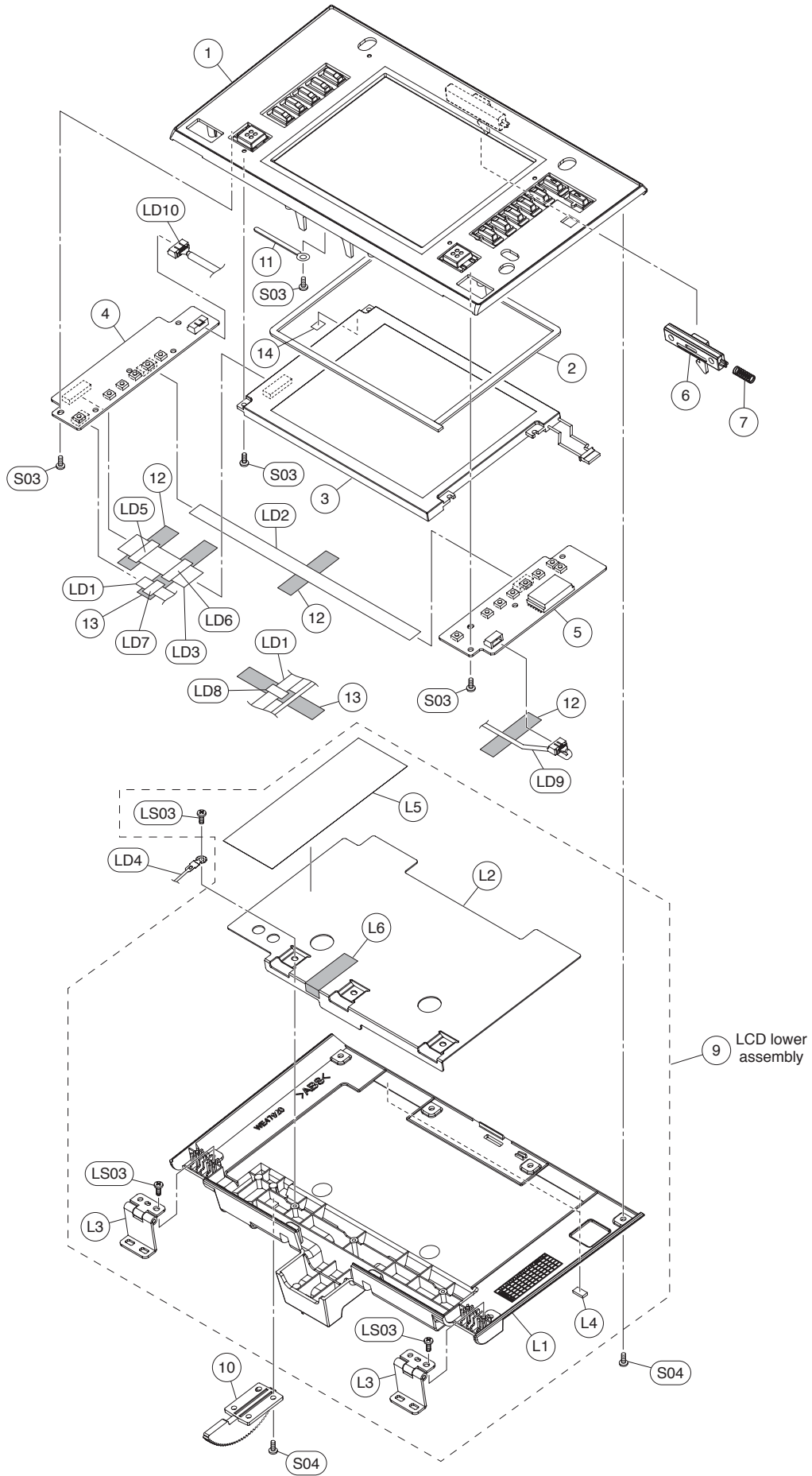
RANK: Japan only

REF NO.	PART NO.	DESCRIPTION		部 品 名	REMARKS	QTY	RANK
LC10	--	WIRING ASSEMBLY	VIDEO PH-PH 12P-300	V I D E O 束 線	(WE84670)		
LC11	WN833700	FFC CABLE	17P-250L	F F C ケ ー ブ ル			
LC12	--	WIRING ASSEMBLY	USB-PWR PH-PH 4P-210	U S B - P W R 束 線	(WN73550)		
LC13	WF76120R	WIRING ASSEMBLY	FFC1 40P-180 (HDD)	F F C 1 束 線			08
LC13a	--	FERRITE CORE	BP53RD080510120M	フ ェ ラ イ ト コ ア	(VP73330)	2	
LC14	--	WIRING ASSEMBLY	EPPH1 PHR-3 3P	ア ー ス 線 E P P H 1	(WG26500)		
LC14a	V312290R	DATA LINE FILTER	K1 NFT-13BK2	デ ー タ ラ イ ン フ ィ ル タ	}		06
LC14a	VD94780R	DATA LINE FILTER	ESD-R-25D-B	デ ー タ ラ イ ン フ ィ ル タ			05
LC15	--	WIRING ASSEMBLY	EPPH1 PHR-3 3P	ア ー ス 線 E P P H 1	(WG26500)		
LC15a	V312290R	DATA LINE FILTER	K1 NFT-13BK2	デ ー タ ラ イ ン フ ィ ル タ	}		06
LC15a	VD94780R	DATA LINE FILTER	ESD-R-25D-B	デ ー タ ラ イ ン フ ィ ル タ			05
LC16	V312290R	DATA LINE FILTER	K1 NFT-13BK2	デ ー タ ラ イ ン フ ィ ル タ	}		06
LC16	VD94780R	DATA LINE FILTER	ESD-R-25D-B	デ ー タ ラ イ ン フ ィ ル タ			05

*: New Parts

RANK: Japan only

LCD UNIT

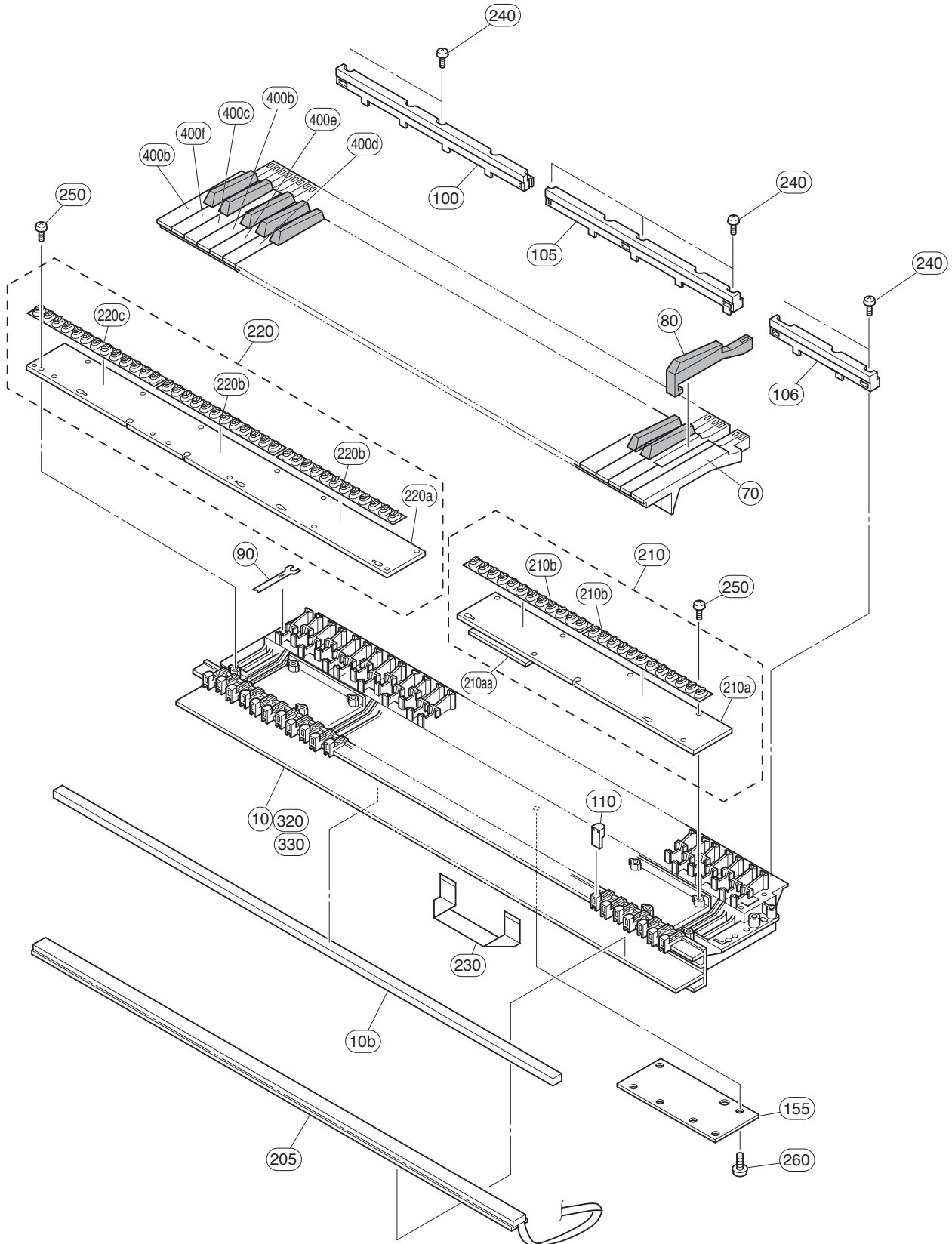


REF NO.	PART NO.	DESCRIPTION		部 品 名	REMARKS	QTY	RANK
		LCD UNIT		L C D ユ ニ ッ ト	Tyros3		
*	WN136900	LCD UNIT		L C D ユ ニ ッ ト			
* 1	WN137000	LCD UPPER CASE		L C D 上 ケース 塗 装 品			
2	--	DUST PROOF FOAM		防 塵 フ ォ ー ム	(WN21370)		
* 3	WN675600	CRYSTAL DISPLAY	LTA075A363F	液 晶 デ ィ ス プ レ イ			
* 4	WK611500	CIRCUIT BOARD	LCL	L C L シ ー ト			
* 5	WK611600	CIRCUIT BOARD	LCR	L C R シ ー ト			
6	--	LCD HOOK HOLDER		L C D フ ッ ク ホ ル ダ ー	(WF25560)		
7	V928820R	RETURN SPRING		リ タ ー ン ス プ リ ン グ			
8	--	WIRING ASSEMBLY	LD	L D 束 線 構 成	(WN15400)		
9	--	LCD LOWER CASE ASSEMBLY		L C D 下 ケース A s s ' y	(WN13740)		
10	V913540R	GEAR		ギ ャ ー 成 形 品			01
11	CB829850	CORD HOLDER	S-34B-E	束 線 止 め			03
12	22764900	ADHESIVE TAPE	12X50m	粘 着 テ ー プ	}	3	
12	VP83460R	FILAMENT TAPE	12X50m	粘 着 テ ー プ		3	
13	22764900	ADHESIVE TAPE	12X50m	粘 着 テ ー プ	}	2	
13	VN195401	ADHESIVE TAPE	12X70m	粘 着 テ ー プ		2	03
* 14	WQ837500	CUSHION		ク ッ シ ョ ン			
S03	WE774301	BIND HEAD TAPPING SCREW-B	3.0X8 MFZN2W3	B タ イ ト + B I N D		14	
S04	WE972200	BIND HEAD TAPPING SCREW-B	3.0X10 MFZN2B3	B タ イ ト + B I N D		12	01
	--	LCD LOWER CASE ASSEMBLY		L C D 下 ケース A s s ' y	(WN13740)		
* L1	WN137300	LCD L CASE	LOWER	L C D 下 ケース 成 形 品	(WF30650)		
L2	--	LCD SUPPORT STAY		L C D 補 強 金 具	(WF30620)	2	
L3	--	HINGE		蝶 番 金 具			
L4	V934810R	FOOT	T2.0	ゴ ム 脚		2	01
L5	--	INSULATION FILM L	RUMIRA-S10	絶 縁 フ ィ ル ム L	(V942440)		
L6	22764900	ADHESIVE TAPE	12X50m	粘 着 テ ー プ	}		
L6	VA126101	FILAMENT TAPE	12X50m	粘 着 テ ー プ			01
LS03	WE774301	BIND HEAD TAPPING SCREW-B	3.0X8 MFZN2W3	B タ イ ト + B I N D		7	
	--	WIRING ASSEMBLY	LD	L D 束 線 構 成	(WN15400)		
* LD1	WN833900	FFC CABLE	8P-330L	F F C ケ ー ブ ル			
* LD2	WN834000	FFC CABLE	9P-220L	F F C ケ ー ブ ル			
* LD3	WN834200	FFC CABLE	32P-50L	F F C ケ ー ブ ル			
LD4	--	WIRING ASSEMBLY	GND2 LUG-LUG L=240	G N D 2 束 線	(WN74960)		
* LD5	WH416800	FERRITE CORE	FSRC222120RX000T	デ ー タ ラ イ ン フ ィ ル タ			
* -8	WH416800	FERRITE CORE	FSRC222120RX000T	デ ー タ ラ イ ン フ ィ ル タ			
LD9	--	WIRING ASSEMBLY	CK-LC-DM PH5P/4P/2P	C K - L C - D M 束 線	L=1000 (WN54850)		
* LD10	WM519500	LVDS CABLE	5P-1250L	L V D S ケ ー ブ ル			

*: New Parts

RANK: Japan only

KEYBOARD ASSEMBLY

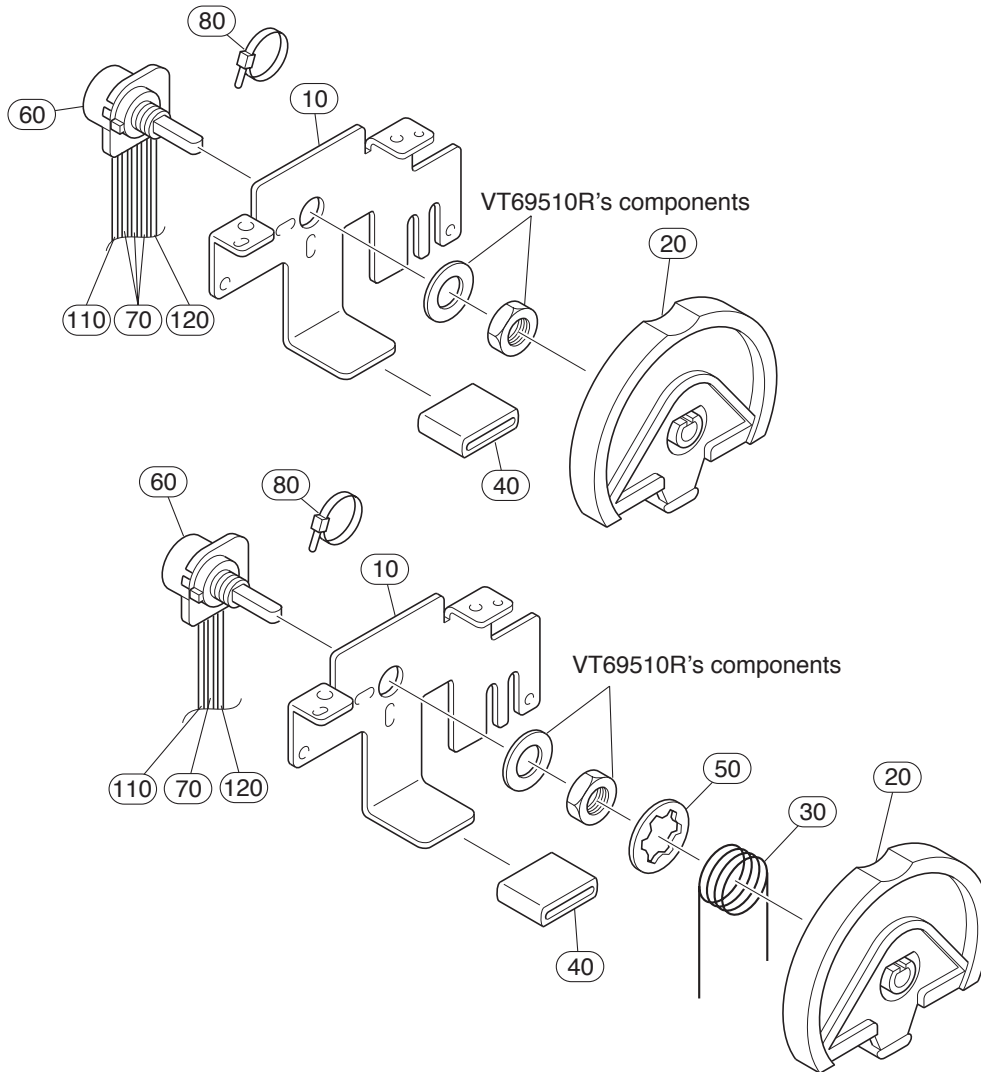


REF NO.	PART NO.	DESCRIPTION	部 品 名	REMARKS	QTY	RANK
		KEYBOARD ASSEMBLY	F S X 鍵 盤 D	Tyros3		
	WD53490R	KEYBOARD ASSEMBLY	F S X 鍵 盤 D			
10	--	KEYBOARD FRAME	M K フ レ ー ム	(WD5349A)		
10a	--	KEYBOARD FRAME	M K フ レ ー ム	(WD80950)		
10b	WD80450R	STOPPER U	ス ト ッ パ ー U			04
70	WB16730R	WHITE KEY ASSEMBLY C'	白 鍵 A s s ' y C'	C6		03
80	WB16740R	BLACK KEY ASSEMBLY	黒 鍵 A s s ' y		25	03
90	WB16760R	KEY SPRING	鍵 バ ネ		61	
100	WC436600	KEY STOPPER L	キ ー ス ト ッ パ ー L			03
105	WC436700	KEY STOPPER H	キ ー ス ト ッ パ ー H			03
106	WD80420R	KEY STOPPER	キ ー ス ト ッ パ ー 6 1			02
110	WB17110R	KEY GUIDE CAP	キ ー ガ イ ド キ ャ ッ プ		61	01
155	--	FRAME FITTING ANGLE	フ レ ー ム 固 定 金 具	(WB18860)		
* 205	WK369400	PC SENSOR	P C セ ン サ ー			
210	--	MKH-D ASSEMBLY	M K H - D A s s ' y	(WD80060)		
210a	WD80100R	CIRCUIT BOARD	M K H - D シ ー ト			
210aa	WE623100	CIRCUIT BOARD	E M K S - F D シ ー ト			
210b	WB16880R	RUBBER CONTACTM	接 点 ゴ ム 1 2 K e y	C4#-C5,C5#-C6		04
220	--	MK61L ASSEMBLY	M K 6 1 L A s s ' y	(WD53540)		
220a	WD80010R	CIRCUIT BOARD	シ ー ト M K 6 1 L			
220b	WB16880R	RUBBER CONTACT	接 点 ゴ ム 1 2 K e y	C2#-C3,C3#-C4	2	04
220c	WB16890R	RUBBER CONTACT	接 点 ゴ ム 1 3 K e y	C1-C2		04
230	WF12750R	CABLE RELAY	中 継 カ ー ド 電 線			02
240	WE983200	BIND HEAD TAPPING SCREW-P	P タ イ ト + B I N D		7	01
250	WF266600	BIND HEAD TAPPING SCREW-P	P タ イ ト + B I N D		22	01
260	WE97440R	BIND HEAD TAPPING SCREW-P	P タ イ ト + B I N D		4	01
320	WM230500	GREASE	グ リ ス	(WC77150)		
330	--	GREASE	グ リ ス	(WG23930)		
400	WB1640A0	WHITE KEY OCTAVE SET	C,F/B,E/A/G/D		5	
400b	WB16680R	WHITE KEY ASSEMBLY C,F	白 鍵 O C T. セ ッ ト		2	03
400c	WB16690R	WHITE KEY ASSEMBLY B,E	白 鍵 A s s ' y C F		2	03
400d	WB16700R	WHITE KEY ASSEMBLY A	白 鍵 A s s ' y B E			03
400e	WB16710R	WHITE KEY ASSEMBLY G	白 鍵 A s s ' y A			03
400f	WB16720R	WHITE KEY ASSEMBLY D	白 鍵 A s s ' y G			03
			白 鍵 A s s ' y D			

*: New Parts

RANK: Japan only

WHEEL ASSEMBLY



REF NO.	PART NO.	DESCRIPTION		部 品 名	REMARKS	QTY	RANK
	--	WHEEL ASSEMBLY		ホイール A s s ' y	Tyros3		
	--	WHEEL ASSEMBLY		ホイール A s s ' y	(WN84220)		
* 10	WN842300	WHEEL FRAME		ホイールフレーム		2	
20	V457990R	WHEEL	EX	ホイール E X	PITCH BEND,MODULATION	2	04
30	VC79280R	SPRING		リターン S P			01
40	CB81902R	WHEEL TUBE		ホイールチューブ		2	04
50	EW60011R	STOPPER, CS-RING TYPE	12	C S 形 止 め 輪			01
60	VT69510R	ROTARY VARIABLE RESISTOR	SP. 10.0K RK163111	ロ ー タ リ ー V R	PITCH BEND,MODULATION	2	03
70	--	WIRING ASSEMBLY	WHEEL PH 4P-150,170	W H E E L 束 線	(WE84700)		
80	CB06925R	BINDING TIE	BK-1 (10pcs/pack)	インシュロックタイ		2	01
110	--	WIRE HARNESS BLACK		ビ ニ ー ル 線	(VK88170)		
120	--	WIRE HARNESS RED		ビ ニ ー ル 線	(VK88160)		

*: New Parts

RANK: Japan only

ELECTRICAL PARTS

AJK

REF NO.	PART NO.	DESCRIPTION	部 品 名	REMARKS	QTY	RANK
		ELECTRICAL PARTS	電 気 部 品	Tyros3		
*	WM198300	CIRCUIT BOARD	A J K シ ー ト	(WM18510)(X6041D0)		
*	WM199300	CIRCUIT BOARD	C K シ ー ト	(WM18500)(X6042C0)		
*	WM198200	CIRCUIT BOARD	D J K シ ー ト	(WM18500)(X6042C0)		
*	WM198900	CIRCUIT BOARD	H P シ ー ト	(WM18500)(X6042C0)		
*	WM199000	CIRCUIT BOARD	S P O L シ ー ト	(WM18500)(X6042C0)		
*	WM199200	CIRCUIT BOARD	S P O R シ ー ト	(WM18500)(X6042C0)		
*	WM154500	CIRCUIT BOARD	D M シ ー ト	(X9371C0)		
*	WK611800	CIRCUIT BOARD	E N シ ー ト	(WM24260)(X9411B0)		
*	WK611400	CIRCUIT BOARD	P N C シ ー ト	(WM24260)(X9411B0)		
*	WM840900	CIRCUIT BOARD	H D S B シ ー ト	(WM82880)(X6800B0)		
*	WK611500	CIRCUIT BOARD	L C L シ ー ト	(WM24270)(X9412C0)		
*	WK611600	CIRCUIT BOARD	L C R シ ー ト	(WM24270)(X9412C0)		
*	WM239800	CIRCUIT BOARD	M I C V R シ ー ト	(WM24250)(X9409C0)		
*	WK611300	CIRCUIT BOARD	P N L シ ー ト	(WM24250)(X9409C0)		
*	WK611900	CIRCUIT BOARD	P N L S シ ー ト	(WM24250)(X9409C0)		
*	WD80010R	CIRCUIT BOARD	シ ー ト M K 6 1 L	(WD80020)(X6578C0)		
*	WD80100R	CIRCUIT BOARD	M K H ー D シ ー ト	(WD78570)(X6579B0)		
*	WE623100	CIRCUIT BOARD	E M K S ー F D シ ー ト	(WE62270)(X6577A0)		
*	WK599200	CIRCUIT BOARD	P N R シ ー ト	(WM24240)(X9410C0)		
*	WK611700	CIRCUIT BOARD	U S B シ ー ト	(WM24240)(X9410C0)		
*	WM198300	CIRCUIT BOARD	A J K シ ー ト	(WM18510)(X6041D0)		
	--	JACK PLATE AML	J A C K 金 具 A M L	(WE80690)		
	--	AMR JACK PLATE	A M R J A C K 金 具	(WE81090)		
C1	US14510R	CERAMIC CAPACITOR-F (CHIP)	0.1000 25V Z RECT.	チ ッ プ セ ラ (F)		01
C2	US14510R	CERAMIC CAPACITOR-F (CHIP)	0.1000 25V Z RECT.	チ ッ プ セ ラ (F)		01
C3	UR839330	ELECTROLYTIC CAPACITOR	3300 16.0V RX TP	ケ ミ コ ン		01
C4	UR838100	ELECTROLYTIC CAPACITOR	100.00 16.0V RX TP	ケ ミ コ ン		
C5	US14510R	CERAMIC CAPACITOR-F (CHIP)	0.1000 25V Z RECT.	チ ッ プ セ ラ (F)		01
C9	US062220	CERAMIC CAPACITOR-SL (CHIP)	220P 50V J RECT.	チ ッ プ セ ラ (S L)		
C10	US062220	CERAMIC CAPACITOR-SL (CHIP)	220P 50V J RECT.	チ ッ プ セ ラ (S L)		
C12	UM416100	ELECTROLYTIC CAPACITOR	1.00 50.0V RX TP	ケ ミ コ ン		
C12	VB63980R	ELECTROLYTIC CAPACITOR	1.0 50.0V TATETE	ケ ミ コ ン 5 L		01
C12	WA67040R	ELECTROLYTIC CAPACITOR	1.00 50V TATETE-	ケ ミ コ ン		
C17	US06156R	CERAMIC CAPACITOR-CH (CHIP)	56P 50V J RECT.	チ ッ プ セ ラ (C H)		01
C18	UM416100	ELECTROLYTIC CAPACITOR	1.00 50.0V RX TP	ケ ミ コ ン		
C18	VB63980R	ELECTROLYTIC CAPACITOR	1.0 50.0V TATETE	ケ ミ コ ン 5 L		01
C18	WA67040R	ELECTROLYTIC CAPACITOR	1.00 50V TATETE	ケ ミ コ ン		
C19	US062220	CERAMIC CAPACITOR-SL (CHIP)	220P 50V J RECT.	チ ッ プ セ ラ (S L)		
C20	US062220	CERAMIC CAPACITOR-SL (CHIP)	220P 50V J RECT.	チ ッ プ セ ラ (S L)		
C22	UM416100	ELECTROLYTIC CAPACITOR	1.00 50.0V RX TP	ケ ミ コ ン		
C22	VB63980R	ELECTROLYTIC CAPACITOR	1.0 50.0V TATETE	ケ ミ コ ン 5 L		01
C22	WA67040R	ELECTROLYTIC CAPACITOR	1.00 50V TATETE	ケ ミ コ ン		
C27	US06156R	CERAMIC CAPACITOR-CH (CHIP)	56P 50V J RECT.	チ ッ プ セ ラ (C H)		01
C28	UM416100	ELECTROLYTIC CAPACITOR	1.00 50.0V RX TP	ケ ミ コ ン		
C28	VB63980R	ELECTROLYTIC CAPACITOR	1.0 50.0V TATETE	ケ ミ コ ン 5 L		01
C28	WA67040R	ELECTROLYTIC CAPACITOR	1.00 50V TATETE	ケ ミ コ ン		
C30	VB63970R	ELECTROLYTIC CAPACITOR-BP	4.7 25.0V TATETE	B P ケ ミ コ ン 5 L		01
C31	US06127R	CHIP MULTILAYER CERAMIC	27P 50V J RECT.	チ ッ プ セ ラ (C H)		01
C32	VB63970R	ELECTROLYTIC CAPACITOR-BP	4.7 25.0V TATETE	B P ケ ミ コ ン 5 L		01
C33	UM397470	ELECTROLYTIC CAPACITOR	47.00 16.0V RX TP	ケ ミ コ ン		
C33	VS49070R	ELECTROLYTIC CAPACITOR	47.0 16.0V TP	ケ ミ コ ン 5 L		01
C33	WA66840R	ELECTROLYTIC CAPACITOR	47.00 16V TATETE	ケ ミ コ ン		
C40	VB63970R	ELECTROLYTIC CAPACITOR-BP	4.7 25.0V TATETE	B P ケ ミ コ ン 5 L		01
C41	US06127R	CHIP MULTILAYER CERAMIC	27P 50V J RECT.	チ ッ プ セ ラ (C H)		01
C42	VB63970R	ELECTROLYTIC CAPACITOR-BP	4.7 25.0V TATETE	B P ケ ミ コ ン 5 L		01
C49	US06322R	CERAMIC CAPACITOR-B (CHIP)	2200P 50V K RECT.	チ ッ プ セ ラ (B)		01
C50	VB63970R	ELECTROLYTIC CAPACITOR-BP	4.7 25.0V TATETE	B P ケ ミ コ ン 5 L		01
C51	US061470	CERAMIC CAPACITOR-CH (CHIP)	47P 50V J RECT.	チ ッ プ セ ラ (C H)		
C52	VB63970R	ELECTROLYTIC CAPACITOR-BP	4.7 25.0V TATETE	B P ケ ミ コ ン 5 L		01
C53	US063100	CERAMIC CAPACITOR-B (CHIP)	1000P 50V K RECT.	チ ッ プ セ ラ (B)		
C54	UM397220	ELECTROLYTIC CAPACITOR	22.00 16.0V RX TP	ケ ミ コ ン		
C54	WA66820R	ELECTROLYTIC CAPACITOR	22.00 16V TATETE	ケ ミ コ ン		
C55	US14510R	CERAMIC CAPACITOR-F (CHIP)	0.1000 25V Z RECT.	チ ッ プ セ ラ (F)		01
C56	UM398100	ELECTROLYTIC CAPACITOR	100.00 16.0V RX TP	ケ ミ コ ン		
C56	WA66850R	ELECTROLYTIC CAPACITOR	100.00 16V TATETE	ケ ミ コ ン		01
C57	US06256R	CERAMIC CAPACITOR-SL (CHIP)	560P 50V J RECT.	チ ッ プ セ ラ (S L)		
C59	US06322R	CERAMIC CAPACITOR-B (CHIP)	2200P 50V K RECT.	チ ッ プ セ ラ (B)		01
C60	VB63970R	ELECTROLYTIC CAPACITOR-BP	4.7 25.0V TATETE	B P ケ ミ コ ン 5 L		01

*: New Parts

RANK: Japan only

AJK

REF NO.	PART NO.	DESCRIPTION	部 品 名	REMARKS	QTY	RANK
C61	US061470	CERAMIC CAPACITOR-CH (CHIP)	47P 50V J RECT.	チップセラ (C H)		
C62	VB63970R	ELECTROLYTIC CAPACITOR-BP	4.7 25.0V TATETE	B P ケ ミ コ ン 5 L		01
C63	US063100	CERAMIC CAPACITOR-B (CHIP)	1000P 50V K RECT.	チップセラ (B)		
C67	US06256R	CERAMIC CAPACITOR-SL (CHIP)	560P 50V J RECT.	チップセラ (S L)		
C70	VB63970R	ELECTROLYTIC CAPACITOR-BP	4.7 25.0V TATETE	B P ケ ミ コ ン 5 L		01
C71	US06212R	CERAMIC CAPACITOR-SL (CHIP)	120P 50V J RECT.	チップセラ (S L)		01
C72	US14510R	CERAMIC CAPACITOR-F (CHIP)	0.1000 25V Z RECT.	チップセラ (F)		01
C73	UN848100	ELECTROLYTIC CAPACITOR-BP	100.00 25.0V RX TP	B P ケ ミ コ ン		01
C79	US062100	CERAMIC CAPACITOR-SL (CHIP)	100P 50V J RECT.	チップセラ (S L)		
C80	VB63970R	ELECTROLYTIC CAPACITOR-BP	4.7 25.0V TATETE	B P ケ ミ コ ン 5 L		01
C81	US06212R	CERAMIC CAPACITOR-SL (CHIP)	120P 50V J RECT.	チップセラ (S L)		01
C82	US14510R	CERAMIC CAPACITOR-F (CHIP)	0.1000 25V Z RECT.	チップセラ (F)		01
C83	UN848100	ELECTROLYTIC CAPACITOR-BP	100.00 25.0V RX TP	B P ケ ミ コ ン		01
C89	US062100	CERAMIC CAPACITOR-SL (CHIP)	100P 50V J RECT.	チップセラ (S L)		
C90	US14510R	CERAMIC CAPACITOR-F (CHIP)	0.1000 25V Z RECT.	チップセラ (F)		01
C91	UR865330	ELECTROLYTIC CAPACITOR	0.33 50.0V RX TP	ケ ミ コ ン		01
C92	UR848220	ELECTROLYTIC CAPACITOR	220.00 25.0V RX TP	ケ ミ コ ン		
C93	US14510R	CERAMIC CAPACITOR-F (CHIP)	0.1000 25V Z RECT.	チップセラ (F)		01
C110	VB63970R	ELECTROLYTIC CAPACITOR-BP	4.7 25.0V TATETE	B P ケ ミ コ ン 5 L		01
C111	US062100	CERAMIC CAPACITOR-SL (CHIP)	100P 50V J RECT.	チップセラ (S L)		
C112	VB63990R	ELECTROLYTIC CAPACITOR	4.7 50.0V TATETE	ケ ミ コ ン 5 L		
C113	US063100	CERAMIC CAPACITOR-B (CHIP)	1000P 50V K RECT.	チップセラ (B)		
C114	US063100	CERAMIC CAPACITOR-B (CHIP)	1000P 50V K RECT.	チップセラ (B)		
C115	VB63970R	ELECTROLYTIC CAPACITOR-BP	4.7 25.0V TATETE	B P ケ ミ コ ン 5 L		01
C120	VB63970R	ELECTROLYTIC CAPACITOR-BP	4.7 25.0V TATETE	B P ケ ミ コ ン 5 L		01
C121	US062100	CERAMIC CAPACITOR-SL (CHIP)	100P 50V J RECT.	チップセラ (S L)		
C122	VB63990R	ELECTROLYTIC CAPACITOR	4.7 50.0V TATETE	ケ ミ コ ン 5 L		
C123	US063100	CERAMIC CAPACITOR-B (CHIP)	1000P 50V K RECT.	チップセラ (B)		
C124	US063100	CERAMIC CAPACITOR-B (CHIP)	1000P 50V K RECT.	チップセラ (B)		
C125	VB63970R	ELECTROLYTIC CAPACITOR-BP	4.7 25.0V TATETE	B P ケ ミ コ ン 5 L		01
C130	VB63970R	ELECTROLYTIC CAPACITOR-BP	4.7 25.0V TATETE	B P ケ ミ コ ン 5 L		01
C131	US06156R	CERAMIC CAPACITOR-CH (CHIP)	56P 50V J RECT.	チップセラ (C H)		01
C132	VB63990R	ELECTROLYTIC CAPACITOR	4.7 50.0V TATETE	ケ ミ コ ン 5 L		
C133	US063100	CERAMIC CAPACITOR-B (CHIP)	1000P 50V K RECT.	チップセラ (B)		
C140	VB63970R	ELECTROLYTIC CAPACITOR-BP	4.7 25.0V TATETE	B P ケ ミ コ ン 5 L		01
C141	US06156R	CERAMIC CAPACITOR-CH (CHIP)	56P 50V J RECT.	チップセラ (C H)		01
C142	VB63990R	ELECTROLYTIC CAPACITOR	4.7 50.0V TATETE	ケ ミ コ ン 5 L		
C143	US063100	CERAMIC CAPACITOR-B (CHIP)	1000P 50V K RECT.	チップセラ (B)		
C150	US063100	CERAMIC CAPACITOR-B (CHIP)	1000P 50V K RECT.	チップセラ (B)		
C152	VB63990R	ELECTROLYTIC CAPACITOR	4.7 50.0V TATETE	ケ ミ コ ン 5 L		
C160	US063100	CERAMIC CAPACITOR-B (CHIP)	1000P 50V K RECT.	チップセラ (B)		
C162	VB63990R	ELECTROLYTIC CAPACITOR	4.7 50.0V TATETE	ケ ミ コ ン 5 L		
C201	US14510R	CERAMIC CAPACITOR-F (CHIP)	0.1000 25V Z RECT.	チップセラ (F)		01
C202	US14510R	CERAMIC CAPACITOR-F (CHIP)	0.1000 25V Z RECT.	チップセラ (F)		01
C216	US062100	CERAMIC CAPACITOR-SL (CHIP)	100P 50V J RECT.	チップセラ (S L)		
C217	UM397470	ELECTROLYTIC CAPACITOR	47.00 16.0V RX TP	ケ ミ コ ン		
C217	VS49070R	ELECTROLYTIC CAPACITOR	47.0 16.0V TP	ケ ミ コ ン 5 L		01
C217	WA66840R	ELECTROLYTIC CAPACITOR	47.00 16V TATETE	ケ ミ コ ン		
C226	US062100	CERAMIC CAPACITOR-SL (CHIP)	100P 50V J RECT.	チップセラ (S L)		
C227	UM397470	ELECTROLYTIC CAPACITOR	47.00 16.0V RX TP	ケ ミ コ ン		
C227	VS49070R	ELECTROLYTIC CAPACITOR	47.0 16.0V TP	ケ ミ コ ン 5 L		01
C227	WA66840R	ELECTROLYTIC CAPACITOR	47.00 16V TATETE	ケ ミ コ ン		
C231	US063100	CERAMIC CAPACITOR-B (CHIP)	1000P 50V K RECT.	チップセラ (B)		
C241	US063100	CERAMIC CAPACITOR-B (CHIP)	1000P 50V K RECT.	チップセラ (B)		
C264	US14510R	CERAMIC CAPACITOR-F (CHIP)	0.1000 25V Z RECT.	チップセラ (F)		01
C271	US14510R	CERAMIC CAPACITOR-F (CHIP)	0.1000 25V Z RECT.	チップセラ (F)		01
C282	US14510R	CERAMIC CAPACITOR-F (CHIP)	0.1000 25V Z RECT.	チップセラ (F)		01
C291	US14510R	CERAMIC CAPACITOR-F (CHIP)	0.1000 25V Z RECT.	チップセラ (F)		01
C300	US14510R	CERAMIC CAPACITOR-F (CHIP)	0.1000 25V Z RECT.	チップセラ (F)		01
C301	UM416100	ELECTROLYTIC CAPACITOR	1.00 50.0V RX TP	ケ ミ コ ン		
C301	VB63980R	ELECTROLYTIC CAPACITOR	1.0 50.0V TATETE	ケ ミ コ ン 5 L		01
C301	WA67040R	ELECTROLYTIC CAPACITOR	1.00 50V TATETE	ケ ミ コ ン		
C302	UM416100	ELECTROLYTIC CAPACITOR	1.00 50.0V RX TP	ケ ミ コ ン		
C302	VB63980R	ELECTROLYTIC CAPACITOR	1.0 50.0V TATETE	ケ ミ コ ン 5 L		01
C302	WA67040R	ELECTROLYTIC CAPACITOR	1.00 50V TATETE-	ケ ミ コ ン		
C303	UM397220	ELECTROLYTIC CAPACITOR	22.00 16.0V RX TP	ケ ミ コ ン		
C303	WA66820R	ELECTROLYTIC CAPACITOR	22.00 16V TATETE	ケ ミ コ ン		
C304	UR865470	ELECTROLYTIC CAPACITOR	0.47 50.0V RX TP	ケ ミ コ ン		
C305	US14510R	CERAMIC CAPACITOR-F (CHIP)	0.1000 25V Z RECT.	チップセラ (F)		01
C312	US14510R	CERAMIC CAPACITOR-F (CHIP)	0.1000 25V Z RECT.	チップセラ (F)		01

*: New Parts

RANK: Japan only

AJK

REF NO.	PART NO.	DESCRIPTION		部 品 名	REMARKS	QTY	RANK
C322	US14510R	CERAMIC CAPACITOR-F (CHIP)	0.1000 25V Z RECT.	チ ッ プ セ ラ (F)			01
C333	US14510R	CERAMIC CAPACITOR-F (CHIP)	0.1000 25V Z RECT.	チ ッ プ セ ラ (F)			01
C343	US14510R	CERAMIC CAPACITOR-F (CHIP)	0.1000 25V Z RECT.	チ ッ プ セ ラ (F)			01
C361	US063100	CERAMIC CAPACITOR-B (CHIP)	1000P 50V K RECT.	チ ッ プ セ ラ (B)			
C362	US063100	CERAMIC CAPACITOR-B (CHIP)	1000P 50V K RECT.	チ ッ プ セ ラ (B)			
C401	US14510R	CERAMIC CAPACITOR-F (CHIP)	0.1000 25V Z RECT.	チ ッ プ セ ラ (F)			01
C402	US14510R	CERAMIC CAPACITOR-F (CHIP)	0.1000 25V Z RECT.	チ ッ プ セ ラ (F)			01
C501	US14510R	CERAMIC CAPACITOR-F (CHIP)	0.1000 25V Z RECT.	チ ッ プ セ ラ (F)			01
C502	US14510R	CERAMIC CAPACITOR-F (CHIP)	0.1000 25V Z RECT.	チ ッ プ セ ラ (F)			01
C601	US14510R	CERAMIC CAPACITOR-F (CHIP)	0.1000 25V Z RECT.	チ ッ プ セ ラ (F)			01
C602	US14510R	CERAMIC CAPACITOR-F (CHIP)	0.1000 25V Z RECT.	チ ッ プ セ ラ (F)			01
C701	US14510R	CERAMIC CAPACITOR-F (CHIP)	0.1000 25V Z RECT.	チ ッ プ セ ラ (F)			01
C702	US14510R	CERAMIC CAPACITOR-F (CHIP)	0.1000 25V Z RECT.	チ ッ プ セ ラ (F)			01
C801	US14510R	CERAMIC CAPACITOR-F (CHIP)	0.1000 25V Z RECT.	チ ッ プ セ ラ (F)			01
C802	US14510R	CERAMIC CAPACITOR-F (CHIP)	0.1000 25V Z RECT.	チ ッ プ セ ラ (F)			01
CN1	VZ479500	CONNECTOR BASE PIN	52806 24P TE	F F C コ ネ ク タ ー			
CN2	LB93203R	CONNECTOR	VH 3P TE	ベ ー ス ポ ス ト			01
CN3	VB39070R	CONNECTOR	PH 11P TE EH TYPE	ベ ー ス ポ ス ト			01
CN5	LB93203R	CONNECTOR	VH 3P TE	ベ ー ス ポ ス ト			01
CN6	VB390200	CONNECTOR	PH 6P TE	ベ ー ス ポ ス ト			
CN7	VB390200	CONNECTOR	PH 6P TE	ベ ー ス ポ ス ト			
D1	VR49650R	DIODE	MA2J1110GL TP	チ ッ プ ダイ オ ー ド			01
-12	VR49650R	DIODE	MA2J1110GL TP	チ ッ プ ダイ オ ー ド			01
D1	VT332900	DIODE	1SS355 TE-17 TP	ダイ オ ー ド			
-12	VT332900	DIODE	1SS355 TE-17 TP	ダイ オ ー ド			
D1	WG139300	DIODE	KDS4148U-RTK/P TE	ダイ オ ー ド			
-12	WG139300	DIODE	KDS4148U-RTK/P TE	ダイ オ ー ド			
D21	VR49650R	DIODE	MA2J1110GL TP	チ ッ プ ダイ オ ー ド			01
D21	VT332900	DIODE	1SS355 TE-17 TP	ダイ オ ー ド			
D21	WG139300	DIODE	KDS4148U-RTK/P TE	ダイ オ ー ド			
D22	VR49650R	DIODE	MA2J1110GL TP	チ ッ プ ダイ オ ー ド			01
D22	VT332900	DIODE	1SS355 TE-17 TP	ダイ オ ー ド			
D22	WG139300	DIODE	KDS4148U-RTK/P TE	ダイ オ ー ド			
EM1	VI243100	EMI FILTER	DSS6NB32A271Q93A	L C フィ ル タ ー			01
-6	VI243100	EMI FILTER	DSS6NB32A271Q93A	L C フィ ル タ ー			01
FT3	IE10262R	FET	2SK246-Y(TPE2,F)	F E T			01
FT4	IE10262R	FET	2SK246-Y(TPE2,F)	F E T			01
IC2	X2331A0R	IC	NJM4580E(TE2)	I C	OP AMP		01
IC3	XE470A0R	IC	M51132L	I C	VCA		04
IC4	X3505A00	IC	NJM2068M-D(TE2)	I C	OP AMP		
IC5	X3505A00	IC	NJM2068M-D(TE2)	I C	OP AMP		
IC6	XT131A0R	IC	LA6517M-TRM-E-R	I C	OPRATIONAL POWER AMP		
IC7	X3505A00	IC	NJM2068M-D(TE2)	I C	OP AMP		
IC8	X3505A00	IC	NJM2068M-D(TE2)	I C	OP AMP		
JK1	LB101870	HEADPHONE JACK	YKB21-5006	ホ ー ン コ ネ ク タ	LINE IN/MIC [L/L+R/MIC]		03
JK2	LB101870	HEADPHONE JACK	YKB21-5006	ホ ー ン コ ネ ク タ	LINE IN/MIC [R]		03
JK3	VB312600	PHONE JACK BLACK	YKB21-5012	ホ ー ン コ ネ ク タ (黒)	TO SUB WOOFER [L]		02
JK5	VV881001	DIN JACK	8P CMS5008-0101F	丸 形 ミ ニ チャ ー コ ネ ク タ	TO SUB WOOFER [R]		
JK6	LB101870	HEADPHONE JACK	YKB21-5006	ホ ー ン コ ネ ク タ	AUX OUT/LOOP SEND [L/L+R]		03
JK7	VB312600	PHONE JACK BLACK	YKB21-5012	ホ ー ン コ ネ ク タ (黒)	AUX OUT/LOOP SEND [R]		02
JK8	VB312600	PHONE JACK BLACK	YKB21-5012	ホ ー ン コ ネ ク タ (黒)	AUX IN/LOOP RETURN [L/L+R]		02
JK9	LB101870	HEADPHONE JACK	YKB21-5006	ホ ー ン コ ネ ク タ	AUX IN/LOOP RETURN [R]		03
JK10	VC68750R	PHONE JACK BLACK	YKB21-5014	ホ ー ン コ ネ ク タ (黒)	LINE OUT MAIN [L/L+R]		01
JK11	VB312600	PHONE JACK BLACK	YKB21-5012	ホ ー ン コ ネ ク タ (黒)	LINE OUT MAIN [R]		02
JK12	LB101870	HEADPHONE JACK	YKB21-5006	ホ ー ン コ ネ ク タ	LINE OUT SUB [1]		03
JK13	LB101870	HEADPHONE JACK	YKB21-5006	ホ ー ン コ ネ ク タ	LINE OUT SUB [2]		03
L3	VY65720R	CHIP INDUCTANCE	600 BK1608HM601-T	チ ッ プ イ ン ダ ク タ			01
-8	VY65720R	CHIP INDUCTANCE	600 BK1608HM601-T	チ ッ プ イ ン ダ ク タ			01
L10	VY65720R	CHIP INDUCTANCE	600 BK1608HM601-T	チ ッ プ イ ン ダ ク タ			01
-14	VY65720R	CHIP INDUCTANCE	600 BK1608HM601-T	チ ッ プ イ ン ダ ク タ			01
L15	GE300670	FERRIT BEAD	BL02RN2R1P1A TATET	フ ェ ラ イ ト ビ ー ズ			02
L16	VY65720R	CHIP INDUCTANCE	600 BK1608HM601-T	チ ッ プ イ ン ダ ク タ			01
-19	VY65720R	CHIP INDUCTANCE	600 BK1608HM601-T	チ ッ プ イ ン ダ ク タ			01
L20	VF45660R	COIL	SBT-0180W RX 80uH	コ イ ル 8 0 U			03
L22	VF45660R	COIL	SBT-0180W RX 80uH	コ イ ル 8 0 U			03
L24	GE300670	FERRIT BEAD	BL02RN2R1P1A TATET	フ ェ ラ イ ト ビ ー ズ			02
L25	GE300670	FERRIT BEAD	BL02RN2R1P1A TATET	フ ェ ラ イ ト ビ ー ズ			02
L27	GE300670	FERRIT BEAD	BL02RN2R1P1A TATET	フ ェ ラ イ ト ビ ー ズ			02
L28	VY65720R	CHIP INDUCTANCE	600 BK1608HM601-T	チ ッ プ イ ン ダ ク タ			01
-30	VY65720R	CHIP INDUCTANCE	600 BK1608HM601-T	チ ッ プ イ ン ダ ク タ			01

*: New Parts

RANK: Japan only



AJK

REF NO.	PART NO.	DESCRIPTION		部 品 名	REMARKS	QTY	RANK
L31	GE300670	FERRIT BEAD	BL02RN2R1P1A TATET	フェライトビーズ			02
L32	VY65720R	CHIP INDUCTANCE	600 BK1608HM601-T	チップインダクタ			01
L33	VY65720R	CHIP INDUCTANCE	600 BK1608HM601-T	チップインダクタ			01
L34	GE300670	FERRIT BEAD	BL02RN2R1P1A TATET	フェライトビーズ			02
L35	VY65720R	CHIP INDUCTANCE	600 BK1608HM601-T	チップインダクタ			01
L36	--	JUMPER CABLE	0.55	ジャンパー線	(VA07890)		
L37	--	JUMPER CABLE	0.55	ジャンパー線	(VA07890)		
L40	VF45660R	COIL	SBT-0180W RX 80uH	コイル 80U			03
-47	VF45660R	COIL	SBT-0180W RX 80uH	コイル 80U			03
L49	GE300670	FERRIT BEAD	BL02RN2R1P1A TATET	フェライトビーズ			02
-51	GE300670	FERRIT BEAD	BL02RN2R1P1A TATET	フェライトビーズ			02
L54	--	JUMPER CABLE	0.55	ジャンパー線	(VA07890)		
L55	--	JUMPER CABLE	0.55	ジャンパー線	(VA07890)		
L57	VQ72490R	CHIP INDUCTANCE	BK212 5HM601-T	チップインダクタ			01
L58	GE300670	FERRIT BEAD	BL02RN2R1P1A TATET	フェライトビーズ			02
L59	VQ72490R	CHIP INDUCTANCE	BK212 5HM601-T	チップインダクタ			01
L60	VQ72490R	CHIP INDUCTANCE	BK212 5HM601-T	チップインダクタ			01
L61	GE300670	FERRIT BEAD	BL02RN2R1P1A TATET	フェライトビーズ			02
L62	VB835000	COIL	FL05RD200AT TE 20uH	コイル 20U			01
-64	VB835000	COIL	FL05RD200AT TE 20uH	コイル 20U			01
R10	RD35747R	CHIP RESISTOR 1/16W	47.0K 63M J RECT.	チップ抵抗			01
R11	RD357220	CHIP RESISTOR 1/16W	22.0K 63M J RECT.	チップ抵抗			01
R12	RD350001	CHIP RESISTOR 1/16W	0 63M J RECT.	チップ抵抗			01
R13	RD350001	CHIP RESISTOR 1/16W	0 63M J RECT.	チップ抵抗			01
R14	RD355560	CHIP RESISTOR 1/16W	560.0 63M J RECT.	チップ抵抗			01
R17	RD355220	CHIP RESISTOR 1/16W	220.0 63M J RECT.	チップ抵抗			01
R20	RD35747R	CHIP RESISTOR 1/16W	47.0K 63M J RECT.	チップ抵抗			01
R21	RD357220	CHIP RESISTOR 1/16W	22.0K 63M J RECT.	チップ抵抗			01
R22	RD350001	CHIP RESISTOR 1/16W	0 63M J RECT.	チップ抵抗			01
R23	RD350001	CHIP RESISTOR 1/16W	0 63M J RECT.	チップ抵抗			01
R24	RD355560	CHIP RESISTOR 1/16W	560.0 63M J RECT.	チップ抵抗			01
R27	RD355220	CHIP RESISTOR 1/16W	220.0 63M J RECT.	チップ抵抗			01
R30	RD357330	CHIP RESISTOR 1/16W	33.0K 63M J RECT.	チップ抵抗			01
R31	RD357820	CHIP RESISTOR 1/16W	82.0K 63M J RECT.	チップ抵抗			01
R32	RD358560	CHIP RESISTOR 1/16W	560.0K 63M J RECT.	チップ抵抗			01
R33	RD357100	CHIP RESISTOR 1/16W	10.0K 63M J RECT.	チップ抵抗			01
R34	RD357100	CHIP RESISTOR 1/16W	10.0K 63M J RECT.	チップ抵抗			01
R35	RD357820	CHIP RESISTOR 1/16W	82.0K 63M J RECT.	チップ抵抗			01
R36	RD355100	CHIP RESISTOR 1/16W	100.0 63M J RECT.	チップ抵抗			01
R37	RD357270	CHIP RESISTOR 1/16W	27.0K 63M J RECT.	チップ抵抗			01
R38	RD35747R	CHIP RESISTOR 1/16W	47.0K 63M J RECT.	チップ抵抗			01
R39	RD356470	CHIP RESISTOR 1/16W	4.7K 63M J RECT.	チップ抵抗			01
R40	RD357330	CHIP RESISTOR 1/16W	33.0K 63M J RECT.	チップ抵抗			01
R41	RD357820	CHIP RESISTOR 1/16W	82.0K 63M J RECT.	チップ抵抗			01
R42	RD358560	CHIP RESISTOR 1/16W	560.0K 63M J RECT.	チップ抵抗			01
R43	RD357100	CHIP RESISTOR 1/16W	10.0K 63M J RECT.	チップ抵抗			01
R44	RD357100	CHIP RESISTOR 1/16W	10.0K 63M J RECT.	チップ抵抗			01
R45	RD357820	CHIP RESISTOR 1/16W	82.0K 63M J RECT.	チップ抵抗			01
R46	RD355100	CHIP RESISTOR 1/16W	100.0 63M J RECT.	チップ抵抗			01
R47	RD358560	CHIP RESISTOR 1/16W	560.0K 63M J RECT.	チップ抵抗			01
R50	RD357150	CHIP RESISTOR 1/16W	15.0K 63M J RECT.	チップ抵抗			01
R51	RD357270	CHIP RESISTOR 1/16W	27.0K 63M J RECT.	チップ抵抗			01
R52	RD357100	CHIP RESISTOR 1/16W	10.0K 63M J RECT.	チップ抵抗			01
R53	RD15522R	CARBON RESISTOR (CHIP)	220.0 1/4 J TP	チップ抵抗			01
R54	RD356220	CHIP RESISTOR 1/16W	2.2K 63M J RECT.	チップ抵抗			01
R55	RD357100	CHIP RESISTOR 1/16W	10.0K 63M J RECT.	チップ抵抗			01
R56	RD357100	CHIP RESISTOR 1/16W	10.0K 63M J RECT.	チップ抵抗			01
R57	RD356470	CHIP RESISTOR 1/16W	4.7K 63M J RECT.	チップ抵抗			01
R58	RD357100	CHIP RESISTOR 1/16W	10.0K 63M J RECT.	チップ抵抗			01
R59	RD357100	CHIP RESISTOR 1/16W	10.0K 63M J RECT.	チップ抵抗			01
R60	RD357150	CHIP RESISTOR 1/16W	15.0K 63M J RECT.	チップ抵抗			01
R61	RD357270	CHIP RESISTOR 1/16W	27.0K 63M J RECT.	チップ抵抗			01
R62	RD357100	CHIP RESISTOR 1/16W	10.0K 63M J RECT.	チップ抵抗			01
R63	RD15522R	CARBON RESISTOR (CHIP)	220.0 1/4 J TP	チップ抵抗			01
R64	RD356220	CHIP RESISTOR 1/16W	2.2K 63M J RECT.	チップ抵抗			01
R65	RD357100	CHIP RESISTOR 1/16W	10.0K 63M J RECT.	チップ抵抗			01
R66	RD355150	CHIP RESISTOR 1/16W	150.0 63M J RECT.	チップ抵抗			01
R67	RD357100	CHIP RESISTOR 1/16W	10.0K 63M J RECT.	チップ抵抗			01
R68	RD357120	CHIP RESISTOR 1/16W	12.0K 63M J RECT.	チップ抵抗			01
R69	RD15510R	CARBON RESISTOR (CHIP)	100.0 1/4 J TP	チップ抵抗			01

*: New Parts

RANK: Japan only

AJK and CK/DJK/HP/SPOL/SPOR

REF NO.	PART NO.	DESCRIPTION		部 品 名	REMARKS	QTY	RANK
R304	RD350001	CHIP RESISTOR 1/16W	0 63M J RECT.	チ ッ プ 抵 抗			01
R310	RD350001	CHIP RESISTOR 1/16W	0 63M J RECT.	チ ッ プ 抵 抗			01
R320	RD350001	CHIP RESISTOR 1/16W	0 63M J RECT.	チ ッ プ 抵 抗			01
R351	RD350001	CHIP RESISTOR 1/16W	0 63M J RECT.	チ ッ プ 抵 抗			01
R352	RD350001	CHIP RESISTOR 1/16W	0 63M J RECT.	チ ッ プ 抵 抗			01
R360	RD150000	CARBON RESISTOR (CHIP)	0.0 1/4 J TP	チ ッ プ 抵 抗			01
R361	RD15433R	CARBON RESISTOR (CHIP)	33.0 1/4 J TP	チ ッ プ 抵 抗			01
R362	RD15433R	CARBON RESISTOR (CHIP)	33.0 1/4 J TP	チ ッ プ 抵 抗			01
R365	RD150000	CARBON RESISTOR (CHIP)	0.0 1/4 J TP	チ ッ プ 抵 抗			01
R366	RD150000	CARBON RESISTOR (CHIP)	0.0 1/4 J TP	チ ッ プ 抵 抗			01
RY1	V824560R	RELAY	DC ATX203 12V	リ レ			04
RY1	WB751900	RELAY	DC EC2-12NU-F 12V	リ レ - 1 2 V			
TR1	VV556400	TRANSISTOR	2SC2412K Q,R,S TP	ト ラ ン ジ ス タ			
-4	VV556400	TRANSISTOR	2SC2412K Q,R,S TP	ト ラ ン ジ ス タ			
TR1	WC52940R	TRANSISTOR	KTC3875S-Y	ト ラ ン ジ ス タ			01
-4	WC52940R	TRANSISTOR	KTC3875S-Y	ト ラ ン ジ ス タ			01
TR5	WC883400	TRANSISTOR	2SD2704 K TP	ト ラ ン ジ ス タ			
TR6	WC883400	TRANSISTOR	2SD2704 K TP	ト ラ ン ジ ス タ			
TR7	VV556400	TRANSISTOR	2SC2412K Q,R,S TP	ト ラ ン ジ ス タ			
TR7	WC52940R	TRANSISTOR	2SC KTC3875S-Y	ト ラ ン ジ ス タ			01
TR8	VJ92720R	TRANSISTOR	2SA1162-Y(TE85R,F)	ト ラ ン ジ ス タ			01
TR8	VV556500	TRANSISTOR	2SA1037AK Q,R,S TP	ト ラ ン ジ ス タ			
TR8	WC52950R	TRANSISTOR	KTA1504S-Y	ト ラ ン ジ ス タ			
TR9	VV556400	TRANSISTOR	2SC2412K Q,R,S TP	ト ラ ン ジ ス タ			
TR9	WC52940R	TRANSISTOR	KTC3875S-Y	ト ラ ン ジ ス タ			01
TR10	VV556400	TRANSISTOR	2SC2412K Q,R,S TP	ト ラ ン ジ ス タ			
TR10	WC52940R	TRANSISTOR	KTC3875S-Y	ト ラ ン ジ ス タ			01
TR11	WC883400	TRANSISTOR	2SD2704 K TP	ト ラ ン ジ ス タ			
-16	WC883400	TRANSISTOR	2SD2704 K TP	ト ラ ン ジ ス タ			
TR17	VJ92720R	TRANSISTOR	2SA1162-Y(TE85R,F)	ト ラ ン ジ ス タ			01
TR17	VV556500	TRANSISTOR	2SA1037AK Q,R,S TP	ト ラ ン ジ ス タ			
TR17	WC52950R	TRANSISTOR	KTA1504S-Y	ト ラ ン ジ ス タ			
VR1	WG13900R	ROTARY VARIABLE RESISTOR	A 50.0K RK12L12A0C	二 連 ロ ー タ リ ー V R	AUX IN/LOOP RETURN [TRIM]		02
VR2	VV04920R	ROTARY VARIABLE RESISTOR	B 10K RK09K12A	二 連 ロ ー タ リ ー V R	LINE IN/MIC [TRIM]		03
W1	--	WIRING ASSEMBLY	SPL VH-VH 2P-250	S P L 束 線	(WE84550)		
W3	--	WIRING ASSEMBLY	GND3 LUG-PIN L=130	G N D 3 束 線	(WN89510)		
ZD1	VU172800	ZENER DIODE	UDZS12B TE-17 12V	ツ ェ ナ ー ダイ オ ード			01
*	WM199300	CIRCUIT BOARD	CK	C K シ ー ト	(WM18500)(X6042C0)		
*	WM198200	CIRCUIT BOARD	DJK	D J K シ ー ト	(WM18500)(X6042C0)		
*	WM198900	CIRCUIT BOARD	HP	H P シ ー ト	(WM18500)(X6042C0)		
*	WM199000	CIRCUIT BOARD	SPOL	S P O L シ ー ト	(WM18500)(X6042C0)		
*	WM199200	CIRCUIT BOARD	SPOR	S P O R シ ー ト	(WM18500)(X6042C0)		
	--	JUMPER CABLE	0.55	ジ ャ ン パ ー 線	(VA07890)		
	--	SP JACK PLATE		S P J A C K 金 具	(WE81080)	2	
	--	DML JACK PLATE		D M L J A C K 金 具	(WE81100)		
	--	DMR JACK PLATE		D M R J A C K 金 具	(WE81110)		
	WE774301	BIND HEAD TAPPING SCREW-B	3.0X8 MFZN2W3	B タ イ ト + B I N D			
C13	FG64410R	CERAMIC CAPACITOR-F	0.0100 50V Z RX TP	セ ラ コ ン (F)			01
C14	US062220	CERAMIC CAPACITOR-SL (CHIP)	220P 50V J RECT.	チ ッ プ セ ラ (S L)			
C23	FG64410R	CERAMIC CAPACITOR-F	0.0100 50V Z RX TP	セ ラ コ ン (F)			01
C24	US062220	CERAMIC CAPACITOR-SL (CHIP)	220P 50V J RECT.	チ ッ プ セ ラ (S L)			
C33	FG64410R	CERAMIC CAPACITOR-F	0.0100 50V Z RX TP	セ ラ コ ン (F)			01
C34	US062220	CERAMIC CAPACITOR-SL (CHIP)	220P 50V J RECT.	チ ッ プ セ ラ (S L)			
C40	FG64410R	CERAMIC CAPACITOR-F	0.0100 50V Z RX TP	セ ラ コ ン (F)			01
C43	FG64410R	CERAMIC CAPACITOR-F	0.0100 50V Z RX TP	セ ラ コ ン (F)			01
C50	FG64410R	CERAMIC CAPACITOR-F	0.0100 50V Z RX TP	セ ラ コ ン (F)			01
C53	FG64410R	CERAMIC CAPACITOR-F	0.0100 50V Z RX TP	セ ラ コ ン (F)			01
C86	FG613100	CERAMIC CAPACITOR-B	1000P 50V K RX TP	セ ラ コ ン (B)			
C87	UR838220	ELECTROLYTIC CAPACITOR	220.00 16.0V RX TP	ケ ミ コ ン			
C95	WB47690R	ELECTROLYTIC CAPACITOR-ZL	470.00 16.0V RX TP	ケ ミ コ ン Z L			01
C96	US065100	CERAMIC CAPACITOR-F (CHIP)	0.100 50V Z RECT.	チ ッ プ セ ラ F			
C98	US065100	CERAMIC CAPACITOR-F (CHIP)	0.100 50V Z RECT.	チ ッ プ セ ラ F			
C99	WB47690R	ELECTROLYTIC CAPACITOR-ZL	470.00 16.0V RX TP	ケ ミ コ ン Z L			01
C102	FG64410R	CERAMIC CAPACITOR-F	0.0100 50V Z RX TP	セ ラ コ ン (F)			01
C103	FG64410R	CERAMIC CAPACITOR-F	0.0100 50V Z RX TP	セ ラ コ ン (F)			01
C104	US062220	CERAMIC CAPACITOR-SL (CHIP)	220P 50V J RECT.	チ ッ プ セ ラ (S L)			
C105	US062220	CERAMIC CAPACITOR-SL (CHIP)	220P 50V J RECT.	チ ッ プ セ ラ (S L)			
CN10	V768700R	FFC CONNECTOR	52806 17P TE	F F C コ ネ ク タ			01
CN80	VB39080R	CONNECTOR	PH 12P TE EH TYPE	ベ ー ス ポ ス ト			01

*: New Parts

RANK: Japan only

CK/DJK/HP/SPOL/SPOR

REF NO.	PART NO.	DESCRIPTION	部 品 名	REMARKS	QTY	RANK
CN81	V6706500	D-SUB CONNECTOR	KH 15P SE	D - S u b コネクタ		05
CN91	LB918060	BASE PIN	XH 6P TE I-TYPE	ベースツキポスト	RGB OUT	
CN92	VB39010R	CONNECTOR	PH 5P TE	ベースポスト		01
CN100	VB858500	BASE PIN	PH 6P SE	ベースポスト		
CN302	LB93303R	BASE POST CONNECTOR	VH 3P SE	ベースポスト		01
CN303	LB933020	CONNECTOR	VH 2P SE	ベースポスト		
D4	VB941200	DIODE	1SS133,1SS176 TE	ダイオード		
D5	VB941200	DIODE	1SS133,1SS176 TE	ダイオード		
D10	VR49650R	DIODE	MA2J1110GL TP	チップダイオード		01
-18	VR49650R	DIODE	MA2J1110GL TP	チップダイオード		01
D10	VT332900	DIODE	1SS355 TE-17 TP	ダイオード		
-18	VT332900	DIODE	1SS355 TE-17 TP	ダイオード		
EM11	VI243100	EMI FILTER	DSS6NB32A271Q93A	L C フィルター		01
EM12	VI243100	EMI FILTER	DSS6NB32A271Q93A	L C フィルター		01
IC40	VD47320R	IC PHOTO COUPLER	6N137-000E	フォトカプラ		05
IC50	VD47320R	IC PHOTO COUPLER	6N137-000E	フォトカプラ		05
J60	--	JUMPER CABLE	0.55	ジャンパー線	(VA07890)	
J300	--	JUMPER CABLE	0.55	ジャンパー線	(VA07890)	
-303	--	JUMPER CABLE	0.55	ジャンパー線	(VA07890)	
JK5	VJ88550R	DIN JACK	3P YKF51-5054V	D I N コネクタ	IN-MIDI A-OUT	04
JK10	VS11540R	PHONE JACK BLACK	LGR4609-7100F	ホーンコネクタ(黒)	PEDAL [1 (SUSTAIN)]	01
JK20	VS11540R	PHONE JACK BLACK	LGR4609-7100F	ホーンコネクタ(黒)	PEDAL [2 (ARTICULATION 1)]	01
JK30	VS11540R	PHONE JACK BLACK	LGR4609-7100F	ホーンコネクタ(黒)	PEDAL [3 (VOLUME)]	01
JK40	VJ88550R	DIN JACK	3P YKF51-5054V	D I N コネクタ	IN-MIDI B-OUT	04
JK82	VI311100	PIN JACK	1P YKC21-3017V	ピンジャック 1 P	VIDEO OUT	
JK101	LB101870	HEADPHONE JACK	YKB21-5006	ホーンコネクタ	PHONES	03
JK101	WJ306200	PHONE JACK	MSJ-064-15A B AG	ホーンコネクタ		
JK301	VB312600	PHONE JACK BLACK	YKB21-5012	ホーンコネクタ(黒)	TO LEFT SPEAKER	02
JK302	VB312600	PHONE JACK BLACK	YKB21-5012	ホーンコネクタ(黒)	TO RIGHT SPEAKER	02
L11	VB835000	COIL	FL05RD200AT TE 20uH	コイル 2 0 U		01
L12	VF45660R	COIL	SBT-0180W RX 80uH	コイル 8 0 U		03
L13	VY65720R	CHIP INDUCTANCE	600 BK1608HM601-T	チップインダクタ		01
-20	VY65720R	CHIP INDUCTANCE	600 BK1608HM601-T	チップインダクタ		01
L21	VB835000	COIL	FL05RD200AT TE 20uH	コイル 2 0 U		01
L22	VF45660R	COIL	SBT-0180W RX	コイル 8 0 U		03
L23	VY65720R	CHIP INDUCTANCE	600 BK1608HM601-T	チップインダクタ		01
-25	VY65720R	CHIP INDUCTANCE	600 BK1608HM601-T	チップインダクタ		01
L26	GE300670	FERRIT BEAD	BL02RN2R1P1A TATET	フェライトビーズ		02
L31	VB835000	COIL	FL05RD200AT TE 20uH	コイル 2 0 U		01
L32	VF45660R	COIL	SBT-0180W RX 80uH	コイル 8 0 U		03
L40	VB835000	COIL	FL05RD200AT TE 20uH	コイル 2 0 U		01
L41	VF45660R	COIL	SBT-0180W RX 80uH	コイル 8 0 U		03
L42	VF45660R	COIL	SBT-0180W RX 80uH	コイル 8 0 U		03
L50	VB835000	COIL	FL05RD200AT TE 20uH	コイル 2 0 U		01
L51	VF45660R	COIL	SBT-0180W RX 80uH	コイル 8 0 U		03
L52	VF45660R	COIL	SBT-0180W RX 80uH	コイル 8 0 U		03
L83	VF45660R	COIL	SBT-0180W RX 80uH	コイル 8 0 U		03
L101	GE300670	FERRIT BEAD	BL02RN2R1P1A TATET	フェライトビーズ		02
-105	GE300670	FERRIT BEAD	BL02RN2R1P1A TATET	フェライトビーズ		02
R11	HF75510R	CARBON RESISTOR	100.0 1/4 J AX TP	カーボン抵抗		01
R12	HF75510R	CARBON RESISTOR	100.0 1/4 J AX TP	カーボン抵抗		01
R13	HF75610R	CARBON RESISTOR	1.0K 1/4 J AX TP	カーボン抵抗		01
R14	HF75710R	CARBON RESISTOR	10.0K 1/4 J AX TP	カーボン抵抗		01
R21	HF75510R	CARBON RESISTOR	100.0 1/4 J AX TP	カーボン抵抗		01
R22	HF75510R	CARBON RESISTOR	100.0 1/4 J AX TP	カーボン抵抗		01
R23	HF75610R	CARBON RESISTOR	1.0K 1/4 J AX TP	カーボン抵抗		01
R24	HF75710R	CARBON RESISTOR	10.0K 1/4 J AX TP	カーボン抵抗		01
R31	HF75510R	CARBON RESISTOR	100.0 1/4 J AX TP	カーボン抵抗		01
R32	HF75510R	CARBON RESISTOR	100.0 1/4 J AX TP	カーボン抵抗		01
R33	HF75610R	CARBON RESISTOR	1.0K 1/4 J AX TP	カーボン抵抗		01
R34	HF75710R	CARBON RESISTOR	10.0K 1/4 J AX TP	カーボン抵抗		01
R41	HF75522R	CARBON RESISTOR	220.0 1/4 J AX TP	カーボン抵抗		01
-43	HF75522R	CARBON RESISTOR	220.0 1/4 J AX TP	カーボン抵抗		01
R44	HF75615R	CARBON RESISTOR	1.5K 1/4 J AX TP	カーボン抵抗		01
R45	HF75722R	CARBON RESISTOR	22.0K 1/4 J AX TP	カーボン抵抗		01
R46	HF75722R	CARBON RESISTOR	22.0K 1/4 J AX TP	カーボン抵抗		01
R47	HF75610R	CARBON RESISTOR	1.0K 1/4 J AX TP	カーボン抵抗		01
R51	HF75522R	CARBON RESISTOR	220.0 1/4 J AX TP	カーボン抵抗		01
-53	HF75522R	CARBON RESISTOR	220.0 1/4 J AX TP	カーボン抵抗		01
R54	HF75615R	CARBON RESISTOR	1.5K 1/4 J AX TP	カーボン抵抗		01

*: New Parts

RANK: Japan only

CK/DJK/HP/SPOL/SPOR and DM

REF NO.	PART NO.	DESCRIPTION		部 品 名	REMARKS	QTY	RANK
R55	HF75722R	CARBON RESISTOR	22.0K 1/4 J AX TP	カ ー ボ ン 抵 抗			01
R56	HF75722R	CARBON RESISTOR	22.0K 1/4 J AX TP	カ ー ボ ン 抵 抗			01
R57	HF75610R	CARBON RESISTOR	1.0K 1/4 J AX TP	カ ー ボ ン 抵 抗			01
R101	HV754330	FLAME PROOF C. RESISTOR	33.0 1/4 J RX TP	不 燃 化 カ ー ボ ン 抵 抗			
R102	HV754330	FLAME PROOF C. RESISTOR	33.0 1/4 J RX TP	不 燃 化 カ ー ボ ン 抵 抗			
TR41	IC174020	TRANSISTOR	2SC1740S R,S TP	ト ラ ン ジ ス タ 2 S C	}		
TR41	WC292100	TRANSISTOR	KTC3199-Y-AT/P	ト ラ ン ジ ス タ			
TR42	IC174020	TRANSISTOR	2SC1740S R,S TP	ト ラ ン ジ ス タ 2 S C			
TR42	WC292100	TRANSISTOR	KTC3199-Y-AT/P	ト ラ ン ジ ス タ			
TR51	IC174020	TRANSISTOR	2SC1740S R,S TP	ト ラ ン ジ ス タ 2 S C			
TR51	WC292100	TRANSISTOR	KTC3199-Y-AT/P	ト ラ ン ジ ス タ	}		
TR52	IC174020	TRANSISTOR	2SC1740S R,S TP	ト ラ ン ジ ス タ 2 S C			
TR52	WC292100	TRANSISTOR	KTC3199-Y-AT/P	ト ラ ン ジ ス タ			
*	WM154500	CIRCUIT BOARD	DM	D M シ ー ト	(X9371C0)		
	--	MAC ADDRESS LABEL		M A C ア ド レ ス ラ ベ ル	(WH26440)		
	--	USB EARTH ANGLE		U S B ア ー ス 金 具	(WN33200)		
C1	UF03810R	ELECTROLYTIC CAP. (CHIP)	100 16V	チ ッ プ ケ ミ コ ン			01
C2	US635100	CERAMIC CAPACITOR-F (CHIP)	0.100 16V Z RECT.	チ ッ プ セ ラ (F)			
C3	US635100	CERAMIC CAPACITOR-F (CHIP)	0.100 16V Z RECT.	チ ッ プ セ ラ (F)			
C4	US661100	CERAMIC CAPACITOR-CH(CHIP)	10P 50V D RECT.	チ ッ プ セ ラ (C H)			
-6	US661100	CERAMIC CAPACITOR-CH(CHIP)	10P 50V D RECT.	チ ッ プ セ ラ (C H)			
C7	US663100	CERAMIC CAPACITOR-B (CHIP)	1000P 50V K RECT.	チ ッ プ セ ラ (B)			
C8	US663100	CERAMIC CAPACITOR-B (CHIP)	1000P 50V K RECT.	チ ッ プ セ ラ (B)			
C9	US661100	CERAMIC CAPACITOR-CH(CHIP)	10P 50V D RECT.	チ ッ プ セ ラ (C H)			
C10	US663100	CERAMIC CAPACITOR-B (CHIP)	1000P 50V K RECT.	チ ッ プ セ ラ (B)			
-15	US663100	CERAMIC CAPACITOR-B (CHIP)	1000P 50V K RECT.	チ ッ プ セ ラ (B)			
C16	US635100	CERAMIC CAPACITOR-F (CHIP)	0.100 16V Z RECT.	チ ッ プ セ ラ (F)			
C17	US663100	CERAMIC CAPACITOR-B (CHIP)	1000P 50V K RECT.	チ ッ プ セ ラ (B)			
C18	US663100	CERAMIC CAPACITOR-B (CHIP)	1000P 50V K RECT.	チ ッ プ セ ラ (B)			
C19	V945210R	ELECTROLYTIC CAP. (CHIP)	100.00 6.3V REFLOW	チ ッ プ O S ケ ミ コ ン			03
C20	US663100	CERAMIC CAPACITOR-B (CHIP)	1000P 50V K RECT.	チ ッ プ セ ラ (B)			
C21	US643470	CERAMIC CAPACITOR-B (CHIP)	4700P 25V K RECT.	チ ッ プ セ ラ (B)			01
C24	US635100	CERAMIC CAPACITOR-F (CHIP)	0.100 16V Z RECT.	チ ッ プ セ ラ (F)			
-27	US635100	CERAMIC CAPACITOR-F (CHIP)	0.100 16V Z RECT.	チ ッ プ セ ラ (F)			
C28	US634100	CERAMIC CAPACITOR-B (CHIP)	0.010 16V K RECT.	チ ッ プ セ ラ (B)			01
C29	US635100	CERAMIC CAPACITOR-F (CHIP)	0.100 16V Z RECT.	チ ッ プ セ ラ (F)			
C30	US635100	CERAMIC CAPACITOR-F (CHIP)	0.100 16V Z RECT.	チ ッ プ セ ラ (F)			
C31	US634100	CERAMIC CAPACITOR-B (CHIP)	0.010 16V K RECT.	チ ッ プ セ ラ (B)			01
C32	US635100	CERAMIC CAPACITOR-F (CHIP)	0.100 16V Z RECT.	チ ッ プ セ ラ (F)			
-35	US635100	CERAMIC CAPACITOR-F (CHIP)	0.100 16V Z RECT.	チ ッ プ セ ラ (F)			
C36	UF037100	ELECTROLYTIC CAP. (CHIP)	10 16V	チ ッ プ ケ ミ コ ン			
C38	US635100	CERAMIC CAPACITOR-F (CHIP)	0.100 16V Z RECT.	チ ッ プ セ ラ (F)			
C39	UF03810R	ELECTROLYTIC CAP. (CHIP)	100 16V	チ ッ プ ケ ミ コ ン			01
C40	US634100	CERAMIC CAPACITOR-B (CHIP)	0.010 16V K RECT.	チ ッ プ セ ラ (B)			01
C41	US634100	CERAMIC CAPACITOR-B (CHIP)	0.010 16V K RECT.	チ ッ プ セ ラ (B)			01
C42	UF037100	ELECTROLYTIC CAP. (CHIP)	10 16V	チ ッ プ ケ ミ コ ン			
C43	US635100	CERAMIC CAPACITOR-F (CHIP)	0.100 16V Z RECT.	チ ッ プ セ ラ (F)			
-45	US635100	CERAMIC CAPACITOR-F (CHIP)	0.100 16V Z RECT.	チ ッ プ セ ラ (F)			
C47	US634100	CERAMIC CAPACITOR-B (CHIP)	0.010 16V K RECT.	チ ッ プ セ ラ (B)			01
C48	US635100	CERAMIC CAPACITOR-F (CHIP)	0.100 16V Z RECT.	チ ッ プ セ ラ (F)			
-52	US635100	CERAMIC CAPACITOR-F (CHIP)	0.100 16V Z RECT.	チ ッ プ セ ラ (F)			
C53	US634100	CERAMIC CAPACITOR-B (CHIP)	0.010 16V K RECT.	チ ッ プ セ ラ (B)			01
C54	US635100	CERAMIC CAPACITOR-F (CHIP)	0.100 16V Z RECT.	チ ッ プ セ ラ (F)			
C55	UF01722R	ELECTROLYTIC CAP. (CHIP)	22 6.3V	チ ッ プ ケ ミ コ ン			01
C56	US635100	CERAMIC CAPACITOR-F (CHIP)	0.100 16V Z RECT.	チ ッ プ セ ラ (F)			
C57	US634100	CERAMIC CAPACITOR-B (CHIP)	0.010 16V K RECT.	チ ッ プ セ ラ (B)			01
C58	US634100	CERAMIC CAPACITOR-B (CHIP)	0.010 16V K RECT.	チ ッ プ セ ラ (B)			01
C59	US635100	CERAMIC CAPACITOR-F (CHIP)	0.100 16V Z RECT.	チ ッ プ セ ラ (F)			
C60	US635100	CERAMIC CAPACITOR-F (CHIP)	0.100 16V Z RECT.	チ ッ プ セ ラ (F)			
C61	UF01722R	ELECTROLYTIC CAP. (CHIP)	22 6.3V	チ ッ プ ケ ミ コ ン			01
C62	US635100	CERAMIC CAPACITOR-F (CHIP)	0.100 16V Z RECT.	チ ッ プ セ ラ (F)			
C63	US635100	CERAMIC CAPACITOR-F (CHIP)	0.100 16V Z RECT.	チ ッ プ セ ラ (F)			
C64	US634100	CERAMIC CAPACITOR-B (CHIP)	0.010 16V K RECT.	チ ッ プ セ ラ (B)			01
C65	US634100	CERAMIC CAPACITOR-B (CHIP)	0.010 16V K RECT.	チ ッ プ セ ラ (B)			01
C66	US635100	CERAMIC CAPACITOR-F (CHIP)	0.100 16V Z RECT.	チ ッ プ セ ラ (F)			
C67	UF01722R	ELECTROLYTIC CAP. (CHIP)	22 6.3V	チ ッ プ ケ ミ コ ン			01
C68	US635100	CERAMIC CAPACITOR-F (CHIP)	0.100 16V Z RECT.	チ ッ プ セ ラ (F)			
C69	US634100	CERAMIC CAPACITOR-B (CHIP)	0.010 16V K RECT.	チ ッ プ セ ラ (B)			
C70	US635100	CERAMIC CAPACITOR-F (CHIP)	0.100 16V Z RECT.	チ ッ プ セ ラ (F)			01

*: New Parts

RANK: Japan only

DM

REF NO.	PART NO.	DESCRIPTION	部 品 名	REMARKS	QTY	RANK
C71	US634100	CERAMIC CAPACITOR-B (CHIP)	0.010 16V K RECT.	チップセラ (B)		01
C72	US634100	CERAMIC CAPACITOR-B (CHIP)	0.010 16V K RECT.	チップセラ (B)		01
C73	US635100	CERAMIC CAPACITOR-F (CHIP)	0.100 16V Z RECT.	チップセラ (F)		
C74	UF01722R	ELECTROLYTIC CAP. (CHIP)	22 6.3V	チップケミコン		01
C75	UF01722R	ELECTROLYTIC CAP. (CHIP)	22 6.3V	チップケミコン		01
C76	US662470	CERAMIC CAPACITOR-B (CHIP)	470P 50V K RECT.	チップセラ (B)		01
C77	US662470	CERAMIC CAPACITOR-B (CHIP)	470P 50V K RECT.	チップセラ (B)		01
C78	US635100	CERAMIC CAPACITOR-F (CHIP)	0.100 16V Z RECT.	チップセラ (F)		
C79	US634100	CERAMIC CAPACITOR-B (CHIP)	0.010 16V K RECT.	チップセラ (B)		01
C80	US634100	CERAMIC CAPACITOR-B (CHIP)	0.010 16V K RECT.	チップセラ (B)		01
C81	US635100	CERAMIC CAPACITOR-F (CHIP)	0.100 16V Z RECT.	チップセラ (F)		
C82	US635100	CERAMIC CAPACITOR-F (CHIP)	0.100 16V Z RECT.	チップセラ (F)		
C83	US634100	CERAMIC CAPACITOR-B (CHIP)	0.010 16V K RECT.	チップセラ (B)		01
-85	US634100	CERAMIC CAPACITOR-B (CHIP)	0.010 16V K RECT.	チップセラ (B)		01
C86	V945210R	ELECTROLYTIC CAP. (CHIP)	100.00 6.3V REFLOW	チップ O S ケミコン		03
C89	US635100	CERAMIC CAPACITOR-F (CHIP)	0.100 16V Z RECT.	チップセラ (F)		
C90	US635100	CERAMIC CAPACITOR-F (CHIP)	0.100 16V Z RECT.	チップセラ (F)		
C91	US634100	CERAMIC CAPACITOR-B (CHIP)	0.010 16V K RECT.	チップセラ (B)		01
C92	UF037100	ELECTROLYTIC CAP. (CHIP)	10 16V	チップケミコン		
C93	US634100	CERAMIC CAPACITOR-B (CHIP)	0.010 16V K RECT.	チップセラ (B)		01
C94	US662470	CERAMIC CAPACITOR-B (CHIP)	470P 50V K RECT.	チップセラ (B)		01
C95	US662470	CERAMIC CAPACITOR-B (CHIP)	470P 50V K RECT.	チップセラ (B)		01
C96	US634100	CERAMIC CAPACITOR-B (CHIP)	0.010 16V K RECT.	チップセラ (B)		01
C97	US662470	CERAMIC CAPACITOR-B (CHIP)	470P 50V K RECT.	チップセラ (B)		01
C98	US634100	CERAMIC CAPACITOR-B (CHIP)	0.010 16V K RECT.	チップセラ (B)		01
C99	US662470	CERAMIC CAPACITOR-B (CHIP)	470P 50V K RECT.	チップセラ (B)		01
C100	US634100	CERAMIC CAPACITOR-B (CHIP)	0.010 16V K RECT.	チップセラ (B)		01
C101	UF037100	ELECTROLYTIC CAP. (CHIP)	10 16V	チップケミコン		
C102	US634100	CERAMIC CAPACITOR-B (CHIP)	0.010 16V K RECT.	チップセラ (B)		01
C103	US662470	CERAMIC CAPACITOR-B (CHIP)	470P 50V K RECT.	チップセラ (B)		01
C104	US662470	CERAMIC CAPACITOR-B (CHIP)	470P 50V K RECT.	チップセラ (B)		01
C105	US634100	CERAMIC CAPACITOR-B (CHIP)	0.010 16V K RECT.	チップセラ (B)		01
C106	US662470	CERAMIC CAPACITOR-B (CHIP)	470P 50V K RECT.	チップセラ (B)		01
C107	US634100	CERAMIC CAPACITOR-B (CHIP)	0.010 16V K RECT.	チップセラ (B)		01
C108	US662470	CERAMIC CAPACITOR-B (CHIP)	470P 50V K RECT.	チップセラ (B)		01
C109	US634100	CERAMIC CAPACITOR-B (CHIP)	0.010 16V K RECT.	チップセラ (B)		01
C110	UF037100	ELECTROLYTIC CAP. (CHIP)	10 16V	チップケミコン		
C111	US662470	CERAMIC CAPACITOR-B (CHIP)	470P 50V K RECT.	チップセラ (B)		01
C112	US634100	CERAMIC CAPACITOR-B (CHIP)	0.010 16V K RECT.	チップセラ (B)		01
C113	US662470	CERAMIC CAPACITOR-B (CHIP)	470P 50V K RECT.	チップセラ (B)		01
C114	US634100	CERAMIC CAPACITOR-B (CHIP)	0.010 16V K RECT.	チップセラ (B)		01
C115	US662470	CERAMIC CAPACITOR-B (CHIP)	470P 50V K RECT.	チップセラ (B)		01
C116	US634100	CERAMIC CAPACITOR-B (CHIP)	0.010 16V K RECT.	チップセラ (B)		01
C117	US662470	CERAMIC CAPACITOR-B (CHIP)	470P 50V K RECT.	チップセラ (B)		01
C118	US634100	CERAMIC CAPACITOR-B (CHIP)	0.010 16V K RECT.	チップセラ (B)		01
-120	US634100	CERAMIC CAPACITOR-B (CHIP)	0.010 16V K RECT.	チップセラ (B)		01
C121	US635100	CERAMIC CAPACITOR-F (CHIP)	0.100 16V Z RECT.	チップセラ (F)		
-124	US635100	CERAMIC CAPACITOR-F (CHIP)	0.100 16V Z RECT.	チップセラ (F)		
C125	US634100	CERAMIC CAPACITOR-B (CHIP)	0.010 16V K RECT.	チップセラ (B)		01
-127	US634100	CERAMIC CAPACITOR-B (CHIP)	0.010 16V K RECT.	チップセラ (B)		01
C128	US635100	CERAMIC CAPACITOR-F (CHIP)	0.100 16V Z RECT.	チップセラ (F)		
C129	US635100	CERAMIC CAPACITOR-F (CHIP)	0.100 16V Z RECT.	チップセラ (F)		
C130	UF037100	ELECTROLYTIC CAP. (CHIP)	10 16V	チップケミコン		
C131	US634100	CERAMIC CAPACITOR-B (CHIP)	0.010 16V K RECT.	チップセラ (B)		01
-135	US634100	CERAMIC CAPACITOR-B (CHIP)	0.010 16V K RECT.	チップセラ (B)		01
C137	US634100	CERAMIC CAPACITOR-B (CHIP)	0.010 16V K RECT.	チップセラ (B)		01
C139	US635100	CERAMIC CAPACITOR-F (CHIP)	0.100 16V Z RECT.	チップセラ (F)		
-152	US635100	CERAMIC CAPACITOR-F (CHIP)	0.100 16V Z RECT.	チップセラ (F)		
C200	UF12847R	ELECTROLYTIC CAP. (CHIP)	470 10V	チップケミコン		02
C201	UF12847R	ELECTROLYTIC CAP. (CHIP)	470 10V	チップケミコン		02
C202	US634100	CERAMIC CAPACITOR-B (CHIP)	0.010 16V K RECT.	チップセラ (B)		01
C203	US634100	CERAMIC CAPACITOR-B (CHIP)	0.010 16V K RECT.	チップセラ (B)		01
C204	UF12847R	ELECTROLYTIC CAP. (CHIP)	470 10V	チップケミコン		02
C205	US634100	CERAMIC CAPACITOR-B (CHIP)	0.010 16V K RECT.	チップセラ (B)		01
-208	US634100	CERAMIC CAPACITOR-B (CHIP)	0.010 16V K RECT.	チップセラ (B)		01
C210	US661220	CERAMIC CAPACITOR-CH(CHIP)	22P 50V J RECT.	チップセラ (C H)		
C213	US661220	CERAMIC CAPACITOR-CH(CHIP)	22P 50V J RECT.	チップセラ (C H)		
C215	US635100	CERAMIC CAPACITOR-F (CHIP)	0.100 16V Z RECT.	チップセラ (F)		
C216	US635100	CERAMIC CAPACITOR-F (CHIP)	0.100 16V Z RECT.	チップセラ (F)		
C217	US634100	CERAMIC CAPACITOR-B (CHIP)	0.010 16V K RECT.	チップセラ (B)		01

*: New Parts

RANK: Japan only

DM

REF NO.	PART NO.	DESCRIPTION	部 品 名	REMARKS	QTY	RANK
C218	US635100	CERAMIC CAPACITOR-F (CHIP)	0.100 16V Z RECT.	チ ッ プ セ ラ (F)		
C219	US634100	CERAMIC CAPACITOR-B (CHIP)	0.010 16V K RECT.	チ ッ プ セ ラ (B)		01
-223	US634100	CERAMIC CAPACITOR-B (CHIP)	0.010 16V K RECT.	チ ッ プ セ ラ (B)		01
C224	UF03810R	ELECTROLYTIC CAP. (CHIP)	100 16V	チ ッ プ ケ ミ コ ン		01
C225	UF03810R	ELECTROLYTIC CAP. (CHIP)	100 16V	チ ッ プ ケ ミ コ ン		01
C226	US635100	CERAMIC CAPACITOR-F (CHIP)	0.100 16V Z RECT.	チ ッ プ セ ラ (F)		
C227	UF037100	ELECTROLYTIC CAP. (CHIP)	10 16V	チ ッ プ ケ ミ コ ン		
C228	UF056470	ELECTROLYTIC CAP. (CHIP)	4.7 35V	チ ッ プ ケ ミ コ ン		01
C229	UF037100	ELECTROLYTIC CAP. (CHIP)	10 16V	チ ッ プ ケ ミ コ ン		
C230	US635100	CERAMIC CAPACITOR-F (CHIP)	0.100 16V Z RECT.	チ ッ プ セ ラ (F)		
C231	US634100	CERAMIC CAPACITOR-B (CHIP)	0.010 16V K RECT.	チ ッ プ セ ラ (B)		01
C232	US635100	CERAMIC CAPACITOR-F (CHIP)	0.100 16V Z RECT.	チ ッ プ セ ラ (F)		
C233	US126100	CERAMIC CAPACITOR-F (CHIP)	1.0000 10V Z RECT.	チ ッ プ セ ラ F		01
C234	US634100	CERAMIC CAPACITOR-B (CHIP)	0.010 16V K RECT.	チ ッ プ セ ラ (B)		01
C235	US635100	CERAMIC CAPACITOR-F (CHIP)	0.100 16V Z RECT.	チ ッ プ セ ラ (F)		
C236	US634100	CERAMIC CAPACITOR-B (CHIP)	0.010 16V K RECT.	チ ッ プ セ ラ (B)		01
C237	US635100	CERAMIC CAPACITOR-F (CHIP)	0.100 16V Z RECT.	チ ッ プ セ ラ (F)		
-242	US635100	CERAMIC CAPACITOR-F (CHIP)	0.100 16V Z RECT.	チ ッ プ セ ラ (F)		
C244	US661100	CERAMIC CAPACITOR-CH(CHIP)	10P 50V D RECT.	チ ッ プ セ ラ (C H)		
C246	US661120	CERAMIC CAPACITOR-CH(CHIP)	12P 50V J RECT.	チ ッ プ セ ラ (C H)		
C247	US661120	CERAMIC CAPACITOR-CH(CHIP)	12P 50V J RECT.	チ ッ プ セ ラ (C H)		
C248	US661100	CERAMIC CAPACITOR-CH(CHIP)	10P 50V D RECT.	チ ッ プ セ ラ (C H)		
C249	US634100	CERAMIC CAPACITOR-B (CHIP)	0.010 16V K RECT.	チ ッ プ セ ラ (B)		01
C250	US635100	CERAMIC CAPACITOR-F (CHIP)	0.100 16V Z RECT.	チ ッ プ セ ラ (F)		
-252	US635100	CERAMIC CAPACITOR-F (CHIP)	0.100 16V Z RECT.	チ ッ プ セ ラ (F)		
C253	V945030R	ELECTROLYTIC CAP. (CHIP)	10.00 10.0V REFLOW	チ ッ プ O S ケ ミ コ ン		02
C254	US635100	CERAMIC CAPACITOR-F (CHIP)	0.100 16V Z RECT.	チ ッ プ セ ラ (F)		
-256	US635100	CERAMIC CAPACITOR-F (CHIP)	0.100 16V Z RECT.	チ ッ プ セ ラ (F)		
C257	US634100	CERAMIC CAPACITOR-B (CHIP)	0.010 16V K RECT.	チ ッ プ セ ラ (B)		01
-262	US634100	CERAMIC CAPACITOR-B (CHIP)	0.010 16V K RECT.	チ ッ プ セ ラ (B)		01
C263	US635100	CERAMIC CAPACITOR-F (CHIP)	0.100 16V Z RECT.	チ ッ プ セ ラ (F)		
-266	US635100	CERAMIC CAPACITOR-F (CHIP)	0.100 16V Z RECT.	チ ッ プ セ ラ (F)		
C267	US662470	CERAMIC CAPACITOR-B (CHIP)	470P 50V K RECT.	チ ッ プ セ ラ (B)		01
C268	US662470	CERAMIC CAPACITOR-B (CHIP)	470P 50V K RECT.	チ ッ プ セ ラ (B)		01
C269	US135220	CERAMIC CAPACITOR-F (CHIP)	0.2200 16V Z RECT.	チ ッ プ セ ラ (F)		01
C270	US635100	CERAMIC CAPACITOR-F (CHIP)	0.100 16V Z RECT.	チ ッ プ セ ラ (F)		
C271	US662470	CERAMIC CAPACITOR-B (CHIP)	470P 50V K RECT.	チ ッ プ セ ラ (B)		01
C272	US635100	CERAMIC CAPACITOR-F (CHIP)	0.100 16V Z RECT.	チ ッ プ セ ラ (F)		
C273	US635100	CERAMIC CAPACITOR-F (CHIP)	0.100 16V Z RECT.	チ ッ プ セ ラ (F)		
C274	US634100	CERAMIC CAPACITOR-B (CHIP)	0.010 16V K RECT.	チ ッ プ セ ラ (B)		01
-277	US634100	CERAMIC CAPACITOR-B (CHIP)	0.010 16V K RECT.	チ ッ プ セ ラ (B)		01
C278	US635100	CERAMIC CAPACITOR-F (CHIP)	0.100 16V Z RECT.	チ ッ プ セ ラ (F)		
C279	US662470	CERAMIC CAPACITOR-B (CHIP)	470P 50V K RECT.	チ ッ プ セ ラ (B)		01
C280	US634100	CERAMIC CAPACITOR-B (CHIP)	0.010 16V K RECT.	チ ッ プ セ ラ (B)		01
C281	US634100	CERAMIC CAPACITOR-B (CHIP)	0.010 16V K RECT.	チ ッ プ セ ラ (B)		01
C282	UF037100	ELECTROLYTIC CAP. (CHIP)	10 16V	チ ッ プ ケ ミ コ ン		
C283	US635100	CERAMIC CAPACITOR-F (CHIP)	0.100 16V Z RECT.	チ ッ プ セ ラ (F)		
C284	US662470	CERAMIC CAPACITOR-B (CHIP)	470P 50V K RECT.	チ ッ プ セ ラ (B)		01
C285	US635100	CERAMIC CAPACITOR-F (CHIP)	0.100 16V Z RECT.	チ ッ プ セ ラ (F)		
C286	US634100	CERAMIC CAPACITOR-B (CHIP)	0.010 16V K RECT.	チ ッ プ セ ラ (B)		01
C287	US634100	CERAMIC CAPACITOR-B (CHIP)	0.010 16V K RECT.	チ ッ プ セ ラ (B)		01
C288	US662470	CERAMIC CAPACITOR-B (CHIP)	470P 50V K RECT.	チ ッ プ セ ラ (B)		01
C289	UF037100	ELECTROLYTIC CAP. (CHIP)	10 16V	チ ッ プ ケ ミ コ ン		
C290	US635100	CERAMIC CAPACITOR-F (CHIP)	0.100 16V Z RECT.	チ ッ プ セ ラ (F)		
C291	US662470	CERAMIC CAPACITOR-B (CHIP)	470P 50V K RECT.	チ ッ プ セ ラ (B)		01
C292	US635100	CERAMIC CAPACITOR-F (CHIP)	0.100 16V Z RECT.	チ ッ プ セ ラ (F)		
C293	US662470	CERAMIC CAPACITOR-B (CHIP)	470P 50V K RECT.	チ ッ プ セ ラ (B)		01
C294	US635100	CERAMIC CAPACITOR-F (CHIP)	0.100 16V Z RECT.	チ ッ プ セ ラ (F)		
C295	US662470	CERAMIC CAPACITOR-B (CHIP)	470P 50V K RECT.	チ ッ プ セ ラ (B)		01
C296	US635100	CERAMIC CAPACITOR-F (CHIP)	0.100 16V Z RECT.	チ ッ プ セ ラ (F)		
C297	US662470	CERAMIC CAPACITOR-B (CHIP)	470P 50V K RECT.	チ ッ プ セ ラ (B)		01
C298	V945030R	ELECTROLYTIC CAP. (CHIP)	10.00 10.0V REFLOW	チ ッ プ O S ケ ミ コ ン		02
C299	US635100	CERAMIC CAPACITOR-F (CHIP)	0.100 16V Z RECT.	チ ッ プ セ ラ (F)		
C300	US634100	CERAMIC CAPACITOR-B (CHIP)	0.010 16V K RECT.	チ ッ プ セ ラ (B)		01
C301	UF037100	ELECTROLYTIC CAP. (CHIP)	10 16V	チ ッ プ ケ ミ コ ン		
C302	US634100	CERAMIC CAPACITOR-B (CHIP)	0.010 16V K RECT.	チ ッ プ セ ラ (B)		01
-306	US634100	CERAMIC CAPACITOR-B (CHIP)	0.010 16V K RECT.	チ ッ プ セ ラ (B)		01
C307	US635100	CERAMIC CAPACITOR-F (CHIP)	0.100 16V Z RECT.	チ ッ プ セ ラ (F)		
C308	US634100	CERAMIC CAPACITOR-B (CHIP)	0.010 16V K RECT.	チ ッ プ セ ラ (B)		01
C309	US634100	CERAMIC CAPACITOR-B (CHIP)	0.010 16V K RECT.	チ ッ プ セ ラ (B)		01

*: New Parts

RANK: Japan only

DM

REF NO.	PART NO.	DESCRIPTION	部 品 名	REMARKS	QTY	RANK
C310	US635100	CERAMIC CAPACITOR-F (CHIP)	0.100 16V Z RECT.	チップセラ(F)		
C311	US635100	CERAMIC CAPACITOR-F (CHIP)	0.100 16V Z RECT.	チップセラ(F)		
C312	US634100	CERAMIC CAPACITOR-B (CHIP)	0.010 16V K RECT.	チップセラ(B)		01
C313	US663100	CERAMIC CAPACITOR-B (CHIP)	1000P 50V K RECT.	チップセラ(B)		
C314	US635100	CERAMIC CAPACITOR-F (CHIP)	0.100 16V Z RECT.	チップセラ(F)		
C315	UF037100	ELECTROLYTIC CAP. (CHIP)	10 16V	チップケミコン		
C316	US634100	CERAMIC CAPACITOR-B (CHIP)	0.010 16V K RECT.	チップセラ(B)		01
-320	US634100	CERAMIC CAPACITOR-B (CHIP)	0.010 16V K RECT.	チップセラ(B)		01
C321	US661120	CERAMIC CAPACITOR-CH(CHIP)	12P 50V J RECT.	チップセラ(CH)		
C322	US663100	CERAMIC CAPACITOR-B (CHIP)	1000P 50V K RECT.	チップセラ(B)		
C325	US634100	CERAMIC CAPACITOR-B (CHIP)	0.010 16V K RECT.	チップセラ(B)		01
C328	US661120	CERAMIC CAPACITOR-CH(CHIP)	12P 50V J RECT.	チップセラ(CH)		
C335	US634100	CERAMIC CAPACITOR-B (CHIP)	0.010 16V K RECT.	チップセラ(B)		01
C344	UF037100	ELECTROLYTIC CAP. (CHIP)	10 16V	チップケミコン		
C345	US634100	CERAMIC CAPACITOR-B (CHIP)	0.010 16V K RECT.	チップセラ(B)		01
C346	US634100	CERAMIC CAPACITOR-B (CHIP)	0.010 16V K RECT.	チップセラ(B)		01
C351	US662100	CERAMIC CAPACITOR-CH (CHIP)	100P 50V J RECT.	チップセラ(CH)		
C352	US662100	CERAMIC CAPACITOR-CH (CHIP)	100P 50V J RECT.	チップセラ(CH)		
C356	US661220	CERAMIC CAPACITOR-CH (CHIP)	22P 50V J RECT.	チップセラ(CH)		
C359	US661220	CERAMIC CAPACITOR-CH (CHIP)	22P 50V J RECT.	チップセラ(CH)		
C361	US634100	CERAMIC CAPACITOR-B (CHIP)	0.010 16V K RECT.	チップセラ(B)		01
C362	US634100	CERAMIC CAPACITOR-B (CHIP)	0.010 16V K RECT.	チップセラ(B)		01
C363	US635100	CERAMIC CAPACITOR-F (CHIP)	0.100 16V Z RECT.	チップセラ(F)		
C364	V945030R	ELECTROLYTIC CAP. (CHIP)	10.00 10.0V REFLOW	チップOSケミコン		02
C365	US634100	CERAMIC CAPACITOR-B (CHIP)	0.010 16V K RECT.	チップセラ(B)		01
C366	US634100	CERAMIC CAPACITOR-B (CHIP)	0.010 16V K RECT.	チップセラ(B)		01
C367	US635100	CERAMIC CAPACITOR-F (CHIP)	0.100 16V Z RECT.	チップセラ(F)		
-380	US635100	CERAMIC CAPACITOR-F (CHIP)	0.100 16V Z RECT.	チップセラ(F)		
C382	US635100	CERAMIC CAPACITOR-F (CHIP)	0.100 16V Z RECT.	チップセラ(F)		
-386	US635100	CERAMIC CAPACITOR-F (CHIP)	0.100 16V Z RECT.	チップセラ(F)		
C400	US635100	CERAMIC CAPACITOR-F (CHIP)	0.100 16V Z RECT.	チップセラ(F)		
C401	US635100	CERAMIC CAPACITOR-F (CHIP)	0.100 16V Z RECT.	チップセラ(F)		
C402	US634100	CERAMIC CAPACITOR-B (CHIP)	0.010 16V K RECT.	チップセラ(B)		01
C403	US634100	CERAMIC CAPACITOR-B (CHIP)	0.010 16V K RECT.	チップセラ(B)		01
C404	US635100	CERAMIC CAPACITOR-F (CHIP)	0.100 16V Z RECT.	チップセラ(F)		
C406	US634100	CERAMIC CAPACITOR-B (CHIP)	0.010 16V K RECT.	チップセラ(B)		01
C408	US660700	CERAMIC CAPACITOR-CH (CHIP)	7P 50V D RECT.	チップセラ(CH)		01
C409	US661120	CERAMIC CAPACITOR-CH (CHIP)	12P 50V J RECT.	チップセラ(CH)		
C410	US660700	CERAMIC CAPACITOR-CH (CHIP)	7P 50V D RECT.	チップセラ(CH)		01
C411	US661120	CERAMIC CAPACITOR-CH (CHIP)	12P 50V J RECT.	チップセラ(CH)		
C412	UF037100	ELECTROLYTIC CAP. (CHIP)	10 16V	チップケミコン		
C413	US635100	CERAMIC CAPACITOR-F (CHIP)	0.100 16V Z RECT.	チップセラ(F)		
C416	US662470	CERAMIC CAPACITOR-B (CHIP)	470P 50V K RECT.	チップセラ(B)		01
C419	US662470	CERAMIC CAPACITOR-B (CHIP)	470P 50V K RECT.	チップセラ(B)		01
-421	US662470	CERAMIC CAPACITOR-B (CHIP)	470P 50V K RECT.	チップセラ(B)		01
C422	US634100	CERAMIC CAPACITOR-B (CHIP)	0.010 16V K RECT.	チップセラ(B)		01
-424	US634100	CERAMIC CAPACITOR-B (CHIP)	0.010 16V K RECT.	チップセラ(B)		01
C425	US661680	CERAMIC CAPACITOR-CH (CHIP)	68P 50V J RECT.	チップセラ(CH)		
C426	US663150	CERAMIC CAPACITOR-B (CHIP)	1500P 50V K RECT.	チップセラ(B)		
C427	US662470	CERAMIC CAPACITOR-B (CHIP)	470P 50V K RECT.	チップセラ(B)		01
C428	US634100	CERAMIC CAPACITOR-B (CHIP)	0.010 16V K RECT.	チップセラ(B)		01
C429	UF037100	ELECTROLYTIC CAP. (CHIP)	10 16V	チップケミコン		
C430	US634100	CERAMIC CAPACITOR-B (CHIP)	0.010 16V K RECT.	チップセラ(B)		01
C431	US662470	CERAMIC CAPACITOR-B (CHIP)	470P 50V K RECT.	チップセラ(B)		01
C432	US634100	CERAMIC CAPACITOR-B (CHIP)	0.010 16V K RECT.	チップセラ(B)		01
C433	US634100	CERAMIC CAPACITOR-B (CHIP)	0.010 16V K RECT.	チップセラ(B)		01
C434	US662470	CERAMIC CAPACITOR-B (CHIP)	470P 50V K RECT.	チップセラ(B)		01
C435	US634100	CERAMIC CAPACITOR-B (CHIP)	0.010 16V K RECT.	チップセラ(B)		01
C436	US662470	CERAMIC CAPACITOR-B (CHIP)	470P 50V K RECT.	チップセラ(B)		01
C437	US634100	CERAMIC CAPACITOR-B (CHIP)	0.010 16V K RECT.	チップセラ(B)		01
C438	US634100	CERAMIC CAPACITOR-B (CHIP)	0.010 16V K RECT.	チップセラ(B)		01
C439	US662470	CERAMIC CAPACITOR-B (CHIP)	470P 50V K RECT.	チップセラ(B)		01
C440	UF037100	ELECTROLYTIC CAP. (CHIP)	10 16V	チップケミコン		
C441	US662470	CERAMIC CAPACITOR-B (CHIP)	470P 50V K RECT.	チップセラ(B)		01
C442	US634100	CERAMIC CAPACITOR-B (CHIP)	0.010 16V K RECT.	チップセラ(B)		01
C443	US662470	CERAMIC CAPACITOR-B (CHIP)	470P 50V K RECT.	チップセラ(B)		01
C444	US635100	CERAMIC CAPACITOR-F (CHIP)	0.100 16V Z RECT.	チップセラ(F)		
-446	US635100	CERAMIC CAPACITOR-F (CHIP)	0.100 16V Z RECT.	チップセラ(F)		
C447	US662470	CERAMIC CAPACITOR-B (CHIP)	470P 50V K RECT.	チップセラ(B)		01
C448	US634100	CERAMIC CAPACITOR-B (CHIP)	0.010 16V K RECT.	チップセラ(B)		01

*: New Parts

RANK: Japan only

DM

REF NO.	PART NO.	DESCRIPTION	部 品 名	REMARKS	QTY	RANK
-451	US634100	CERAMIC CAPACITOR-B (CHIP)	0.010 16V K RECT.	チ ッ プ セ ラ (B)		01
C452	US662470	CERAMIC CAPACITOR-B (CHIP)	470P 50V K RECT.	チ ッ プ セ ラ (B)		01
C453	US662470	CERAMIC CAPACITOR-B (CHIP)	470P 50V K RECT.	チ ッ プ セ ラ (B)		01
C454	US635100	CERAMIC CAPACITOR-F (CHIP)	0.100 16V Z RECT.	チ ッ プ セ ラ (F)		
-456	US635100	CERAMIC CAPACITOR-F (CHIP)	0.100 16V Z RECT.	チ ッ プ セ ラ (F)		
C457	US634100	CERAMIC CAPACITOR-B (CHIP)	0.010 16V K RECT.	チ ッ プ セ ラ (B)		01
C458	US634100	CERAMIC CAPACITOR-B (CHIP)	0.010 16V K RECT.	チ ッ プ セ ラ (B)		01
C459	UF037100	ELECTROLYTIC CAP. (CHIP)	10 16V	チ ッ プ ケ ミ コ ン		
C460	US662470	CERAMIC CAPACITOR-B (CHIP)	470P 50V K RECT.	チ ッ プ セ ラ (B)		01
-463	US662470	CERAMIC CAPACITOR-B (CHIP)	470P 50V K RECT.	チ ッ プ セ ラ (B)		01
C464	US634100	CERAMIC CAPACITOR-B (CHIP)	0.010 16V K RECT.	チ ッ プ セ ラ (B)		01
-468	US634100	CERAMIC CAPACITOR-B (CHIP)	0.010 16V K RECT.	チ ッ プ セ ラ (B)		01
C469	US635100	CERAMIC CAPACITOR-F (CHIP)	0.100 16V Z RECT.	チ ッ プ セ ラ (F)		
-472	US635100	CERAMIC CAPACITOR-F (CHIP)	0.100 16V Z RECT.	チ ッ プ セ ラ (F)		
C473	US661470	CERAMIC CAPACITOR-CH (CHIP)	47P 50V J RECT.	チ ッ プ セ ラ (C H)		01
C474	US660500	CERAMIC CAPACITOR-CH (CHIP)	5P 50V C RECT.	チ ッ プ セ ラ (C H)		
C475	US634100	CERAMIC CAPACITOR-B (CHIP)	0.010 16V K RECT.	チ ッ プ セ ラ (B)		01
C476	US634100	CERAMIC CAPACITOR-B (CHIP)	0.010 16V K RECT.	チ ッ プ セ ラ (B)		01
C477	US661150	CERAMIC CAPACITOR-CH (CHIP)	15P 50V J RECT.	チ ッ プ セ ラ (C H)		
C478	US661100	CERAMIC CAPACITOR-CH (CHIP)	10P 50V D RECT.	チ ッ プ セ ラ (C H)		
-480	US661100	CERAMIC CAPACITOR-CH (CHIP)	10P 50V D RECT.	チ ッ プ セ ラ (C H)		
C500	UF037100	ELECTROLYTIC CAP. (CHIP)	10 16V	チ ッ プ ケ ミ コ ン		
C501	UF037100	ELECTROLYTIC CAP. (CHIP)	10 16V	チ ッ プ ケ ミ コ ン		
C502	US635100	CERAMIC CAPACITOR-F (CHIP)	0.100 16V Z RECT.	チ ッ プ セ ラ (F)		
-505	US635100	CERAMIC CAPACITOR-F (CHIP)	0.100 16V Z RECT.	チ ッ プ セ ラ (F)		
C506	V945210R	ELECTROLYTIC CAP. (CHIP)	100.00 6.3V REFLOW	チ ッ プ O S ケ ミ コ ン		03
C507	V945210R	ELECTROLYTIC CAP. (CHIP)	100.00 6.3V REFLOW	チ ッ プ O S ケ ミ コ ン		03
C508	UF037100	ELECTROLYTIC CAP. (CHIP)	10 16V	チ ッ プ ケ ミ コ ン		
C509	US634100	CERAMIC CAPACITOR-B (CHIP)	0.010 16V K RECT.	チ ッ プ セ ラ (B)		01
C510	US635100	CERAMIC CAPACITOR-F (CHIP)	0.100 16V Z RECT.	チ ッ プ セ ラ (F)		
C511	US635100	CERAMIC CAPACITOR-F (CHIP)	0.100 16V Z RECT.	チ ッ プ セ ラ (F)		
C512	US634100	CERAMIC CAPACITOR-B (CHIP)	0.010 16V K RECT.	チ ッ プ セ ラ (B)		01
C513	US635100	CERAMIC CAPACITOR-F (CHIP)	0.100 16V Z RECT.	チ ッ プ セ ラ (F)		
C514	US634100	CERAMIC CAPACITOR-B (CHIP)	0.010 16V K RECT.	チ ッ プ セ ラ (B)		01
C515	UF037100	ELECTROLYTIC CAP. (CHIP)	10 16V	チ ッ プ ケ ミ コ ン		
C516	US635100	CERAMIC CAPACITOR-F (CHIP)	0.100 16V Z RECT.	チ ッ プ セ ラ (F)		
C517	US635100	CERAMIC CAPACITOR-F (CHIP)	0.100 16V Z RECT.	チ ッ プ セ ラ (F)		
C519	US635100	CERAMIC CAPACITOR-F (CHIP)	0.100 16V Z RECT.	チ ッ プ セ ラ (F)		
C520	US635100	CERAMIC CAPACITOR-F (CHIP)	0.100 16V Z RECT.	チ ッ プ セ ラ (F)		
C521	UF037100	ELECTROLYTIC CAP. (CHIP)	10 16V	チ ッ プ ケ ミ コ ン		
C522	US635100	CERAMIC CAPACITOR-F (CHIP)	0.100 16V Z RECT.	チ ッ プ セ ラ (F)		
C523	WG888300	CHIP MULTILAYER CERAMIC	10.0 6.3V K TP	チ ッ プ 積 層 セ ラ コ ン		
C524	US662470	CERAMIC CAPACITOR-B (CHIP)	470P 50V K RECT.	チ ッ プ セ ラ (B)		01
C525	US634100	CERAMIC CAPACITOR-B (CHIP)	0.010 16V K RECT.	チ ッ プ セ ラ (B)		01
C526	US662470	CERAMIC CAPACITOR-B (CHIP)	470P 50V K RECT.	チ ッ プ セ ラ (B)		01
C527	US634100	CERAMIC CAPACITOR-B (CHIP)	0.010 16V K RECT.	チ ッ プ セ ラ (B)		01
C528	WG888300	CHIP MULTILAYER CERAMIC	10.0 6.3V K TP	チ ッ プ 積 層 セ ラ コ ン		
C529	US635100	CERAMIC CAPACITOR-F (CHIP)	0.100 16V Z RECT.	チ ッ プ セ ラ (F)		
C530	V945210R	ELECTROLYTIC CAP. (CHIP)	100.00 6.3V REFLOW	チ ッ プ O S ケ ミ コ ン		03
C533	US661120	CERAMIC CAPACITOR-CH (CHIP)	12P 50V J RECT.	チ ッ プ セ ラ (C H)		
C534	US661120	CERAMIC CAPACITOR-CH (CHIP)	12P 50V J RECT.	チ ッ プ セ ラ (C H)		
C535	US662470	CERAMIC CAPACITOR-B (CHIP)	470P 50V K RECT.	チ ッ プ セ ラ (B)		01
C536	US634100	CERAMIC CAPACITOR-B (CHIP)	0.010 16V K RECT.	チ ッ プ セ ラ (B)		01
C537	US662470	CERAMIC CAPACITOR-B (CHIP)	470P 50V K RECT.	チ ッ プ セ ラ (B)		01
C538	US634100	CERAMIC CAPACITOR-B (CHIP)	0.010 16V K RECT.	チ ッ プ セ ラ (B)		01
C539	US662470	CERAMIC CAPACITOR-B (CHIP)	470P 50V K RECT.	チ ッ プ セ ラ (B)		01
C540	US634100	CERAMIC CAPACITOR-B (CHIP)	0.010 16V K RECT.	チ ッ プ セ ラ (B)		01
C541	US662470	CERAMIC CAPACITOR-B (CHIP)	470P 50V K RECT.	チ ッ プ セ ラ (B)		01
C542	US634100	CERAMIC CAPACITOR-B (CHIP)	0.010 16V K RECT.	チ ッ プ セ ラ (B)		01
C543	US662470	CERAMIC CAPACITOR-B (CHIP)	470P 50V K RECT.	チ ッ プ セ ラ (B)		01
C544	US634100	CERAMIC CAPACITOR-B (CHIP)	0.010 16V K RECT.	チ ッ プ セ ラ (B)		01
C545	US662470	CERAMIC CAPACITOR-B (CHIP)	470P 50V K RECT.	チ ッ プ セ ラ (B)		01
C546	US634100	CERAMIC CAPACITOR-B (CHIP)	0.010 16V K RECT.	チ ッ プ セ ラ (B)		01
C547	US662470	CERAMIC CAPACITOR-B (CHIP)	470P 50V K RECT.	チ ッ プ セ ラ (B)		01
C548	US634100	CERAMIC CAPACITOR-B (CHIP)	0.010 16V K RECT.	チ ッ プ セ ラ (B)		01
C549	US662470	CERAMIC CAPACITOR-B (CHIP)	470P 50V K RECT.	チ ッ プ セ ラ (B)		01
C550	US634100	CERAMIC CAPACITOR-B (CHIP)	0.010 16V K RECT.	チ ッ プ セ ラ (B)		01
C551	UF037100	ELECTROLYTIC CAP. (CHIP)	10 16V	チ ッ プ ケ ミ コ ン		
C553	US662470	CERAMIC CAPACITOR-B (CHIP)	470P 50V K RECT.	チ ッ プ セ ラ (B)		01
C554	US662470	CERAMIC CAPACITOR-B (CHIP)	470P 50V K RECT.	チ ッ プ セ ラ (B)		01

*: New Parts

RANK: Japan only

DM

REF NO.	PART NO.	DESCRIPTION	部 品 名	REMARKS	QTY	RANK
C920	US635100	CERAMIC CAPACITOR-F (CHIP)	0.100 16V Z RECT.	チップセラ (F)		
C921	UF037100	ELECTROLYTIC CAP. (CHIP)	10 16V	チップケミコン		
C922	US635100	CERAMIC CAPACITOR-F (CHIP)	0.100 16V Z RECT.	チップセラ (F)		
C923	V9410700	ELECTROLYTIC CAP.-BP(CHIP)	1 50V RVB-50V010MU	チップ B P コン		
C924	V9410700	ELECTROLYTIC CAP.-BP(CHIP)	1 50V RVB-50V010MU	チップ B P コン		
C925	US635100	CERAMIC CAPACITOR-F (CHIP)	0.100 16V Z RECT.	チップセラ (F)		
C926	US663100	CERAMIC CAPACITOR-B (CHIP)	1000P 50V K RECT.	チップセラ (B)		
-929	US663100	CERAMIC CAPACITOR-B (CHIP)	1000P 50V K RECT.	チップセラ (B)		
C930	US635100	CERAMIC CAPACITOR-F (CHIP)	0.100 16V Z RECT.	チップセラ (F)		
* C933	US642180	CERAMIC CAPACITOR-CH (CHIP)	180P 25V J RECT.	チップセラ (C H)		
* -936	US642180	CERAMIC CAPACITOR-CH (CHIP)	180P 25V J RECT.	チップセラ (C H)		
C937	RD45000R	CHIP RESISTOR 1/16W	0.00 63M J RECT.	チ ッ プ 抵 抗		01
C938	RD45000R	CHIP RESISTOR 1/16W	0.00 63M J RECT.	チ ッ プ 抵 抗		01
* C939	US642180	CERAMIC CAPACITOR-CH (CHIP)	180P 25V J RECT.	チップセラ (C H)		
* -942	US642180	CERAMIC CAPACITOR-CH (CHIP)	180P 25V J RECT.	チップセラ (C H)		
C945	US635100	CERAMIC CAPACITOR-F (CHIP)	0.100 16V Z RECT.	チップセラ (F)		
C946	US635100	CERAMIC CAPACITOR-F (CHIP)	0.100 16V Z RECT.	チップセラ (F)		
C947	UF056470	ELECTROLYTIC CAP. (CHIP)	4.7 35V	チップケミコン		01
C948	US635100	CERAMIC CAPACITOR-F (CHIP)	0.100 16V Z RECT.	チップセラ (F)		
C949	US662100	CERAMIC CAPACITOR-CH (CHIP)	100P 50V J RECT.	チップセラ (C H)		
C950	US662100	CERAMIC CAPACITOR-CH (CHIP)	100P 50V J RECT.	チップセラ (C H)		
C951	UF056470	ELECTROLYTIC CAP. (CHIP)	4.7 35V	チップケミコン		01
-954	UF056470	ELECTROLYTIC CAP. (CHIP)	4.7 35V	チップケミコン		01
C955	US663100	CERAMIC CAPACITOR-B (CHIP)	1000P 50V K RECT.	チップセラ (B)		
C956	US663100	CERAMIC CAPACITOR-B (CHIP)	1000P 50V K RECT.	チップセラ (B)		
C957	US662100	CERAMIC CAPACITOR-CH (CHIP)	100P 50V J RECT.	チップセラ (C H)		
C958	US662100	CERAMIC CAPACITOR-CH (CHIP)	100P 50V J RECT.	チップセラ (C H)		
C959	US635100	CERAMIC CAPACITOR-F (CHIP)	0.100 16V Z RECT.	チップセラ (F)		
C960	US634100	CERAMIC CAPACITOR-B (CHIP)	0.010 16V K RECT.	チップセラ (B)		01
C961	US663100	CERAMIC CAPACITOR-B (CHIP)	1000P 50V K RECT.	チップセラ (B)		
C962	US663100	CERAMIC CAPACITOR-B (CHIP)	1000P 50V K RECT.	チップセラ (B)		
C963	US635100	CERAMIC CAPACITOR-F (CHIP)	0.100 16V Z RECT.	チップセラ (F)		
C964	US635100	CERAMIC CAPACITOR-F (CHIP)	0.100 16V Z RECT.	チップセラ (F)		
* C965	US633820	CERAMIC CAPACITOR-B (CHIP)	8200P 16V K RECT.	チップセラ (B)		
* C966	US633820	CERAMIC CAPACITOR-B (CHIP)	8200P 16V K RECT.	チップセラ (B)		
C967	V9410700	ELECTROLYTIC CAP.-BP(CHIP)	1 50V RVB-50V010MU	チップ B P コン		
C968	V9410700	ELECTROLYTIC CAP.-BP(CHIP)	1 50V RVB-50V010MU	チップ B P コン		
C969	UF03810R	ELECTROLYTIC CAP. (CHIP)	100 16V	チップケミコン		01
C970	UF13822R	ELECTROLYTIC CAP. (CHIP)	220 16V	チップケミコン		01
* C971	UF138680	ELECTROLYTIC CAP. (CHIP)	680 16V	チップケミコン		
C974	US635100	CERAMIC CAPACITOR-F (CHIP)	0.100 16V Z RECT.	チップセラ (F)		
C975	US635100	CERAMIC CAPACITOR-F (CHIP)	0.100 16V Z RECT.	チップセラ (F)		
C977	US635100	CERAMIC CAPACITOR-F (CHIP)	0.100 16V Z RECT.	チップセラ (F)		
C978	US635100	CERAMIC CAPACITOR-F (CHIP)	0.100 16V Z RECT.	チップセラ (F)		
C979	US663100	CERAMIC CAPACITOR-B (CHIP)	1000P 50V K RECT.	チップセラ (B)		
-989	US663100	CERAMIC CAPACITOR-B (CHIP)	1000P 50V K RECT.	チップセラ (B)		
C990	US635100	CERAMIC CAPACITOR-F (CHIP)	0.100 16V Z RECT.	チップセラ (F)		
-993	US635100	CERAMIC CAPACITOR-F (CHIP)	0.100 16V Z RECT.	チップセラ (F)		
C2000	US635100	CERAMIC CAPACITOR-F (CHIP)	0.100 16V Z RECT.	チップセラ (F)		
-2214	US635100	CERAMIC CAPACITOR-F (CHIP)	0.100 16V Z RECT.	チップセラ (F)		
CN1	WC19920R	CONNECTOR, FFC/FPC	52808 17P TE	F F C / F P C コネクタ		01
CN2	VT388700	CONNECTOR BASE PIN	PH 6P TE	ベ ー ス 付 ポ ス ト		
CN3	VT388600	CONNECTOR BASE PIN	PH 5P TE	ベ ー ス 付 ポ ス ト		
CN5	VT388300	CONNECTOR BASE PIN	PH 2P TE	ベ ー ス 付 ポ ス ト		
CN200	LB933060	BASE POST CONNECTOR	VH 6P SE	ベ ー ス ポ ス ト		
CN201	VT388500	CONNECTOR BASE PIN	PH 4P TE	ベ ー ス 付 ポ ス ト		
CN202	WA245700	USB CONNECTOR	YKF45-0027 4P SE	U S B コ ネ ク タ	USB [TO DEVICE]	02
CN203	V902080R	USB CONNECTOR	4P SE B-TYPE	U S B コ ネ ク タ B	USB [TO HOST]	02
CN204	VT388700	CONNECTOR BASE PIN	PH 6P TE	ベ ー ス 付 ポ ス ト		
CN205	VT388800	CONNECTOR BASE PIN	PH 7P TE	ベ ー ス 付 ポ ス ト		
CN206	VT388800	CONNECTOR BASE PIN	PH 7P TE	ベ ー ス 付 ポ ス ト		
CN208	WC199000	FMN CONNECTOR	FMN 40P TE	F M N コ ネ ク タ ー		
CN400	VT389300	CONNECTOR BASE PIN	PH 12P TE	ベ ー ス 付 ポ ス ト		
CN800	WG870200	DIMM SOCKET	DMM-168FLAA2-3A13N	D I M M ソ ケ ッ ト	DIMM (168-pin)	05
CN801	WG870200	DIMM SOCKET	DMM-168FLAA2-3A13N	D I M M ソ ケ ッ ト	DIMM (168-pin)	05
CN900	V902830R	CONNECTOR, FFC/FPC	52808-2471 24P TE	F F C / F P C コネクタ		02
D1	VS20110R	DIODE	D1F60 1A 600V TP	チ ッ プ ダ イ オ ー ド		01
D2	VR49650R	DIODE	MA2J1110GL TP	チ ッ プ ダ イ オ ー ド		01
-7	VR49650R	DIODE	MA2J1110GL TP	チ ッ プ ダ イ オ ー ド		01
D2	VT332900	DIODE	1SS355 TE-17 TP	ダ イ オ ー ド		

*: New Parts

RANK: Japan only

DM

REF NO.	PART NO.	DESCRIPTION	部 品 名	REMARKS	QTY	RANK
-7	VT332900	DIODE	1SS355 TE-17 TP	ダイオード		
D2	WG139300	DIODE	KDS4148U-RTK/P TE	ダイオード		
-7	WG139300	DIODE	KDS4148U-RTK/P TE	ダイオード		
D500	VS20110R	DIODE	D1F60 1A 600V TP	チップダイオード		01
-502	VS20110R	DIODE	D1F60 1A 600V TP	チップダイオード		01
D900	VR49650R	DIODE	MA2J1110GL TP	チップダイオード		01
-903	VR49650R	DIODE	MA2J1110GL TP	チップダイオード		01
D900	VT332900	DIODE	1SS355 TE-17 TP	ダイオード		
-903	VT332900	DIODE	1SS355 TE-17 TP	ダイオード		
D900	WG139300	DIODE	KDS4148U-RTK/P TE	ダイオード		
-903	WG139300	DIODE	KDS4148U-RTK/P TE	ダイオード		
D904	VS20110R	DIODE	D1F60 1A 600V TP	チップダイオード		01
D905	VS20110R	DIODE	D1F60 1A 600V TP	チップダイオード		01
D906	VR49650R	DIODE	MA2J1110GL TP	チップダイオード		01
-911	VR49650R	DIODE	MA2J1110GL TP	チップダイオード		01
D906	VT332900	DIODE	1SS355 TE-17 TP	ダイオード		
-911	VT332900	DIODE	1SS355 TE-17 TP	ダイオード		
D906	WG139300	DIODE	KDS4148U-RTK/P TE	ダイオード		
-911	WG139300	DIODE	KDS4148U-RTK/P TE	ダイオード		
EM1	WE94560R	EMI FILTER (CHIP)	NFM21CC223R1H3D	エミフィルチップ		01
-4	WE94560R	EMI FILTER (CHIP)	NFM21CC223R1H3D	エミフィルチップ		01
EM200	WE94560R	EMI FILTER (CHIP)	NFM21CC223R1H3D	エミフィルチップ		01
-203	WE94560R	EMI FILTER (CHIP)	NFM21CC223R1H3D	エミフィルチップ		01
EM900	WE94560R	EMI FILTER (CHIP)	NFM21CC223R1H3D	エミフィルチップ		01
EM901	WE94560R	EMI FILTER (CHIP)	NFM21CC223R1H3D	エミフィルチップ		01
* IC1	X9901A00	IC	R3112N291C-TR-F	I	C	SYSTEM RESET
IC2	X7820A00	IC	BA18BC0FP-E2	I	C	REGULATOR +1.8V
IC3	X2890B00	IC	HD6417727F160CV	I	C	CPU (MAIN)
IC4	X3098A00	IC	SN74AHC14PWR	I	C	INVERTER
IC4	X6688A0R	IC	SN74LV14APWR	I	C	
IC4	XV890B0R	IC	TC74VHC14FT(EL,K)	I	C	
IC5	X3098A00	IC	SN74AHC14PWR	I	C	INVERTER
IC5	X6688A0R	IC	SN74LV14APWR	I	C	
IC5	XV890B0R	IC	TC74VHC14FT(EL,K)	I	C	
IC6	X5647A00	IC	SN74LV32APWR	I	C	OR
IC7	X3098A00	IC	SN74AHC14PWR	I	C	INVERTER
IC7	X6688A0R	IC	SN74LV14APWR	I	C	
IC7	XV890B0R	IC	TC74VHC14FT(EL,K)	I	C	
* IC8	X9323A00	IC	DS99R103TSQX/NOPB	I	C	LVDS
IC9	XW814A0R	IC	TC7SET32FU(TE85L,F)	I	C	OR
* IC10	X9326D00	IC	S29GL256N10TFI020	I	C	FLASH ROM 256M PROG-L
* IC11	X9327D00	IC	S29GL256N10TFI020	I	C	FLASH ROM 256M PROG-H
IC12	X4942A0R	IC	MT48LC16M16A2P-75	I	C	SDRAM 256M
IC12	X4943B00	IC	W9825G6DH-75	I	C	
IC12	X6833A00	IC	EDS2516ADTA-75-E	I	C	
* IC12	X9556A00	IC	M12L2561616A-7TG	I	C	SDRAM 256M
IC13	X4942A0R	IC	MT48LC16M16A2P-75	I	C	
IC13	X4943B00	IC	W9825G6DH-75	I	C	
IC13	X6833A00	IC	EDS2516ADTA-75-E	I	C	
* IC13	X9556A00	IC	M12L2561616A-7TG	I	C	
* IC14	X9328100	IC	MR27T6402L-1LWTNZ03D	I	C	P2ROM 64M DATA
* IC15	X9697A00	IC	MX29LV640DBTC-90G	I	C	FLASH ROM 64M BACKUP
IC16	XZ287A0R	IC	SN74LVC245APWR	I	C	TRANSCEIVER
-19	XZ287A0R	IC	SN74LVC245APWR	I	C	TRANSCEIVER
IC20	X2377A0R	IC	SN74LV21APWR	I	C	AND
* IC20	X5542A00	IC	TC74VHC21FT(EL)	I	C	
IC21	XZ287A0R	IC	SN74LVC245APWR	I	C	TRANSCEIVER
IC22	XZ287A0R	IC	SN74LVC245APWR	I	C	TRANSCEIVER
IC23	X5074A00	IC	SN74LV273APWR	I	C	D-FF
IC23	X7942B00	IC	TC74VHC273FT(EL,K)	I	C	
IC24	X4963A0R	IC	HD74LVC139TELL-E	I	C	DECODER
IC24	X7227A00	IC	SN74LVC139APWR	I	C	
IC25	X4963A0R	IC	HD74LVC139TELL-E	I	C	DECODER
IC25	X7227A00	IC	SN74LVC139APWR	I	C	
IC27	XW633A0R	IC	TC7SH32FU(TE85L)	I	C	OR
IC200	X2709A0R	IC	SN74AHCT245PWR	I	C	TRANSCEIVER
IC200	XT744B0R	IC	TC74VHCT245AFT	I	C	
IC201	X3693A0R	IC	SN74LV245APWR	I	C	TRANSCEIVER
IC201	XU797B00	IC	TC74VHC245FT(EL,K)	I	C	
IC202	XR680A00	IC	TC7SH08FU(TE85L)	I	C	AND

*: New Parts

RANK: Japan only

DM

REF NO.	PART NO.	DESCRIPTION	部	品	名	REMARKS	QTY	RANK
IC203	X2688A0R	IC	S1L52502F24J200		C	DGA (GATE ARRAY)		9
IC204	X2760C00	IC	K4S641632K-UC75000		C	} SDRAM 64M		07
IC204	X7753B00	IC	IS42S16400D-7TL		C			
IC204	XZ414D00	IC	W9864G6GH-7		C	} MAT (CPLD)		08
IC205	X6046B0R	IC	LC4256V-75TN100		C			
IC206	X7951A00	IC	BD6517F-E2		C	HIGH SIDE SWITCH		
* IC207	X9073A00	IC	ISP1761BE,557		C	USB2.0 HOST CONTROLLER		
IC208	X6155A0R	IC	PCA9564PW,118-PBF		C	PCI BUS CONTROLLER		
IC209	XR680A00	IC	TC7SH08FU(TE85L,JF)		C	AND		
IC210	X7029A00	IC	DM9000AEP		C	LAN CONTROLLER		9
IC211	XW633A0R	IC	TC7SH32FU(TE85L,JF)		C	OR		
IC212	X5405A00	IC	SN74LVC32APWR		C	OR		
IC213	X5825A00	IC	SN74LVC1G32DCKR		C	OR GATE		01
IC400	XQ805A00	IC	TC7WU04FU(TE12L,F)		C	INVERTER		
IC401	XQ805A00	IC	TC7WU04FU(TE12L,F)		C	INVERTER		
IC402	X6356B00	IC	YGV628B-VZ		C	RGB CONTROLLER AVDP7		
IC403	X2590B0R	IC	W9816G6CH-7		C	} SDRAM 16M		06
IC403	X5217A00	IC	IS42S16100C1-7TLTR		C			
IC403	X5693B00	IC	M12L16161A-7TG		C	} D-FF		02
IC404	X6536A0R	IC	TC74ACT74FT(EL)		C			
* IC404	X9486A00	IC	SN74ACT74PWR		C			
IC405	X7703A00	IC	TC7WT126FU(TE12L)		C	BUFFER		02
IC406	X2314A00	IC	MB3516APF-G-BND-EF		C	RGB ENCODER		4
IC500	X7700A00	IC	BA15BC0FP-E2		C	REGULATOR +1.5V		
IC501	X7700A00	IC	BA15BC0FP-E2		C	REGULATOR +1.5V		
IC502	X7074A00	IC	SN74LVC138APWR		C	DECODER		
IC503	X4195A0R	IC	S1L50553F21Y000		C	MCI (GATE ARRAY)		5
IC504	X9292A00	IC	R1172H121D-T1-F		C	REGULATOR +1.2V		
IC505	X7376B00	IC	T6TZ2XBG-0002		C	SWP51B		
IC506	X7376B00	IC	T6TZ2XBG-0002		C	SWP51B		
* IC507	X8924A00	IC	R5S72060W200FPV		C	CPU (SUB)		
IC508	X0176C00	IC	W9864G2GH-7		C	} SDRAM 64M		
IC508	X4627C00	IC	M12L64322A-7TG		C			
* IC508	X4629B00	IC	IS42S32200C1-7TL		C	} SDRAM 64M		
IC509	X0176C00	IC	W9864G2GH-7		C			
IC509	X4627C00	IC	M12L64322A-7TG		C	} SDRAM 64M		
IC509	X4629B00	IC	IS42S32200C1-7TL		C			
IC510	X3098A00	IC	SN74AHC14PWR		C	INVERTER		
IC510	X6688A0R	IC	SN74LV14APWR		C	} INVERTER		01
IC510	XV890B0R	IC	TC74VHC14FT(EL,K)		C			01
IC511	X2590B0R	IC	W9816G6CH-7		C	SDRAM 16M		06
IC511	X5217A00	IC	IS42S16100C1-7TLTR		C	} SDRAM 16M		
IC511	X5693B00	IC	M12L16161A-7TG		C			
IC512	X2590B0R	IC	W9816G6CH-7		C	SDRAM 16M		06
IC512	X5217A00	IC	IS42S16100C1-7TLTR		C	} SDRAM 128M		
IC512	X5693B00	IC	M12L16161A-7TG		C			
* IC513	X9426A00	IC	M12L128324A-7TG		C	} SDRAM 128M		
* IC513	X9427A00	IC	W9812G2GH-75		C			
* IC514	X9329100	IC	MR27V802F-10TTNZ03		C	MASK ROM 8M		
* IC800	X9330100	IC	MR26T51203L-105TM0		C	MASK ROM 512M WAVE L1 ※1		
* IC801	X9331100	IC	MR26T51203L-106TM0		C	MASK ROM 512M WAVE L2 ※1		
* IC802	X9332100	IC	MR26T51203L-107TM0		C	MASK ROM 512M WAVE H1 ※1		
* IC803	X9333100	IC	MR26T51203L-108TM0		C	MASK ROM 512M WAVE H2 ※1		
* IC804	YA421100	IC	MR26V51252R-100TA0		C	MASK ROM 512M WAVE L1 ※2		
* IC805	YA422100	IC	MR26V51252R-101TA0		C	MASK ROM 512M WAVE L2 ※2		
* IC806	YA423100	IC	MR26V51252R-102TA0		C	MASK ROM 512M WAVE H1 ※2		
* IC807	YA424100	IC	MR26V51252R-103TA0		C	MASK ROM 512M WAVE H2 ※2		
IC808	XZ287A0R	IC	SN74LVC245APWR		C	TRANSCEIVER		1
-811	XZ287A0R	IC	SN74LVC245APWR		C	TRANSCEIVER		1
IC812	XR680A00	IC	TC7SH08FU(TE85L)		C	AND		
IC813	XR680A00	IC	TC7SH08FU(TE85L)		C	AND		
IC900	X8324A00	IC	AK4396VF-E2		C	DAC		06
IC901	X8324A00	IC	AK4396VF-E2		C	DAC		06
IC902	X5219A0R	IC	AK5381VT-E2		C	ADC		05
IC903	X3505A00	IC	NJM2068M-D(TE2)		C	} OP AMP		
IC903	X5482A00	IC	NE5532DR		C			
IC904	X3505A00	IC	NJM2068M-D(TE2)		C	} OP AMP		
IC904	X5482A00	IC	NE5532DR		C			
IC906	X3505A00	IC	NJM2068M-D(TE2)		C	} OP AMP		
IC906	X5482A00	IC	NE5532DR		C			

*: New Parts

RANK: Japan only

DM

REF NO.	PART NO.	DESCRIPTION		部 品 名	REMARKS	QTY	RANK
IC908	XZ642A00	IC	TAR5S33(TE85L,F)	I C	REGULATOR +3.3V		
IC909	XS534A00	IC	NJM78M05DL1A	I C	REGULATOR +5V		
JK200	WG468100	MODULAR CONNECTOR	8P RJSE-1E08T089A	モジュラーコネクタ	LAN		05
L1	VY65720R	CHIP INDUCTANCE	600 BK1608HM601-T	チップインダクタ			01
-15	VY65720R	CHIP INDUCTANCE	600 BK1608HM601-T	チップインダクタ			01
L17	VR57990R	CHIP INDUCTANCE	BK2125 HS601-T	チップインダクタ			01
L20	WG834800	COIL	DLW21HN900SQ2L	コイル			
L23	RD350001	CHIP RESISTOR 1/16W	0 63M J RECT.	チップ抵抗			01
-26	RD350001	CHIP RESISTOR 1/16W	0 63M J RECT.	チップ抵抗			01
* L27	WH559500	CHIP INDUCTANCE	BLM18PG471SN1D	チップインダクタ			
* -52	WH559500	CHIP INDUCTANCE	BLM18PG471SN1D	チップインダクタ			
L53	RD350001	CHIP RESISTOR 1/16W	0 63M J RECT.	チップ抵抗			01
-60	RD350001	CHIP RESISTOR 1/16W	0 63M J RECT.	チップ抵抗			01
* L61	WH559500	CHIP INDUCTANCE	BLM18PG471SN1D	チップインダクタ			
L62	VY65720R	CHIP INDUCTANCE	600 BK1608HM601-T	チップインダクタ			01
* L63	WH559500	CHIP INDUCTANCE	BLM18PG471SN1D	チップインダクタ			
L200	RD350001	CHIP RESISTOR 1/16W	0 63M J RECT.	チップ抵抗			01
-203	RD350001	CHIP RESISTOR 1/16W	0 63M J RECT.	チップ抵抗			01
L204	WG834800	COIL	DLW21HN900SQ2L	コイル			
L205	V8901200	CHIP SOLID INDUCTANCE	BLM21PG221SN1D	チップソリッドインダ			01
L206	WG834800	COIL	DLW21HN900SQ2L	コイル			
L207	WG834800	COIL	DLW21HN900SQ2L	コイル			
* L209	WH559500	CHIP INDUCTANCE	BLM18PG471SN1D	チップインダクタ			
* L210	WH559500	CHIP INDUCTANCE	BLM18PG471SN1D	チップインダクタ			
L215	VY65720R	CHIP INDUCTANCE	600 BK1608HM601-T	チップインダクタ			01
-220	VY65720R	CHIP INDUCTANCE	600 BK1608HM601-T	チップインダクタ			01
* L222	WH559500	CHIP INDUCTANCE	BLM18PG471SN1D	チップインダクタ			
* -275	WH559500	CHIP INDUCTANCE	BLM18PG471SN1D	チップインダクタ			
* L400	WH559500	CHIP INDUCTANCE	BLM18PG471SN1D1	チップインダクタ			
* -402	WH559500	CHIP INDUCTANCE	BLM18PG471SN1D1	チップインダクタ			
L407	VR57990R	CHIP INDUCTANCE	BK2125 HS601-T	チップインダクタ			01
L409	VR57990R	CHIP INDUCTANCE	BK2125 HS601-T	チップインダクタ			01
L410	RD350001	CHIP RESISTOR 1/16W	0 63M J RECT.	チップ抵抗			01
* L412	WH559500	CHIP INDUCTANCE	BLM18PG471SN1D	チップインダクタ			
* -430	WH559500	CHIP INDUCTANCE	BLM18PG471SN1D	チップインダクタ			
L502	VY65720R	CHIP INDUCTANCE	600 BK1608HM601-T	チップインダクタ			01
L503	V2747000	CHIP INDUCTANCE	BLM18PG600SN1	チップインダクタ			
L512	RD350001	CHIP RESISTOR 1/16W	0 63M J RECT.	チップ抵抗			01
* L513	WH559500	CHIP INDUCTANCE	BLM18PG471SN1D	チップインダクタ			
L516	RD350001	CHIP RESISTOR 1/16W	0 63M J RECT.	チップ抵抗			01
* L517	WH559500	CHIP INDUCTANCE	BLM18PG471SN1D	チップインダクタ			
* L520	WH559500	CHIP INDUCTANCE	BLM18PG471SN1D	チップインダクタ			
* -528	WH559500	CHIP INDUCTANCE	BLM18PG471SN1D	チップインダクタ			
L529	RD350001	CHIP RESISTOR 1/16W	0 63M J RECT.	チップ抵抗			01
-537	RD350001	CHIP RESISTOR 1/16W	0 63M J RECT.	チップ抵抗			01
* L538	WH559500	CHIP INDUCTANCE	BLM18PG471SN1D	チップインダクタ			
* -572	WH559500	CHIP INDUCTANCE	BLM18PG471SN1D	チップインダクタ			
* L804	WH559500	CHIP INDUCTANCE	BLM18PG471SN1D	チップインダクタ			
* L805	WH559500	CHIP INDUCTANCE	BLM18PG471SN1D	チップインダクタ			
* L812	WH559500	CHIP INDUCTANCE	BLM18PG471SN1D	チップインダクタ			
* -865	WH559500	CHIP INDUCTANCE	BLM18PG471SN1D	チップインダクタ			
L900	VY65720R	CHIP INDUCTANCE	600 BK1608HM601-T	チップインダクタ			01
-910	VY65720R	CHIP INDUCTANCE	600 BK1608HM601-T	チップインダクタ			01
R1	RD456470	CHIP RESISTOR 1/16W	4.7K 63M J RECT.	チップ抵抗			
R2	RD455100	CHIP RESISTOR 1/16W	100.0 63M J RECT.	チップ抵抗			
R3	RD456100	CHIP RESISTOR 1/16W	1.0K 63M J RECT.	チップ抵抗			
-5	RD456100	CHIP RESISTOR 1/16W	1.0K 63M J RECT.	チップ抵抗			
R11	RD458470	CHIP RESISTOR 1/16W	470.0K 63M J RECT.	チップ抵抗			
R12	RD456100	CHIP RESISTOR 1/16W	1.0K 63M J RECT.	チップ抵抗			
R13	RD458470	CHIP RESISTOR 1/16W	470.0K 63M J RECT.	チップ抵抗			
-15	RD458470	CHIP RESISTOR 1/16W	470.0K 63M J RECT.	チップ抵抗			
R16	RD456100	CHIP RESISTOR 1/16W	1.0K 63M J RECT.	チップ抵抗			
-18	RD456100	CHIP RESISTOR 1/16W	1.0K 63M J RECT.	チップ抵抗			
R19	RD456470	CHIP RESISTOR 1/16W	4.7K 63M J RECT.	チップ抵抗			
R20	RD458100	CHIP RESISTOR 1/16W	100.0K 63M J RECT.	チップ抵抗			
R21	RD458100	CHIP RESISTOR 1/16W	100.0K 63M J RECT.	チップ抵抗			
R23	RD45000R	CHIP RESISTOR 1/16W	0.00 63M J RECT.	チップ抵抗			01
R24	RD457100	CHIP RESISTOR 1/16W	10.0K 63M J RECT.	チップ抵抗			
R25	RD45522R	CHIP RESISTOR 1/16W	220.0 63M J RECT.	チップ抵抗			01
-28	RD45522R	CHIP RESISTOR 1/16W	220.0 63M J RECT.	チップ抵抗			01

*: New Parts

RANK: Japan only

DM

REF NO.	PART NO.	DESCRIPTION		部	品	名	REMARKS	QTY	RANK
R29	RD457100	CHIP RESISTOR 1/16W	10.0K 63M J RECT.	チ	ッ	ブ 抵 抗			
R32	RD457100	CHIP RESISTOR 1/16W	10.0K 63M J RECT.	チ	ッ	ブ 抵 抗			
R33	RD457100	CHIP RESISTOR 1/16W	10.0K 63M J RECT.	チ	ッ	ブ 抵 抗			
R34	RD45522R	CHIP RESISTOR 1/16W	220.0 63M J RECT.	チ	ッ	ブ 抵 抗			01
R35	RD45522R	CHIP RESISTOR 1/16W	220.0 63M J RECT.	チ	ッ	ブ 抵 抗			01
R40	RD45000R	CHIP RESISTOR 1/16W	0.00 63M J RECT.	チ	ッ	ブ 抵 抗			01
R41	RD45515R	CHIP RESISTOR 1/16W	150.0 63M J RECT.	チ	ッ	ブ 抵 抗			01
R45	RD457100	CHIP RESISTOR 1/16W	10.0K 63M J RECT.	チ	ッ	ブ 抵 抗			
-47	RD457100	CHIP RESISTOR 1/16W	10.0K 63M J RECT.	チ	ッ	ブ 抵 抗			
R48	RD454680	CHIP RESISTOR 1/16W	68.0 63M J RECT.	チ	ッ	ブ 抵 抗			01
R49	RD457100	CHIP RESISTOR 1/16W	10.0K 63M J RECT.	チ	ッ	ブ 抵 抗			
R50	RD454680	CHIP RESISTOR 1/16W	68.0 63M J RECT.	チ	ッ	ブ 抵 抗			01
-53	RD454680	CHIP RESISTOR 1/16W	68.0 63M J RECT.	チ	ッ	ブ 抵 抗			01
R54	RD457220	CHIP RESISTOR 1/16W	22.0K 63M J RECT.	チ	ッ	ブ 抵 抗			01
R56	RD454680	CHIP RESISTOR 1/16W	68.0 63M J RECT.	チ	ッ	ブ 抵 抗			01
R57	RD457220	CHIP RESISTOR 1/16W	22.0K 63M J RECT.	チ	ッ	ブ 抵 抗			01
R58	RD454680	CHIP RESISTOR 1/16W	68.0 63M J RECT.	チ	ッ	ブ 抵 抗			01
-60	RD454680	CHIP RESISTOR 1/16W	68.0 63M J RECT.	チ	ッ	ブ 抵 抗			01
R61	RD457220	CHIP RESISTOR 1/16W	22.0K 63M J RECT.	チ	ッ	ブ 抵 抗			01
R62	RD454680	CHIP RESISTOR 1/16W	68.0 63M J RECT.	チ	ッ	ブ 抵 抗			01
-64	RD454680	CHIP RESISTOR 1/16W	68.0 63M J RECT.	チ	ッ	ブ 抵 抗			01
R65	RD457220	CHIP RESISTOR 1/16W	22.0K 63M J RECT.	チ	ッ	ブ 抵 抗			01
R66	RD454680	CHIP RESISTOR 1/16W	68.0 63M J RECT.	チ	ッ	ブ 抵 抗			01
-68	RD454680	CHIP RESISTOR 1/16W	68.0 63M J RECT.	チ	ッ	ブ 抵 抗			01
R69	RD45000R	CHIP RESISTOR 1/16W	0.00 63M J RECT.	チ	ッ	ブ 抵 抗			01
R70	RD454680	CHIP RESISTOR 1/16W	68.0 63M J RECT.	チ	ッ	ブ 抵 抗			01
R71	RD454680	CHIP RESISTOR 1/16W	68.0 63M J RECT.	チ	ッ	ブ 抵 抗			01
R73	RD454680	CHIP RESISTOR 1/16W	68.0 63M J RECT.	チ	ッ	ブ 抵 抗			01
R76	RD454470	CHIP RESISTOR 1/16W	47.0 63M J RECT.	チ	ッ	ブ 抵 抗			01
R77	RD454680	CHIP RESISTOR 1/16W	68.0 63M J RECT.	チ	ッ	ブ 抵 抗			01
R78	RD45000R	CHIP RESISTOR 1/16W	0.00 63M J RECT.	チ	ッ	ブ 抵 抗			01
R79	RD454680	CHIP RESISTOR 1/16W	68.0 63M J RECT.	チ	ッ	ブ 抵 抗			01
R80	RD457100	CHIP RESISTOR 1/16W	10.0K 63M J RECT.	チ	ッ	ブ 抵 抗			
R81	RD457100	CHIP RESISTOR 1/16W	10.0K 63M J RECT.	チ	ッ	ブ 抵 抗			
R82	RD454680	CHIP RESISTOR 1/16W	68.0 63M J RECT.	チ	ッ	ブ 抵 抗			01
R83	RD454680	CHIP RESISTOR 1/16W	68.0 63M J RECT.	チ	ッ	ブ 抵 抗			01
R84	RD45000R	CHIP RESISTOR 1/16W	0.00 63M J RECT.	チ	ッ	ブ 抵 抗			01
R85	RD457100	CHIP RESISTOR 1/16W	10.0K 63M J RECT.	チ	ッ	ブ 抵 抗			
R86	RD457220	CHIP RESISTOR 1/16W	22.0K 63M J RECT.	チ	ッ	ブ 抵 抗			01
R87	RD45000R	CHIP RESISTOR 1/16W	0.00 63M J RECT.	チ	ッ	ブ 抵 抗			01
R89	RD457100	CHIP RESISTOR 1/16W	10.0K 63M J RECT.	チ	ッ	ブ 抵 抗			
-91	RD457100	CHIP RESISTOR 1/16W	10.0K 63M J RECT.	チ	ッ	ブ 抵 抗			
R92	RD454680	CHIP RESISTOR 1/16W	68.0 63M J RECT.	チ	ッ	ブ 抵 抗			01
R93	RD457100	CHIP RESISTOR 1/16W	10.0K 63M J RECT.	チ	ッ	ブ 抵 抗			
R94	RD45000R	CHIP RESISTOR 1/16W	0.00 63M J RECT.	チ	ッ	ブ 抵 抗			01
R95	RD45515R	CHIP RESISTOR 1/16W	150.0 63M J RECT.	チ	ッ	ブ 抵 抗			01
R96	RD456100	CHIP RESISTOR 1/16W	1.0K 63M J RECT.	チ	ッ	ブ 抵 抗			
R99	RD457100	CHIP RESISTOR 1/16W	10.0K 63M J RECT.	チ	ッ	ブ 抵 抗			
R103	RD45000R	CHIP RESISTOR 1/16W	0.00 63M J RECT.	チ	ッ	ブ 抵 抗			01
R106	RD456470	CHIP RESISTOR 1/16W	4.7K 63M J RECT.	チ	ッ	ブ 抵 抗			
R107	RD457100	CHIP RESISTOR 1/16W	10.0K 63M J RECT.	チ	ッ	ブ 抵 抗			
R108	RD454680	CHIP RESISTOR 1/16W	68.0 63M J RECT.	チ	ッ	ブ 抵 抗			01
-110	RD454680	CHIP RESISTOR 1/16W	68.0 63M J RECT.	チ	ッ	ブ 抵 抗			01
R112	RD457220	CHIP RESISTOR 1/16W	22.0K 63M J RECT.	チ	ッ	ブ 抵 抗			01
R113	RD457220	CHIP RESISTOR 1/16W	22.0K 63M J RECT.	チ	ッ	ブ 抵 抗			01
R114	RD457100	CHIP RESISTOR 1/16W	10.0K 63M J RECT.	チ	ッ	ブ 抵 抗			
R115	RD454680	CHIP RESISTOR 1/16W	68.0 63M J RECT.	チ	ッ	ブ 抵 抗			01
R116	RD455100	CHIP RESISTOR 1/16W	100.0 63M J RECT.	チ	ッ	ブ 抵 抗			
R119	RD45747R	CHIP RESISTOR 1/16W	47.0K 63M J RECT.	チ	ッ	ブ 抵 抗			01
R120	RD458470	CHIP RESISTOR 1/16W	470.0K 63M J RECT.	チ	ッ	ブ 抵 抗			
-122	RD458470	CHIP RESISTOR 1/16W	470.0K 63M J RECT.	チ	ッ	ブ 抵 抗			
R123	RD45747R	CHIP RESISTOR 1/16W	47.0K 63M J RECT.	チ	ッ	ブ 抵 抗			01
R124	RD45747R	CHIP RESISTOR 1/16W	47.0K 63M J RECT.	チ	ッ	ブ 抵 抗			01
R138	RD454680	CHIP RESISTOR 1/16W	68.0 63M J RECT.	チ	ッ	ブ 抵 抗			01
R139	RD454680	CHIP RESISTOR 1/16W	68.0 63M J RECT.	チ	ッ	ブ 抵 抗			01
R143	RD455100	CHIP RESISTOR 1/16W	100.0 63M J RECT.	チ	ッ	ブ 抵 抗			
R145	RD455100	CHIP RESISTOR 1/16W	100.0 63M J RECT.	チ	ッ	ブ 抵 抗			
R148	RD454470	CHIP RESISTOR 1/16W	47.0 63M J RECT.	チ	ッ	ブ 抵 抗			01
R150	RD455100	CHIP RESISTOR 1/16W	100.0 63M J RECT.	チ	ッ	ブ 抵 抗			
R151	RD454680	CHIP RESISTOR 1/16W	68.0 63M J RECT.	チ	ッ	ブ 抵 抗			01

*: New Parts

RANK: Japan only

DM

REF NO.	PART NO.	DESCRIPTION		部	品	名	REMARKS	QTY	RANK
-154	RD454680	CHIP RESISTOR 1/16W	68.0 63M J RECT.	チ	ッ	ブ	抵抗		01
R155	RD455100	CHIP RESISTOR 1/16W	100.0 63M J RECT.	チ	ッ	ブ	抵抗		
R156	RD455100	CHIP RESISTOR 1/16W	100.0 63M J RECT.	チ	ッ	ブ	抵抗		
R157	RD45515R	CHIP RESISTOR 1/16W	150.0 63M J RECT.	チ	ッ	ブ	抵抗		01
R158	RD455100	CHIP RESISTOR 1/16W	100.0 63M J RECT.	チ	ッ	ブ	抵抗		
R159	RD45000R	CHIP RESISTOR 1/16W	0.00 63M J RECT.	チ	ッ	ブ	抵抗		01
R160	RD455100	CHIP RESISTOR 1/16W	100.0 63M J RECT.	チ	ッ	ブ	抵抗		
R161	RD455100	CHIP RESISTOR 1/16W	100.0 63M J RECT.	チ	ッ	ブ	抵抗		
R164	RD454680	CHIP RESISTOR 1/16W	68.0 63M J RECT.	チ	ッ	ブ	抵抗		01
-167	RD454680	CHIP RESISTOR 1/16W	68.0 63M J RECT.	チ	ッ	ブ	抵抗		01
R168	RD455100	CHIP RESISTOR 1/16W	100.0 63M J RECT.	チ	ッ	ブ	抵抗		
R169	RD45000R	CHIP RESISTOR 1/16W	0.00 63M J RECT.	チ	ッ	ブ	抵抗		01
-171	RD45000R	CHIP RESISTOR 1/16W	0.00 63M J RECT.	チ	ッ	ブ	抵抗		01
R172	RD454680	CHIP RESISTOR 1/16W	68.0 63M J RECT.	チ	ッ	ブ	抵抗		01
R173	RD45747R	CHIP RESISTOR 1/16W	47.0K 63M J RECT.	チ	ッ	ブ	抵抗		01
R174	RD454680	CHIP RESISTOR 1/16W	68.0 63M J RECT.	チ	ッ	ブ	抵抗		01
R175	RD454680	CHIP RESISTOR 1/16W	68.0 63M J RECT.	チ	ッ	ブ	抵抗		01
R177	RD457100	CHIP RESISTOR 1/16W	10.0K 63M J RECT.	チ	ッ	ブ	抵抗		
R200	RD45000R	CHIP RESISTOR 1/16W	0.00 63M J RECT.	チ	ッ	ブ	抵抗		01
-202	RD45000R	CHIP RESISTOR 1/16W	0.00 63M J RECT.	チ	ッ	ブ	抵抗		01
R203	RD456100	CHIP RESISTOR 1/16W	1.0K 63M J RECT.	チ	ッ	ブ	抵抗		
-205	RD456100	CHIP RESISTOR 1/16W	1.0K 63M J RECT.	チ	ッ	ブ	抵抗		
R206	RD350001	CHIP RESISTOR 1/16W	0 63M J RECT.	チ	ッ	ブ	抵抗		01
R208	RD350001	CHIP RESISTOR 1/16W	0 63M J RECT.	チ	ッ	ブ	抵抗		01
R209	RD350001	CHIP RESISTOR 1/16W	0 63M J RECT.	チ	ッ	ブ	抵抗		01
R210	RD454680	CHIP RESISTOR 1/16W	68.0 63M J RECT.	チ	ッ	ブ	抵抗		01
R220	RD45000R	CHIP RESISTOR 1/16W	0.00 63M J RECT.	チ	ッ	ブ	抵抗		01
R221	RD45000R	CHIP RESISTOR 1/16W	0.00 63M J RECT.	チ	ッ	ブ	抵抗		01
R222	RD457100	CHIP RESISTOR 1/16W	10.0K 63M J RECT.	チ	ッ	ブ	抵抗		
R223	RD454470	CHIP RESISTOR 1/16W	47.0 63M J RECT.	チ	ッ	ブ	抵抗		01
R224	RD454470	CHIP RESISTOR 1/16W	47.0 63M J RECT.	チ	ッ	ブ	抵抗		01
R231	RD458100	CHIP RESISTOR 1/16W	100.0K 63M J RECT.	チ	ッ	ブ	抵抗		
R233	RD454470	CHIP RESISTOR 1/16W	47.0 63M J RECT.	チ	ッ	ブ	抵抗		01
R235	RD454470	CHIP RESISTOR 1/16W	47.0 63M J RECT.	チ	ッ	ブ	抵抗		01
-238	RD454470	CHIP RESISTOR 1/16W	47.0 63M J RECT.	チ	ッ	ブ	抵抗		01
R241	RD457100	CHIP RESISTOR 1/16W	10.0K 63M J RECT.	チ	ッ	ブ	抵抗		
-243	RD457100	CHIP RESISTOR 1/16W	10.0K 63M J RECT.	チ	ッ	ブ	抵抗		
R245	RD457100	CHIP RESISTOR 1/16W	10.0K 63M J RECT.	チ	ッ	ブ	抵抗		
R246	RD454470	CHIP RESISTOR 1/16W	47.0 63M J RECT.	チ	ッ	ブ	抵抗		01
R254	RD456100	CHIP RESISTOR 1/16W	1.0K 63M J RECT.	チ	ッ	ブ	抵抗		
R255	RD459100	CHIP RESISTOR 1/16W	1.0M 63M J RECT.	チ	ッ	ブ	抵抗		
R259	RD456100	CHIP RESISTOR 1/16W	1.0K 63M J RECT.	チ	ッ	ブ	抵抗		
R262	RD457100	CHIP RESISTOR 1/16W	10.0K 63M J RECT.	チ	ッ	ブ	抵抗		
R264	RD45000R	CHIP RESISTOR 1/16W	0.00 63M J RECT.	チ	ッ	ブ	抵抗		01
R266	RF35712R	CHIP RESISTOR 1/16W	12.0K D 1608	チ	ッ	ブ	抵抗		01
-268	RF35712R	CHIP RESISTOR 1/16W	12.0K D 1608	チ	ッ	ブ	抵抗		01
R276	RD454680	CHIP RESISTOR 1/16W	68.0 63M J RECT.	チ	ッ	ブ	抵抗		01
-281	RD454680	CHIP RESISTOR 1/16W	68.0 63M J RECT.	チ	ッ	ブ	抵抗		01
R288	RD457100	CHIP RESISTOR 1/16W	10.0K 63M J RECT.	チ	ッ	ブ	抵抗		
R289	RD457100	CHIP RESISTOR 1/16W	10.0K 63M J RECT.	チ	ッ	ブ	抵抗		
R291	RD457100	CHIP RESISTOR 1/16W	10.0K 63M J RECT.	チ	ッ	ブ	抵抗		
R292	RD457100	CHIP RESISTOR 1/16W	10.0K 63M J RECT.	チ	ッ	ブ	抵抗		
R294	RD457100	CHIP RESISTOR 1/16W	10.0K 63M J RECT.	チ	ッ	ブ	抵抗		
R303	RD454470	CHIP RESISTOR 1/16W	47.0 63M J RECT.	チ	ッ	ブ	抵抗		01
R306	RD457100	CHIP RESISTOR 1/16W	10.0K 63M J RECT.	チ	ッ	ブ	抵抗		
R307	RD45000R	CHIP RESISTOR 1/16W	0.00 63M J RECT.	チ	ッ	ブ	抵抗		01
R311	RD45000R	CHIP RESISTOR 1/16W	0.00 63M J RECT.	チ	ッ	ブ	抵抗		01
R315	RD350001	CHIP RESISTOR 1/16W	0 63M J RECT.	チ	ッ	ブ	抵抗		01
R316	RF355100	CHIP RESISTOR 1/16W	100.0 D 1608	チ	ッ	ブ	抵抗		
-319	RF355100	CHIP RESISTOR 1/16W	100.0 D 1608	チ	ッ	ブ	抵抗		
R322	RF355100	CHIP RESISTOR 1/16W	100.0 D 1608	チ	ッ	ブ	抵抗		
-325	RF355100	CHIP RESISTOR 1/16W	100.0 D 1608	チ	ッ	ブ	抵抗		
R326	RD45000R	CHIP RESISTOR 1/16W	0.00 63M J RECT.	チ	ッ	ブ	抵抗		01
-329	RD45000R	CHIP RESISTOR 1/16W	0.00 63M J RECT.	チ	ッ	ブ	抵抗		01
R331	RD456100	CHIP RESISTOR 1/16W	1.0K 63M J RECT.	チ	ッ	ブ	抵抗		
R332	RD455100	CHIP RESISTOR 1/16W	100.0 63M J RECT.	チ	ッ	ブ	抵抗		
R333	RD456100	CHIP RESISTOR 1/16W	1.0K 63M J RECT.	チ	ッ	ブ	抵抗		
R334	RD456100	CHIP RESISTOR 1/16W	1.0K 63M J RECT.	チ	ッ	ブ	抵抗		
R335	RD454680	CHIP RESISTOR 1/16W	68.0 63M J RECT.	チ	ッ	ブ	抵抗		01
R336	RD456100	CHIP RESISTOR 1/16W	1.0K 63M J RECT.	チ	ッ	ブ	抵抗		

*: New Parts

RANK: Japan only

DM

REF NO.	PART NO.	DESCRIPTION		部	品	名	REMARKS	QTY	RANK
R337	RD454680	CHIP RESISTOR 1/16W	68.0 63M J RECT.	チ	ッ	ブ 抵 抗			01
R338	RD454470	CHIP RESISTOR 1/16W	47.0 63M J RECT.	チ	ッ	ブ 抵 抗			01
-340	RD454470	CHIP RESISTOR 1/16W	47.0 63M J RECT.	チ	ッ	ブ 抵 抗			01
R341	RD456560	CHIP RESISTOR 1/16W	5.6K 63M J RECT.	チ	ッ	ブ 抵 抗			01
R342	RF35668R	CHIP RESISTOR 1/16W	6.8K D 1608	チ	ッ	ブ 抵 抗			01
R343	RD456560	CHIP RESISTOR 1/16W	5.6K 63M J RECT.	チ	ッ	ブ 抵 抗			01
* R346	RD454100	CHIP RESISTOR 1/16W	10.0 63M J RECT.	チ	ッ	ブ 抵 抗			01
* R347	RD454100	CHIP RESISTOR 1/16W	10.0 63M J RECT.	チ	ッ	ブ 抵 抗			01
R348	RD454470	CHIP RESISTOR 1/16W	47.0 63M J RECT.	チ	ッ	ブ 抵 抗			01
-350	RD454470	CHIP RESISTOR 1/16W	47.0 63M J RECT.	チ	ッ	ブ 抵 抗			01
R351	RD454820	CHIP RESISTOR 1/16W	82.0 63M J RECT.	チ	ッ	ブ 抵 抗			01
R352	RD45000R	CHIP RESISTOR 1/16W	0.00 63M J RECT.	チ	ッ	ブ 抵 抗			01
-354	RD45000R	CHIP RESISTOR 1/16W	0.00 63M J RECT.	チ	ッ	ブ 抵 抗			01
R355	RD454470	CHIP RESISTOR 1/16W	47.0 63M J RECT.	チ	ッ	ブ 抵 抗			01
R356	RD454330	CHIP RESISTOR 1/16W	33.0 63M J RECT.	チ	ッ	ブ 抵 抗			01
-371	RD454330	CHIP RESISTOR 1/16W	33.0 63M J RECT.	チ	ッ	ブ 抵 抗			01
R373	RD454330	CHIP RESISTOR 1/16W	33.0 63M J RECT.	チ	ッ	ブ 抵 抗			01
R374	RD457100	CHIP RESISTOR 1/16W	10.0K 63M J RECT.	チ	ッ	ブ 抵 抗			01
R375	RD454470	CHIP RESISTOR 1/16W	47.0 63M J RECT.	チ	ッ	ブ 抵 抗			01
R377	RD454470	CHIP RESISTOR 1/16W	47.0 63M J RECT.	チ	ッ	ブ 抵 抗			01
R378	RD454680	CHIP RESISTOR 1/16W	68.0 63M J RECT.	チ	ッ	ブ 抵 抗			01
R380	RD457100	CHIP RESISTOR 1/16W	10.0K 63M J RECT.	チ	ッ	ブ 抵 抗			01
R381	RD457100	CHIP RESISTOR 1/16W	10.0K 63M J RECT.	チ	ッ	ブ 抵 抗			01
R382	RD454470	CHIP RESISTOR 1/16W	47.0 63M J RECT.	チ	ッ	ブ 抵 抗			01
R383	RD454470	CHIP RESISTOR 1/16W	47.0 63M J RECT.	チ	ッ	ブ 抵 抗			01
R384	RD454680	CHIP RESISTOR 1/16W	68.0 63M J RECT.	チ	ッ	ブ 抵 抗			01
R385	RD456470	CHIP RESISTOR 1/16W	4.7K 63M J RECT.	チ	ッ	ブ 抵 抗			01
R386	RD454470	CHIP RESISTOR 1/16W	47.0 63M J RECT.	チ	ッ	ブ 抵 抗			01
R387	RD454470	CHIP RESISTOR 1/16W	47.0 63M J RECT.	チ	ッ	ブ 抵 抗			01
R388	RD45000R	CHIP RESISTOR 1/16W	0.00 63M J RECT.	チ	ッ	ブ 抵 抗			01
R390	RD45512R	CHIP RESISTOR 1/16W	120.0 63M J RECT.	チ	ッ	ブ 抵 抗			01
-392	RD45512R	CHIP RESISTOR 1/16W	120.0 63M J RECT.	チ	ッ	ブ 抵 抗			01
R393	RD45000R	CHIP RESISTOR 1/16W	0.00 63M J RECT.	チ	ッ	ブ 抵 抗			01
-396	RD45000R	CHIP RESISTOR 1/16W	0.00 63M J RECT.	チ	ッ	ブ 抵 抗			01
R397	RD454680	CHIP RESISTOR 1/16W	68.0 63M J RECT.	チ	ッ	ブ 抵 抗			01
R398	RD454680	CHIP RESISTOR 1/16W	68.0 63M J RECT.	チ	ッ	ブ 抵 抗			01
R399	RD350001	CHIP RESISTOR 1/16W	0 63M J RECT.	チ	ッ	ブ 抵 抗			01
R400	RD459100	CHIP RESISTOR 1/16W	1.0M 63M J RECT.	チ	ッ	ブ 抵 抗			01
R401	RD459100	CHIP RESISTOR 1/16W	1.0M 63M J RECT.	チ	ッ	ブ 抵 抗			01
R402	RD456100	CHIP RESISTOR 1/16W	1.0K 63M J RECT.	チ	ッ	ブ 抵 抗			01
* R403	RD455330	CHIP RESISTOR 1/16W	330.0 63M J RECT.	チ	ッ	ブ 抵 抗			01
R404	RD455270	CHIP RESISTOR 1/16W	270.0 63M J RECT.	チ	ッ	ブ 抵 抗			01
R405	RD456100	CHIP RESISTOR 1/16W	1.0K 63M J RECT.	チ	ッ	ブ 抵 抗			01
R406	RD454330	CHIP RESISTOR 1/16W	33.0 63M J RECT.	チ	ッ	ブ 抵 抗			01
R408	RD454680	CHIP RESISTOR 1/16W	68.0 63M J RECT.	チ	ッ	ブ 抵 抗			01
R409	RD454330	CHIP RESISTOR 1/16W	33.0 63M J RECT.	チ	ッ	ブ 抵 抗			01
R410	RD454330	CHIP RESISTOR 1/16W	33.0 63M J RECT.	チ	ッ	ブ 抵 抗			01
R414	RF35668R	CHIP RESISTOR 1/16W	6.8K D 1608	チ	ッ	ブ 抵 抗			01
R421	RF354820	CHIP RESISTOR 1/16W	82.0 D 1608	チ	ッ	ブ 抵 抗			01
R423	RF355100	CHIP RESISTOR 1/16W	100.0 D 1608	チ	ッ	ブ 抵 抗			01
R424	RF355100	CHIP RESISTOR 1/16W	100.0 D 1608	チ	ッ	ブ 抵 抗			01
R425	RF354820	CHIP RESISTOR 1/16W	82.0 D 1608	チ	ッ	ブ 抵 抗			01
R430	RD454470	CHIP RESISTOR 1/16W	47.0 63M J RECT.	チ	ッ	ブ 抵 抗			01
R431	RD454470	CHIP RESISTOR 1/16W	47.0 63M J RECT.	チ	ッ	ブ 抵 抗			01
R433	RD45747R	CHIP RESISTOR 1/16W	47.0K 63M J RECT.	チ	ッ	ブ 抵 抗			01
R434	RD455100	CHIP RESISTOR 1/16W	100.0 63M J RECT.	チ	ッ	ブ 抵 抗			01
-436	RD455100	CHIP RESISTOR 1/16W	100.0 63M J RECT.	チ	ッ	ブ 抵 抗			01
R437	RD454750	CHIP RESISTOR 1/16W	75.0 63M J RECT.	チ	ッ	ブ 抵 抗			01
R438	RD45522R	CHIP RESISTOR 1/16W	220.0 63M J RECT.	チ	ッ	ブ 抵 抗			01
R439	RD454750	CHIP RESISTOR 1/16W	75.0 63M J RECT.	チ	ッ	ブ 抵 抗			01
R440	RD455100	CHIP RESISTOR 1/16W	100.0 63M J RECT.	チ	ッ	ブ 抵 抗			01
R441	RD454750	CHIP RESISTOR 1/16W	75.0 63M J RECT.	チ	ッ	ブ 抵 抗			01
R442	RD455100	CHIP RESISTOR 1/16W	100.0 63M J RECT.	チ	ッ	ブ 抵 抗			01
R450	RD45000R	CHIP RESISTOR 1/16W	0.00 63M J RECT.	チ	ッ	ブ 抵 抗			01
-452	RD45000R	CHIP RESISTOR 1/16W	0.00 63M J RECT.	チ	ッ	ブ 抵 抗			01
R453	RD454750	CHIP RESISTOR 1/16W	75.0 63M J RECT.	チ	ッ	ブ 抵 抗			01
-455	RD454750	CHIP RESISTOR 1/16W	75.0 63M J RECT.	チ	ッ	ブ 抵 抗			01
R456	RD456220	CHIP RESISTOR 1/16W	2.2K 63M J RECT.	チ	ッ	ブ 抵 抗			01
-458	RD456220	CHIP RESISTOR 1/16W	2.2K 63M J RECT.	チ	ッ	ブ 抵 抗			01
R459	RD454330	CHIP RESISTOR 1/16W	33.0 63M J RECT.	チ	ッ	ブ 抵 抗			01

*: New Parts

RANK: Japan only

DM

REF NO.	PART NO.	DESCRIPTION		部	品	名	REMARKS	QTY	RANK
R460	RD454330	CHIP RESISTOR 1/16W	33.0 63M J RECT.	チ	ッ	ブ	抵	抗	
R461	RD45000R	CHIP RESISTOR 1/16W	0.00 63M J RECT.	チ	ッ	ブ	抵	抗	01
R462	RD454750	CHIP RESISTOR 1/16W	75.0 63M J RECT.	チ	ッ	ブ	抵	抗	01
R463	RD455100	CHIP RESISTOR 1/16W	100.0 63M J RECT.	チ	ッ	ブ	抵	抗	
-479	RD455100	CHIP RESISTOR 1/16W	100.0 63M J RECT.	チ	ッ	ブ	抵	抗	
R500	RD454470	CHIP RESISTOR 1/16W	47.0 63M J RECT.	チ	ッ	ブ	抵	抗	01
R501	RD454330	CHIP RESISTOR 1/16W	33.0 63M J RECT.	チ	ッ	ブ	抵	抗	
R502	RD454330	CHIP RESISTOR 1/16W	33.0 63M J RECT.	チ	ッ	ブ	抵	抗	
R503	RD454680	CHIP RESISTOR 1/16W	68.0 63M J RECT.	チ	ッ	ブ	抵	抗	01
-507	RD454680	CHIP RESISTOR 1/16W	68.0 63M J RECT.	チ	ッ	ブ	抵	抗	01
R508	RD454470	CHIP RESISTOR 1/16W	47.0 63M J RECT.	チ	ッ	ブ	抵	抗	01
R509	RD456100	CHIP RESISTOR 1/16W	1.0K 63M J RECT.	チ	ッ	ブ	抵	抗	
R510	RD454680	CHIP RESISTOR 1/16W	68.0 63M J RECT.	チ	ッ	ブ	抵	抗	01
-512	RD454680	CHIP RESISTOR 1/16W	68.0 63M J RECT.	チ	ッ	ブ	抵	抗	01
R513	RD454470	CHIP RESISTOR 1/16W	47.0 63M J RECT.	チ	ッ	ブ	抵	抗	01
R514	RD454680	CHIP RESISTOR 1/16W	68.0 63M J RECT.	チ	ッ	ブ	抵	抗	01
R515	RD454680	CHIP RESISTOR 1/16W	68.0 63M J RECT.	チ	ッ	ブ	抵	抗	01
R516	RD45000R	CHIP RESISTOR 1/16W	0.00 63M J RECT.	チ	ッ	ブ	抵	抗	01
R517	RD454680	CHIP RESISTOR 1/16W	68.0 63M J RECT.	チ	ッ	ブ	抵	抗	01
R518	RD457100	CHIP RESISTOR 1/16W	10.0K 63M J RECT.	チ	ッ	ブ	抵	抗	
-522	RD457100	CHIP RESISTOR 1/16W	10.0K 63M J RECT.	チ	ッ	ブ	抵	抗	
R523	RD45000R	CHIP RESISTOR 1/16W	0.00 63M J RECT.	チ	ッ	ブ	抵	抗	01
R524	RD454220	CHIP RESISTOR 1/16W	22.0 63M J RECT.	チ	ッ	ブ	抵	抗	
R525	RD454680	CHIP RESISTOR 1/16W	68.0 63M J RECT.	チ	ッ	ブ	抵	抗	01
R526	RD454680	CHIP RESISTOR 1/16W	68.0 63M J RECT.	チ	ッ	ブ	抵	抗	01
R527	RD457100	CHIP RESISTOR 1/16W	10.0K 63M J RECT.	チ	ッ	ブ	抵	抗	
R529	RD457100	CHIP RESISTOR 1/16W	10.0K 63M J RECT.	チ	ッ	ブ	抵	抗	
R531	RD454680	CHIP RESISTOR 1/16W	68.0 63M J RECT.	チ	ッ	ブ	抵	抗	01
-536	RD454680	CHIP RESISTOR 1/16W	68.0 63M J RECT.	チ	ッ	ブ	抵	抗	01
R541	RD45000R	CHIP RESISTOR 1/16W	0.00 63M J RECT.	チ	ッ	ブ	抵	抗	01
R542	RD454470	CHIP RESISTOR 1/16W	47.0 63M J RECT.	チ	ッ	ブ	抵	抗	01
R543	RD455680	CHIP RESISTOR 1/16W	680.0 63M J RECT.	チ	ッ	ブ	抵	抗	01
R544	RD45000R	CHIP RESISTOR 1/16W	0.00 63M J RECT.	チ	ッ	ブ	抵	抗	01
R545	RD456100	CHIP RESISTOR 1/16W	1.0K 63M J RECT.	チ	ッ	ブ	抵	抗	
R546	RD454680	CHIP RESISTOR 1/16W	68.0 63M J RECT.	チ	ッ	ブ	抵	抗	01
-551	RD454680	CHIP RESISTOR 1/16W	68.0 63M J RECT.	チ	ッ	ブ	抵	抗	01
R553	RD454680	CHIP RESISTOR 1/16W	68.0 63M J RECT.	チ	ッ	ブ	抵	抗	01
-558	RD454680	CHIP RESISTOR 1/16W	68.0 63M J RECT.	チ	ッ	ブ	抵	抗	01
R559	RD457100	CHIP RESISTOR 1/16W	10.0K 63M J RECT.	チ	ッ	ブ	抵	抗	
R560	RD454680	CHIP RESISTOR 1/16W	68.0 63M J RECT.	チ	ッ	ブ	抵	抗	01
R569	RD454680	CHIP RESISTOR 1/16W	68.0 63M J RECT.	チ	ッ	ブ	抵	抗	01
R572	RD457100	CHIP RESISTOR 1/16W	10.0K 63M J RECT.	チ	ッ	ブ	抵	抗	
R573	RD456100	CHIP RESISTOR 1/16W	1.0K 63M J RECT.	チ	ッ	ブ	抵	抗	
R574	RD45522R	CHIP RESISTOR 1/16W	220.0 63M J RECT.	チ	ッ	ブ	抵	抗	01
R575	RD45000R	CHIP RESISTOR 1/16W	0.00 63M J RECT.	チ	ッ	ブ	抵	抗	01
R577	RD457100	CHIP RESISTOR 1/16W	10.0K 63M J RECT.	チ	ッ	ブ	抵	抗	
R578	RD454680	CHIP RESISTOR 1/16W	68.0 63M J RECT.	チ	ッ	ブ	抵	抗	01
R579	RD457100	CHIP RESISTOR 1/16W	10.0K 63M J RECT.	チ	ッ	ブ	抵	抗	
R580	RD454680	CHIP RESISTOR 1/16W	68.0 63M J RECT.	チ	ッ	ブ	抵	抗	01
R581	RD45000R	CHIP RESISTOR 1/16W	0.00 63M J RECT.	チ	ッ	ブ	抵	抗	01
R583	RD456100	CHIP RESISTOR 1/16W	1.0K 63M J RECT.	チ	ッ	ブ	抵	抗	
R584	RD456100	CHIP RESISTOR 1/16W	1.0K 63M J RECT.	チ	ッ	ブ	抵	抗	
R586	RD454680	CHIP RESISTOR 1/16W	68.0 63M J RECT.	チ	ッ	ブ	抵	抗	01
R587	RD457100	CHIP RESISTOR 1/16W	10.0K 63M J RECT.	チ	ッ	ブ	抵	抗	
R588	RD454680	CHIP RESISTOR 1/16W	68.0 63M J RECT.	チ	ッ	ブ	抵	抗	01
R589	RD457100	CHIP RESISTOR 1/16W	10.0K 63M J RECT.	チ	ッ	ブ	抵	抗	
R590	RD457100	CHIP RESISTOR 1/16W	10.0K 63M J RECT.	チ	ッ	ブ	抵	抗	
R607	RD454470	CHIP RESISTOR 1/16W	47.0 63M J RECT.	チ	ッ	ブ	抵	抗	01
R608	RD454470	CHIP RESISTOR 1/16W	47.0 63M J RECT.	チ	ッ	ブ	抵	抗	01
R620	RD455100	CHIP RESISTOR 1/16W	100.0 63M J RECT.	チ	ッ	ブ	抵	抗	
-625	RD455100	CHIP RESISTOR 1/16W	100.0 63M J RECT.	チ	ッ	ブ	抵	抗	
R626	RD457100	CHIP RESISTOR 1/16W	10.0K 63M J RECT.	チ	ッ	ブ	抵	抗	
R627	RD456100	CHIP RESISTOR 1/16W	1.0K 63M J RECT.	チ	ッ	ブ	抵	抗	
R628	RD454680	CHIP RESISTOR 1/16W	68.0 63M J RECT.	チ	ッ	ブ	抵	抗	01
R629	RD454680	CHIP RESISTOR 1/16W	68.0 63M J RECT.	チ	ッ	ブ	抵	抗	01
R646	RD45000R	CHIP RESISTOR 1/16W	0.00 63M J RECT.	チ	ッ	ブ	抵	抗	01
R647	RD45000R	CHIP RESISTOR 1/16W	0.00 63M J RECT.	チ	ッ	ブ	抵	抗	01
R648	RD454390	CHIP RESISTOR 1/16W	39.0 63M J RECT.	チ	ッ	ブ	抵	抗	01
-650	RD454390	CHIP RESISTOR 1/16W	39.0 63M J RECT.	チ	ッ	ブ	抵	抗	01
R651	RD455100	CHIP RESISTOR 1/16W	100.0 63M J RECT.	チ	ッ	ブ	抵	抗	

*: New Parts

RANK: Japan only

DM

REF NO.	PART NO.	DESCRIPTION		部	品	名	REMARKS	QTY	RANK
R652	RD454390	CHIP RESISTOR 1/16W	39.0 63M J RECT.	チ	ッ	ブ 抵 抗			01
R653	RD45000R	CHIP RESISTOR 1/16W	0.00 63M J RECT.	チ	ッ	ブ 抵 抗			01
R654	RD45000R	CHIP RESISTOR 1/16W	0.00 63M J RECT.	チ	ッ	ブ 抵 抗			01
R655	RD454390	CHIP RESISTOR 1/16W	39.0 63M J RECT.	チ	ッ	ブ 抵 抗			01
-657	RD454390	CHIP RESISTOR 1/16W	39.0 63M J RECT.	チ	ッ	ブ 抵 抗			01
R658	RD454470	CHIP RESISTOR 1/16W	47.0 63M J RECT.	チ	ッ	ブ 抵 抗			01
R663	RD454680	CHIP RESISTOR 1/16W	68.0 63M J RECT.	チ	ッ	ブ 抵 抗			01
-667	RD454680	CHIP RESISTOR 1/16W	68.0 63M J RECT.	チ	ッ	ブ 抵 抗			01
R669	RD454680	CHIP RESISTOR 1/16W	68.0 63M J RECT.	チ	ッ	ブ 抵 抗			01
-671	RD454680	CHIP RESISTOR 1/16W	68.0 63M J RECT.	チ	ッ	ブ 抵 抗			01
R672	RD45000R	CHIP RESISTOR 1/16W	0.00 63M J RECT.	チ	ッ	ブ 抵 抗			01
R673	RD45000R	CHIP RESISTOR 1/16W	0.00 63M J RECT.	チ	ッ	ブ 抵 抗			01
R674	RD454680	CHIP RESISTOR 1/16W	68.0 63M J RECT.	チ	ッ	ブ 抵 抗			01
R675	RD45000R	CHIP RESISTOR 1/16W	0.00 63M J RECT.	チ	ッ	ブ 抵 抗			01
R676	RD45000R	CHIP RESISTOR 1/16W	0.00 63M J RECT.	チ	ッ	ブ 抵 抗			01
R677	RD454390	CHIP RESISTOR 1/16W	39.0 63M J RECT.	チ	ッ	ブ 抵 抗			01
-679	RD454390	CHIP RESISTOR 1/16W	39.0 63M J RECT.	チ	ッ	ブ 抵 抗			01
R680	RD455100	CHIP RESISTOR 1/16W	100.0 63M J RECT.	チ	ッ	ブ 抵 抗			01
R681	RD454390	CHIP RESISTOR 1/16W	39.0 63M J RECT.	チ	ッ	ブ 抵 抗			01
R682	RD45000R	CHIP RESISTOR 1/16W	0.00 63M J RECT.	チ	ッ	ブ 抵 抗			01
R683	RD45000R	CHIP RESISTOR 1/16W	0.00 63M J RECT.	チ	ッ	ブ 抵 抗			01
R684	RD454390	CHIP RESISTOR 1/16W	39.0 63M J RECT.	チ	ッ	ブ 抵 抗			01
-686	RD454390	CHIP RESISTOR 1/16W	39.0 63M J RECT.	チ	ッ	ブ 抵 抗			01
R687	RD454680	CHIP RESISTOR 1/16W	68.0 63M J RECT.	チ	ッ	ブ 抵 抗			01
R688	RD454680	CHIP RESISTOR 1/16W	68.0 63M J RECT.	チ	ッ	ブ 抵 抗			01
R690	RD454680	CHIP RESISTOR 1/16W	68.0 63M J RECT.	チ	ッ	ブ 抵 抗			01
-694	RD454680	CHIP RESISTOR 1/16W	68.0 63M J RECT.	チ	ッ	ブ 抵 抗			01
R696	RD454680	CHIP RESISTOR 1/16W	68.0 63M J RECT.	チ	ッ	ブ 抵 抗			01
-698	RD454680	CHIP RESISTOR 1/16W	68.0 63M J RECT.	チ	ッ	ブ 抵 抗			01
R699	RD454390	CHIP RESISTOR 1/16W	39.0 63M J RECT.	チ	ッ	ブ 抵 抗			01
-720	RD454390	CHIP RESISTOR 1/16W	39.0 63M J RECT.	チ	ッ	ブ 抵 抗			01
R721	RD454560	CHIP RESISTOR 1/16W	56.0 63M J RECT.	チ	ッ	ブ 抵 抗			01
R722	RD454390	CHIP RESISTOR 1/16W	39.0 63M J RECT.	チ	ッ	ブ 抵 抗			01
-728	RD454390	CHIP RESISTOR 1/16W	39.0 63M J RECT.	チ	ッ	ブ 抵 抗			01
R729	RD454680	CHIP RESISTOR 1/16W	68.0 63M J RECT.	チ	ッ	ブ 抵 抗			01
R730	RD454390	CHIP RESISTOR 1/16W	39.0 63M J RECT.	チ	ッ	ブ 抵 抗			01
R731	RD454680	CHIP RESISTOR 1/16W	68.0 63M J RECT.	チ	ッ	ブ 抵 抗			01
-754	RD454680	CHIP RESISTOR 1/16W	68.0 63M J RECT.	チ	ッ	ブ 抵 抗			01
R755	RD454390	CHIP RESISTOR 1/16W	39.0 63M J RECT.	チ	ッ	ブ 抵 抗			01
-766	RD454390	CHIP RESISTOR 1/16W	39.0 63M J RECT.	チ	ッ	ブ 抵 抗			01
R767	RD454680	CHIP RESISTOR 1/16W	68.0 63M J RECT.	チ	ッ	ブ 抵 抗			01
-770	RD454680	CHIP RESISTOR 1/16W	68.0 63M J RECT.	チ	ッ	ブ 抵 抗			01
R771	RD45000R	CHIP RESISTOR 1/16W	0.00 63M J RECT.	チ	ッ	ブ 抵 抗			01
R808	RD457100	CHIP RESISTOR 1/16W	10.0K 63M J RECT.	チ	ッ	ブ 抵 抗			01
R809	RD454470	CHIP RESISTOR 1/16W	47.0 63M J RECT.	チ	ッ	ブ 抵 抗			01
R810	RD457100	CHIP RESISTOR 1/16W	10.0K 63M J RECT.	チ	ッ	ブ 抵 抗			01
-813	RD457100	CHIP RESISTOR 1/16W	10.0K 63M J RECT.	チ	ッ	ブ 抵 抗			01
R814	RD454470	CHIP RESISTOR 1/16W	47.0 63M J RECT.	チ	ッ	ブ 抵 抗			01
R815	RD454470	CHIP RESISTOR 1/16W	47.0 63M J RECT.	チ	ッ	ブ 抵 抗			01
R816	RD457100	CHIP RESISTOR 1/16W	10.0K 63M J RECT.	チ	ッ	ブ 抵 抗			01
R833	RD457100	CHIP RESISTOR 1/16W	10.0K 63M J RECT.	チ	ッ	ブ 抵 抗			01
R834	RD454470	CHIP RESISTOR 1/16W	47.0 63M J RECT.	チ	ッ	ブ 抵 抗			01
R835	RD457100	CHIP RESISTOR 1/16W	10.0K 63M J RECT.	チ	ッ	ブ 抵 抗			01
-837	RD457100	CHIP RESISTOR 1/16W	10.0K 63M J RECT.	チ	ッ	ブ 抵 抗			01
R838	RD454470	CHIP RESISTOR 1/16W	47.0 63M J RECT.	チ	ッ	ブ 抵 抗			01
R839	RD454470	CHIP RESISTOR 1/16W	47.0 63M J RECT.	チ	ッ	ブ 抵 抗			01
R840	RD457100	CHIP RESISTOR 1/16W	10.0K 63M J RECT.	チ	ッ	ブ 抵 抗			01
R851	RD454680	CHIP RESISTOR 1/16W	68.0 63M J RECT.	チ	ッ	ブ 抵 抗			01
R852	RD454680	CHIP RESISTOR 1/16W	68.0 63M J RECT.	チ	ッ	ブ 抵 抗			01
R853	RD454470	CHIP RESISTOR 1/16W	47.0 63M J RECT.	チ	ッ	ブ 抵 抗			01
-888	RD454470	CHIP RESISTOR 1/16W	47.0 63M J RECT.	チ	ッ	ブ 抵 抗			01
R889	RD454390	CHIP RESISTOR 1/16W	39.0 63M J RECT.	チ	ッ	ブ 抵 抗	※ 1		01
-899	RD454390	CHIP RESISTOR 1/16W	39.0 63M J RECT.	チ	ッ	ブ 抵 抗	※ 1		01
R900	RD45000R	CHIP RESISTOR 1/16W	0.00 63M J RECT.	チ	ッ	ブ 抵 抗			01
-904	RD45000R	CHIP RESISTOR 1/16W	0.00 63M J RECT.	チ	ッ	ブ 抵 抗			01
R907	RD45000R	CHIP RESISTOR 1/16W	0.00 63M J RECT.	チ	ッ	ブ 抵 抗			01
R908	RD454680	CHIP RESISTOR 1/16W	68.0 63M J RECT.	チ	ッ	ブ 抵 抗			01
R909	RD45522R	CHIP RESISTOR 1/16W	220.0 63M J RECT.	チ	ッ	ブ 抵 抗			01
R910	RD45522R	CHIP RESISTOR 1/16W	220.0 63M J RECT.	チ	ッ	ブ 抵 抗			01
R911	RD456390	CHIP RESISTOR 1/16W	3.9K 63M J RECT.	チ	ッ	ブ 抵 抗			01

*: New Parts

RANK: Japan only

DM

REF NO.	PART NO.	DESCRIPTION		部	品	名	REMARKS	QTY	RANK
-918	RD456390	CHIP RESISTOR 1/16W	3.9K 63M J RECT.	チ	ッ	ブ 抵 抗			
R919	RD457120	CHIP RESISTOR 1/16W	12.0K 63M J RECT.	チ	ッ	ブ 抵 抗			
-923	RD457120	CHIP RESISTOR 1/16W	12.0K 63M J RECT.	チ	ッ	ブ 抵 抗			
R924	RD456470	CHIP RESISTOR 1/16W	4.7K 63M J RECT.	チ	ッ	ブ 抵 抗			
R925	RD456470	CHIP RESISTOR 1/16W	4.7K 63M J RECT.	チ	ッ	ブ 抵 抗			
R926	RD457120	CHIP RESISTOR 1/16W	12.0K 63M J RECT.	チ	ッ	ブ 抵 抗			
R927	RD456470	CHIP RESISTOR 1/16W	4.7K 63M J RECT.	チ	ッ	ブ 抵 抗			
R928	RD456470	CHIP RESISTOR 1/16W	4.7K 63M J RECT.	チ	ッ	ブ 抵 抗			
R929	RD457120	CHIP RESISTOR 1/16W	12.0K 63M J RECT.	チ	ッ	ブ 抵 抗			
R930	RD456470	CHIP RESISTOR 1/16W	4.7K 63M J RECT.	チ	ッ	ブ 抵 抗			
R931	RD456470	CHIP RESISTOR 1/16W	4.7K 63M J RECT.	チ	ッ	ブ 抵 抗			
R932	RD457120	CHIP RESISTOR 1/16W	12.0K 63M J RECT.	チ	ッ	ブ 抵 抗			
R933	RD456470	CHIP RESISTOR 1/16W	4.7K 63M J RECT.	チ	ッ	ブ 抵 抗			
R934	RD456470	CHIP RESISTOR 1/16W	4.7K 63M J RECT.	チ	ッ	ブ 抵 抗			
R938	RD45000R	CHIP RESISTOR 1/16W	0.00 63M J RECT.	チ	ッ	ブ 抵 抗			01
-941	RD45000R	CHIP RESISTOR 1/16W	0.00 63M J RECT.	チ	ッ	ブ 抵 抗			01
R942	RD457330	CHIP RESISTOR 1/16W	33.0K 63M J RECT.	チ	ッ	ブ 抵 抗			01
R943	RD457330	CHIP RESISTOR 1/16W	33.0K 63M J RECT.	チ	ッ	ブ 抵 抗			01
R944	RD454470	CHIP RESISTOR 1/16W	47.0 63M J RECT.	チ	ッ	ブ 抵 抗			01
-947	RD454470	CHIP RESISTOR 1/16W	47.0 63M J RECT.	チ	ッ	ブ 抵 抗			01
* R948	RD457820	CHIP RESISTOR 1/16W	82.0K 63M J RECT.	チ	ッ	ブ 抵 抗			
* R949	RD457820	CHIP RESISTOR 1/16W	82.0K 63M J RECT.	チ	ッ	ブ 抵 抗			
R950	RD458100	CHIP RESISTOR 1/16W	100.0K 63M J RECT.	チ	ッ	ブ 抵 抗			
R951	RD458100	CHIP RESISTOR 1/16W	100.0K 63M J RECT.	チ	ッ	ブ 抵 抗			
R952	RD456220	CHIP RESISTOR 1/16W	2.2K 63M J RECT.	チ	ッ	ブ 抵 抗			
R953	RD456220	CHIP RESISTOR 1/16W	2.2K 63M J RECT.	チ	ッ	ブ 抵 抗			
R954	RD456100	CHIP RESISTOR 1/16W	1.0K 63M J RECT.	チ	ッ	ブ 抵 抗			
R955	RD456100	CHIP RESISTOR 1/16W	1.0K 63M J RECT.	チ	ッ	ブ 抵 抗			
R956	RD458100	CHIP RESISTOR 1/16W	100.0K 63M J RECT.	チ	ッ	ブ 抵 抗			
R957	RD458100	CHIP RESISTOR 1/16W	100.0K 63M J RECT.	チ	ッ	ブ 抵 抗			
R960	RD45000R	CHIP RESISTOR 1/16W	0.00 63M J RECT.	チ	ッ	ブ 抵 抗			01
R961	RD45000R	CHIP RESISTOR 1/16W	0.00 63M J RECT.	チ	ッ	ブ 抵 抗			01
R962	WD07550R	CARBON RESISTOR (CHIP)	6.8 1/8W J	チ	ッ	ブ 抵 抗			
-965	WD07550R	CARBON RESISTOR (CHIP)	6.8 1/8W J	チ	ッ	ブ 抵 抗			
R970	RD457100	CHIP RESISTOR 1/16W	10.0K 63M J RECT.	チ	ッ	ブ 抵 抗			
-972	RD457100	CHIP RESISTOR 1/16W	10.0K 63M J RECT.	チ	ッ	ブ 抵 抗			
R973	RD456100	CHIP RESISTOR 1/16W	1.0K 63M J RECT.	チ	ッ	ブ 抵 抗			
R974	RD45000R	CHIP RESISTOR 1/16W	0.00 63M J RECT.	チ	ッ	ブ 抵 抗			01
R975	RD45000R	CHIP RESISTOR 1/16W	0.00 63M J RECT.	チ	ッ	ブ 抵 抗			01
R1000	RD454390	CHIP RESISTOR 1/16W	39.0 63M J RECT.	チ	ッ	ブ 抵 抗		※1	01
-1008	RD454390	CHIP RESISTOR 1/16W	39.0 63M J RECT.	チ	ッ	ブ 抵 抗		※1	01
R1100	RD350001	CHIP RESISTOR 1/16W	0 63M J RECT.	チ	ッ	ブ 抵 抗			01
-1110	RD350001	CHIP RESISTOR 1/16W	0 63M J RECT.	チ	ッ	ブ 抵 抗			01
RA1	WH205400	RESISTOR ARRAY	22 X 4	抵	抗	ア レ イ			01
-8	WH205400	RESISTOR ARRAY	22 X 4	抵	抗	ア レ イ			01
RA9	WH206600	RESISTOR ARRAY	68 X 4	抵	抗	ア レ イ			01
RA10	WH206600	RESISTOR ARRAY	68 X 4	抵	抗	ア レ イ			01
RA11	WH213400	RESISTOR ARRAY	47K X 4	抵	抗	ア レ イ			01
RA12	WH206600	RESISTOR ARRAY	68 X 4	抵	抗	ア レ イ			01
RA13	WH213400	RESISTOR ARRAY	47K X 4	抵	抗	ア レ イ			01
RA15	WH213400	RESISTOR ARRAY	47K X 4	抵	抗	ア レ イ			01
RA16	WH216700	RESISTOR ARRAY	0 X 4	抵	抗	ア レ イ			01
RA17	WH206600	RESISTOR ARRAY	68 X 4	抵	抗	ア レ イ			01
-24	WH206600	RESISTOR ARRAY	68 X 4	抵	抗	ア レ イ			01
RA25	WH206200	RESISTOR ARRAY	47 X 4	抵	抗	ア レ イ			01
-32	WH206200	RESISTOR ARRAY	47 X 4	抵	抗	ア レ イ			01
RA33	WH206600	RESISTOR ARRAY	68 X 4	抵	抗	ア レ イ			01
-36	WH206600	RESISTOR ARRAY	68 X 4	抵	抗	ア レ イ			01
RA37	WH206200	RESISTOR ARRAY	47 X 4	抵	抗	ア レ イ			01
-44	WH206200	RESISTOR ARRAY	47 X 4	抵	抗	ア レ イ			01
RA45	WH207000	RESISTOR ARRAY	100 X 4	抵	抗	ア レ イ			
-50	WH207000	RESISTOR ARRAY	100 X 4	抵	抗	ア レ イ			
RA51	WH206200	RESISTOR ARRAY	47 X 4	抵	抗	ア レ イ			01
RA52	WH206200	RESISTOR ARRAY	47 X 4	抵	抗	ア レ イ			01
* RA53	WH204600	RESISTOR ARRAY	10 X 4	抵	抗	ア レ イ			
* -58	WH204600	RESISTOR ARRAY	10 X 4	抵	抗	ア レ イ			
RA65	WH213400	RESISTOR ARRAY	47K X 4	抵	抗	ア レ イ			01
-68	WH213400	RESISTOR ARRAY	47K X 4	抵	抗	ア レ イ			01
* RA69	WH204600	RESISTOR ARRAY	10 X 4	抵	抗	ア レ イ			
* -72	WH204600	RESISTOR ARRAY	10 X 4	抵	抗	ア レ イ			

*: New Parts

RANK: Japan only

DM

REF NO.	PART NO.	DESCRIPTION	部	品	名	REMARKS	QTY	RANK	
RA73	WH206200	RESISTOR ARRAY	47 X 4	抵	抗	ア	レ	イ	01
-76	WH206200	RESISTOR ARRAY	47 X 4	抵	抗	ア	レ	イ	01
* RA200	WH210600	RESISTOR ARRAY	3.3K X 4	抵	抗	ア	レ	イ	
RA201	WH205400	RESISTOR ARRAY	22 X 4	抵	抗	ア	レ	イ	01
-205	WH205400	RESISTOR ARRAY	22 X 4	抵	抗	ア	レ	イ	01
RA206	WH216700	RESISTOR ARRAY	0 X 4	抵	抗	ア	レ	イ	01
RA207	WH216700	RESISTOR ARRAY	0 X 4	抵	抗	ア	レ	イ	01
RA208	WH206200	RESISTOR ARRAY	47 X 4	抵	抗	ア	レ	イ	01
-215	WH206200	RESISTOR ARRAY	47 X 4	抵	抗	ア	レ	イ	01
RA216	WH206600	RESISTOR ARRAY	68 X 4	抵	抗	ア	レ	イ	01
-219	WH206600	RESISTOR ARRAY	68 X 4	抵	抗	ア	レ	イ	01
RA220	WH213400	RESISTOR ARRAY	47K X 4	抵	抗	ア	レ	イ	01
-223	WH213400	RESISTOR ARRAY	47K X 4	抵	抗	ア	レ	イ	01
RA224	WH205400	RESISTOR ARRAY	22 X 4	抵	抗	ア	レ	イ	01
RA225	WH205400	RESISTOR ARRAY	22 X 4	抵	抗	ア	レ	イ	01
RA226	WH206200	RESISTOR ARRAY	47 X 4	抵	抗	ア	レ	イ	01
-234	WH206200	RESISTOR ARRAY	47 X 4	抵	抗	ア	レ	イ	01
RA400	WH216700	RESISTOR ARRAY	0 X 4	抵	抗	ア	レ	イ	01
-405	WH216700	RESISTOR ARRAY	0 X 4	抵	抗	ア	レ	イ	01
RA406	WH206200	RESISTOR ARRAY	47 X 4	抵	抗	ア	レ	イ	01
-409	WH206200	RESISTOR ARRAY	47 X 4	抵	抗	ア	レ	イ	01
RA410	WH213400	RESISTOR ARRAY	47K X 4	抵	抗	ア	レ	イ	01
-414	WH213400	RESISTOR ARRAY	47K X 4	抵	抗	ア	レ	イ	01
RA500	WH205400	RESISTOR ARRAY	22 X 4	抵	抗	ア	レ	イ	01
-503	WH205400	RESISTOR ARRAY	22 X 4	抵	抗	ア	レ	イ	01
RA504	WH206200	RESISTOR ARRAY	47 X 4	抵	抗	ア	レ	イ	01
-511	WH206200	RESISTOR ARRAY	47 X 4	抵	抗	ア	レ	イ	01
RA512	WH211800	RESISTOR ARRAY	10K X 4	抵	抗	ア	レ	イ	
RA513	WH211800	RESISTOR ARRAY	10K X 4	抵	抗	ア	レ	イ	01
RA514	WH214200	RESISTOR ARRAY	100K X 4	抵	抗	ア	レ	イ	01
RA515	WH206600	RESISTOR ARRAY	68 X 4	抵	抗	ア	レ	イ	01
RA516	WH206600	RESISTOR ARRAY	68 X 4	抵	抗	ア	レ	イ	01
RA517	WH214200	RESISTOR ARRAY	100K X 4	抵	抗	ア	レ	イ	01
RA518	WH206600	RESISTOR ARRAY	68 X 4	抵	抗	ア	レ	イ	01
RA519	WH206600	RESISTOR ARRAY	68 X 4	抵	抗	ア	レ	イ	01
RA520	WH214200	RESISTOR ARRAY	100K X 4	抵	抗	ア	レ	イ	01
RA521	WH206600	RESISTOR ARRAY	68 X 4	抵	抗	ア	レ	イ	01
RA522	WH206600	RESISTOR ARRAY	68 X 4	抵	抗	ア	レ	イ	01
RA523	WH214200	RESISTOR ARRAY	100K X 4	抵	抗	ア	レ	イ	01
RA524	WH206600	RESISTOR ARRAY	68 X 4	抵	抗	ア	レ	イ	01
RA525	WH206600	RESISTOR ARRAY	68 X 4	抵	抗	ア	レ	イ	01
RA526	WH214200	RESISTOR ARRAY	100K X 4	抵	抗	ア	レ	イ	01
RA527	WH206600	RESISTOR ARRAY	68 X 4	抵	抗	ア	レ	イ	01
RA528	WH206600	RESISTOR ARRAY	68 X 4	抵	抗	ア	レ	イ	01
RA529	WH211800	RESISTOR ARRAY	10K X 4	抵	抗	ア	レ	イ	01
RA530	WH206200	RESISTOR ARRAY	47 X 4	抵	抗	ア	レ	イ	01
-545	WH206200	RESISTOR ARRAY	47 X 4	抵	抗	ア	レ	イ	01
RA546	WH211800	RESISTOR ARRAY	10K X 4	抵	抗	ア	レ	イ	
-548	WH211800	RESISTOR ARRAY	10K X 4	抵	抗	ア	レ	イ	01
RA549	WH205400	RESISTOR ARRAY	22 X 4	抵	抗	ア	レ	イ	01
-556	WH205400	RESISTOR ARRAY	22 X 4	抵	抗	ア	レ	イ	01
RA557	WH206600	RESISTOR ARRAY	68 X 4	抵	抗	ア	レ	イ	01
RA558	WH206000	RESISTOR ARRAY	39 X 4	抵	抗	ア	レ	イ	01
-565	WH206000	RESISTOR ARRAY	39 X 4	抵	抗	ア	レ	イ	01
RA566	WH206600	RESISTOR ARRAY	68 X 4	抵	抗	ア	レ	イ	01
-568	WH206600	RESISTOR ARRAY	68 X 4	抵	抗	ア	レ	イ	01
RA569	WH206200	RESISTOR ARRAY	47 X 4	抵	抗	ア	レ	イ	01
RA570	WH206200	RESISTOR ARRAY	47 X 4	抵	抗	ア	レ	イ	01
RA571	WH206600	RESISTOR ARRAY	68 X 4	抵	抗	ア	レ	イ	01
RA572	WH206600	RESISTOR ARRAY	68 X 4	抵	抗	ア	レ	イ	01
RA573	WH205400	RESISTOR ARRAY	22 X 4	抵	抗	ア	レ	イ	01
-576	WH205400	RESISTOR ARRAY	22 X 4	抵	抗	ア	レ	イ	01
RA579	WH205400	RESISTOR ARRAY	22 X 4	抵	抗	ア	レ	イ	01
-582	WH205400	RESISTOR ARRAY	22 X 4	抵	抗	ア	レ	イ	01
RA585	WH205400	RESISTOR ARRAY	22 X 4	抵	抗	ア	レ	イ	01
-590	WH205400	RESISTOR ARRAY	22 X 4	抵	抗	ア	レ	イ	01
RA591	WH206200	RESISTOR ARRAY	47 X 4	抵	抗	ア	レ	イ	01
RA592	WH206200	RESISTOR ARRAY	47 X 4	抵	抗	ア	レ	イ	01
RA593	WH206600	RESISTOR ARRAY	68 X 4	抵	抗	ア	レ	イ	01
RA594	WH206600	RESISTOR ARRAY	68 X 4	抵	抗	ア	レ	イ	01

*: New Parts

RANK: Japan only

DM and EN/PNC

REF NO.	PART NO.	DESCRIPTION		部 品 名	REMARKS	QTY	RANK
RA595	WH205400	RESISTOR ARRAY	22 X 4	抵 抗 ア レ イ			01
RA596	WH205400	RESISTOR ARRAY	22 X 4	抵 抗 ア レ イ			01
RA597	WH206600	RESISTOR ARRAY	68 X 4	抵 抗 ア レ イ			01
-600	WH206600	RESISTOR ARRAY	68 X 4	抵 抗 ア レ イ			01
RA601	WH205400	RESISTOR ARRAY	22 X 4	抵 抗 ア レ イ			01
-604	WH205400	RESISTOR ARRAY	22 X 4	抵 抗 ア レ イ			01
RA607	WH205400	RESISTOR ARRAY	22 X 4	抵 抗 ア レ イ			01
-610	WH205400	RESISTOR ARRAY	22 X 4	抵 抗 ア レ イ			01
RA613	WH216700	RESISTOR ARRAY	0 X 4	抵 抗 ア レ イ			01
-616	WH216700	RESISTOR ARRAY	0 X 4	抵 抗 ア レ イ			01
RA617	WH205400	RESISTOR ARRAY	22 X 4	抵 抗 ア レ イ			01
-632	WH205400	RESISTOR ARRAY	22 X 4	抵 抗 ア レ イ			01
RA633	WH206200	RESISTOR ARRAY	47 X 4	抵 抗 ア レ イ			01
-640	WH206200	RESISTOR ARRAY	47 X 4	抵 抗 ア レ イ			01
RA641	WH206000	RESISTOR ARRAY	39 X 4	抵 抗 ア レ イ			01
-664	WH206000	RESISTOR ARRAY	39 X 4	抵 抗 ア レ イ			01
RA800	WH205400	RESISTOR ARRAY	22 X 4	抵 抗 ア レ イ			01
-807	WH205400	RESISTOR ARRAY	22 X 4	抵 抗 ア レ イ			01
RA808	WH206200	RESISTOR ARRAY	47 X 4	抵 抗 ア レ イ			01
-815	WH206200	RESISTOR ARRAY	47 X 4	抵 抗 ア レ イ			01
RA816	WH206000	RESISTOR ARRAY	39 X 4	抵 抗 ア レ イ			01
-823	WH206000	RESISTOR ARRAY	39 X 4	抵 抗 ア レ イ			01
RA824	WH206000	RESISTOR ARRAY	39 X 4	抵 抗 ア レ イ	※1		01
-843	WH206000	RESISTOR ARRAY	39 X 4	抵 抗 ア レ イ	※1		01
TA400	V273190R	PAIR TRANSISTOR	IMX9	ベ ア ト ラ ン ジ ス タ			01
TR900	VV556400	TRANSISTOR	2SC2412K Q,R,S TP	ト ラ ン ジ ス タ 2 S C			
TR900	WC52940R	TRANSISTOR	KTC3875S-Y	ト ラ ン ジ ス タ			01
* X1	WM284600	QUARTZ CRYSTAL UNIT	24.000MHz DSO321SR	水 晶 発 振 器			
* X4	WP142100	QUARTZ CRYSTAL UNIT	16.000MHz DSO321SR	水 晶 発 振 器			
* X200	WM284900	QUARTZ CRYSTAL UNIT	22.5792MHz DSX321G	水 晶 振 動 子			
X201	WK192600	QUARTZ CRYSTAL UNIT	12MHz DSX321G	水 晶 振 動 子			
X202	WM135400	QUARTZ CRISTAL UNIT	25MHz DSX321G	水 晶 振 動 子			
* X400	WM285100	QUARTZ CRYSTAL UNIT	17.734475MHz DSX321G	水 晶 振 動 子			
* X401	WM285000	QUARTZ CRYSTAL UNIT	14.31818MHz DSX321G	水 晶 振 動 子			
* X402	WM284700	QUARTZ CRYSTAL UNIT	25.175MHz DSO321SR	水 晶 発 振 器			
* X500	WM284800	QUARTZ CRYSTAL UNIT	16.666666MHz DSX321G	水 晶 振 動 子			
* C22	WK611800	CIRCUIT BOARD	EN	E N シ ー ト	(WM24260)(X9411B0)		
* C22	WK611400	CIRCUIT BOARD	PNC	P N C シ ー ト	(WM24260)(X9411B0)		
C23	US14510R	CERAMIC CAPACITOR-F (CHIP)	0.1000 25V Z RECT.	チ ッ プ セ ラ (F)			01
CN1	VB39000R	CERAMIC CAPACITOR-F (CHIP)	0.1000 25V Z RECT.	チ ッ プ セ ラ (F)			01
CN2	WK743400	CONNECTOR	PH 4P TE	ベ ー ス ポ ス ト			
CN201	WK743400	FFC CONNECTOR	52807 22P SE	F F C コ ネ ク タ			
D1	VB858300	BASE-PIN	PH 4P SE	ベ ー ス ポ ス ト			
-33	WG139300	DIODE	KDS4148U-RTK/P TE	ダ イ オ ー ド			
D201	WG139300	DIODE	KDS4148U-RTK/P TE	ダ イ オ ー ド			
D202	WG139300	DIODE	KDS4148U-RTK/P TE	ダ イ オ ー ド			
EC201	VU48130R	ENCODER	REB161(9X5)PVB15FH	1 6 形 エ ン コ ー ダ	DATA ENTRY		03
R1	RD350001	CHIP RESISTOR 1/16W	0 63M J RECT.	チ ッ プ 抵 抗			01
-3	RD350001	CHIP RESISTOR 1/16W	0 63M J RECT.	チ ッ プ 抵 抗			01
R22	RD15510R	CARBON RESISTOR (CHIP)	100.0 1/4 J TP	チ ッ プ 抵 抗			01
-29	RD15510R	CARBON RESISTOR (CHIP)	100.0 1/4 J TP	チ ッ プ 抵 抗			01
R30	RD350001	CHIP RESISTOR 1/16W	0 63M J RECT.	チ ッ プ 抵 抗			01
SW1	WG31840R	TACT SWITCH	SKRGAMD010	タ ク ト S W	[1] (up)		01
SW2	WG31840R	TACT SWITCH	SKRGAMD010	タ ク ト S W	[1] (down)		01
SW3	WG31840R	TACT SWITCH	SKRGAMD010	タ ク ト S W	[5] (up)		01
SW4	WG31840R	TACT SWITCH	SKRGAMD010	タ ク ト S W	[5] (down)		01
SW5	WG31840R	TACT SWITCH	SKRGAMD010	タ ク ト S W	[2] (up)		01
SW6	WG31840R	TACT SWITCH	SKRGAMD010	タ ク ト S W	[2] (down)		01
SW7	WG31840R	TACT SWITCH	SKRGAMD010	タ ク ト S W	[6] (up)		01
SW8	WG31840R	TACT SWITCH	SKRGAMD010	タ ク ト S W	[6] (down)		01
SW9	WG31840R	TACT SWITCH	SKRGAMD010	タ ク ト S W	[3] (up)		01
SW10	WG31840R	TACT SWITCH	SKRGAMD010	タ ク ト S W	[3] (down)		01
SW11	WG31840R	TACT SWITCH	SKRGAMD010	タ ク ト S W	[7] (up)		01
SW12	WG31840R	TACT SWITCH	SKRGAMD010	タ ク ト S W	[7] (down)		01
SW13	WG31840R	TACT SWITCH	SKRGAMD010	タ ク ト S W	[4] (up)		01
SW14	WG31840R	TACT SWITCH	SKRGAMD010	タ ク ト S W	[4] (down)		01
SW15	WG31840R	TACT SWITCH	SKRGAMD010	タ ク ト S W	[8] (up)		01
SW16	WG31840R	TACT SWITCH	SKRGAMD010	タ ク ト S W	[8] (down)		01

*: New Parts

RANK: Japan only

EN/PNC and HDSB and LCL/LCR

REF NO.	PART NO.	DESCRIPTION		部 品 名	REMARKS	QTY	RANK
SW17	WG31840R	TACT SWITCH	SKRGAMD010	タ ク ト S W	ENTER		01
* VR1	WN562700	SLIDE VARIABLE RESISTOR	B 10.0K RS20111A9A	ス ラ イ ド V R	[1] slider		
* VR2	WN562700	SLIDE VARIABLE RESISTOR	B 10.0K RS20111A9A	ス ラ イ ド V R	[2] slider		
* VR3	WN562700	SLIDE VARIABLE RESISTOR	B 10.0K RS20111A9A	ス ラ イ ド V R	[3] slider		
* VR4	WN562700	SLIDE VARIABLE RESISTOR	B 10.0K RS20111A9A	ス ラ イ ド V R	[4] slider		
* VR5	WN562700	SLIDE VARIABLE RESISTOR	B 10.0K RS20111A9A	ス ラ イ ド V R	[5] slider		
* VR6	WN562700	SLIDE VARIABLE RESISTOR	B 10.0K RS20111A9A	ス ラ イ ド V R	[6] slider		
* VR7	WN562700	SLIDE VARIABLE RESISTOR	B 10.0K RS20111A9A	ス ラ イ ド V R	[7] slider		
* VR8	WN562700	SLIDE VARIABLE RESISTOR	B 10.0K RS20111A9A	ス ラ イ ド V R	[8] slider		
* C4	WM840900	CIRCUIT BOARD	HDSB	H D S B シ ー ト	(WM82880)(X6800B0)		
C5	WA45810R	ELECTROLYTIC CAPACITOR	1000 25.0V TP	ケ ミ コ ン P W			01
C6	VC69480R	CEAMIC CAPACITOR	0.1000 25V Z TATET	半 導 体 セ ラ コ ン			01
C7	FG64410R	CERAMIC CAPACITOR-F	0.0100 50V Z RX TP	セ ラ コ ン (F)			01
C8	VC69480R	CEAMIC CAPACITOR	0.1000 25V Z TATET	半 導 体 セ ラ コ ン			01
C9	WA45810R	ELECTROLYTIC CAPACITOR	1000 25.0V TP	ケ ミ コ ン P W			01
C10	VC69480R	CEAMIC CAPACITOR	0.1000 25V Z TATET	半 導 体 セ ラ コ ン			01
CN1	WA45810R	ELECTROLYTIC CAPACITOR	1000 25.0V TP	ケ ミ コ ン P W			01
CN2	LB918020	BASE PIN	XH 2P TE I-TYPE	ベ ー ス ツ キ ポ ス ト			0
CN4	VB39000R	CONNECTOR	PH 4P TE	ベ ー ス ツ キ ポ ス ト			0
CN5	WE69380R	PIN HEADER SIDE	2mm GSF203 44P SE	ピ ン ヘ ッ ダ ー 2 m m			04
D95	WB497000	FCC CONNECTOR	FFC FMN 40P TE	F F C コ ネ ク タ ー			
EM1	V8107700	DIODE	RK46	シ ョ ッ ト キ ー ダイ オ ー ド			
IC1	VI243100	EMI FILTER	DSS6NB32A271Q93A	L C フ ィ ル タ ー			01
L1	XT442A0R	IC	SI-8050S	I C	REGULATOR +5V		5
W1	VZ060700	CHOKO COIL	ELC15E221N 220uH	チ ョ ー ク コ イ ル			05
W2	--	WIRING ASSEMBLY	GND4 LUG-PIN L=90	G N D 4 束 線	(WP24390)		
W3	--	WIRING ASSEMBLY	GND4 LUG-PIN L=90	G N D 4 束 線	(WP24390)		
* WK611500		CIRCUIT BOARD	LCL	L C L シ ー ト	(WM24270)(X9412C0)		
* WK611600		CIRCUIT BOARD	LCR	L C R シ ー ト	(WM24270)(X9412C0)		
C2	US661470	CERAMIC CAPACITOR-CH (CHIP)	47P 50V J RECT.	チ ッ プ セ ラ (C H)			01
C3	US661470	CERAMIC CAPACITOR-CH (CHIP)	47P 50V J RECT.	チ ッ プ セ ラ (C H)			01
C4	US635100	CERAMIC CAPACITOR-F (CHIP)	0.100 16V Z RECT.	チ ッ プ セ ラ (F)			
C5	US635100	CERAMIC CAPACITOR-F (CHIP)	0.100 16V Z RECT.	チ ッ プ セ ラ (F)			
C6	WD758100	CERAMIC CAPACITOR (CHIP)	22U 6.3V K RECT.	チ ッ プ セ ラ			01
C7	US635100	CERAMIC CAPACITOR-F (CHIP)	0.100 16V Z RECT.	チ ッ プ セ ラ (F)			
C8	US634100	CERAMIC CAPACITOR-B (CHIP)	0.010 16V K RECT.	チ ッ プ セ ラ (B)			01
C9	WD758100	CERAMIC CAPACITOR (CHIP)	22U 6.3V K RECT.	チ ッ プ セ ラ			01
C10	US635100	CERAMIC CAPACITOR-F (CHIP)	0.100 16V Z RECT.	チ ッ プ セ ラ (F)			
C11	US634100	CERAMIC CAPACITOR-B (CHIP)	0.010 16V K RECT.	チ ッ プ セ ラ (B)			01
C12	WD758100	CERAMIC CAPACITOR (CHIP)	22U 6.3V K RECT.	チ ッ プ セ ラ			01
C13	US635100	CERAMIC CAPACITOR-F (CHIP)	0.100 16V Z RECT.	チ ッ プ セ ラ (F)			
C14	US634100	CERAMIC CAPACITOR-B (CHIP)	0.010 16V K RECT.	チ ッ プ セ ラ (B)			01
C15	WD758100	CERAMIC CAPACITOR (CHIP)	22U 6.3V K RECT.	チ ッ プ セ ラ			01
C16	US635100	CERAMIC CAPACITOR-F (CHIP)	0.100 16V Z RECT.	チ ッ プ セ ラ (F)			
C17	US634100	CERAMIC CAPACITOR-B (CHIP)	0.010 16V K RECT.	チ ッ プ セ ラ (B)			01
C18	US634100	CERAMIC CAPACITOR-B (CHIP)	0.010 16V K RECT.	チ ッ プ セ ラ (B)			01
C19	US635100	CERAMIC CAPACITOR-F (CHIP)	0.100 16V Z RECT.	チ ッ プ セ ラ (F)			
C20	WD758100	CERAMIC CAPACITOR (CHIP)	22U 6.3V K RECT.	チ ッ プ セ ラ			01
C21	US634100	CERAMIC CAPACITOR-B (CHIP)	0.010 16V K RECT.	チ ッ プ セ ラ (B)			01
C22	US634100	CERAMIC CAPACITOR-B (CHIP)	0.010 16V K RECT.	チ ッ プ セ ラ (B)			01
C23	US635100	CERAMIC CAPACITOR-F (CHIP)	0.100 16V Z RECT.	チ ッ プ セ ラ (F)			
C24	US635100	CERAMIC CAPACITOR-F (CHIP)	0.100 16V Z RECT.	チ ッ プ セ ラ (F)			
C25	WD758100	CERAMIC CAPACITOR (CHIP)	22U 6.3V K RECT.	チ ッ プ セ ラ			01
-27	WD758100	CERAMIC CAPACITOR (CHIP)	22U 6.3V K RECT.	チ ッ プ セ ラ			01
C28	US635100	CERAMIC CAPACITOR-F (CHIP)	0.100 16V Z RECT.	チ ッ プ セ ラ (F)			
C29	US634100	CERAMIC CAPACITOR-B (CHIP)	0.010 16V K RECT.	チ ッ プ セ ラ (B)			01
C30	US635100	CERAMIC CAPACITOR-F (CHIP)	0.100 16V Z RECT.	チ ッ プ セ ラ (F)			
C31	US634100	CERAMIC CAPACITOR-B (CHIP)	0.010 16V K RECT.	チ ッ プ セ ラ (B)			01
C32	US661470	CERAMIC CAPACITOR-CH (CHIP)	47P 50V J RECT.	チ ッ プ セ ラ (C H)			01
-34	US661470	CERAMIC CAPACITOR-CH (CHIP)	47P 50V J RECT.	チ ッ プ セ ラ (C H)			01
C35	US635100	CERAMIC CAPACITOR-F (CHIP)	0.100 16V Z RECT.	チ ッ プ セ ラ (F)			
C36	US661470	CERAMIC CAPACITOR-CH (CHIP)	47P 50V J RECT.	チ ッ プ セ ラ (C H)			01
C37	US661470	CERAMIC CAPACITOR-CH (CHIP)	47P 50V J RECT.	チ ッ プ セ ラ (C H)			01
C38	UF03810R	ELECTROLYTIC CAP. (CHIP)	100 16V	チ ッ プ ケ ミ コ ン			01
C39	US661470	CERAMIC CAPACITOR-CH (CHIP)	47P 50V J RECT.	チ ッ プ セ ラ (C H)			01
C40	US635100	CERAMIC CAPACITOR-F (CHIP)	0.100 16V Z RECT.	チ ッ プ セ ラ (F)			
C41	US661470	CERAMIC CAPACITOR-CH (CHIP)	47P 50V J RECT.	チ ッ プ セ ラ (C H)			01
-43	US661470	CERAMIC CAPACITOR-CH (CHIP)	47P 50V J RECT.	チ ッ プ セ ラ (C H)			01

*: New Parts

RANK: Japan only

LCL/LCR and MICVR/PNL/PNLS

REF NO.	PART NO.	DESCRIPTION		部 品 名	REMARKS	QTY	RANK
C44	UF03810R	ELECTROLYTIC CAP. (CHIP)	100 16V	チ ッ プ ケ ミ コ ン			01
C45	US661470	CERAMIC CAPACITOR-CH (CHIP)	47P 50V J RECT.	チ ッ プ セ ラ (C H)			01
-47	US661470	CERAMIC CAPACITOR-CH (CHIP)	47P 50V J RECT.	チ ッ プ セ ラ (C H)			01
C49	US661470	CERAMIC CAPACITOR-CH (CHIP)	47P 50V J RECT.	チ ッ プ セ ラ (C H)			01
-54	US661470	CERAMIC CAPACITOR-CH (CHIP)	47P 50V J RECT.	チ ッ プ セ ラ (C H)			01
C202	US065100	CERAMIC CAPACITOR-F (CHIP)	0.100 50V Z RECT.	チ ッ プ セ ラ F			
* C203	WN562400	ELECTROLYTIC CAP. (CHIP)	220.00 16.0V	チ ッ プ ケ ミ コ ン U D	}		
* C203	WQ357300	ELECTROLYTIC CAP. (CHIP)	220.00 16.0V	チ ッ プ ケ ミ コ ン			
C205	WF07860R	MONOLITHIC CERAMIC CAP.	12P 3.15KV J KAKUT	チ ッ プ 積 層 セ ラ コ ン			01
C206	US065100	CERAMIC CAPACITOR-F (CHIP)	0.100 50V Z RECT.	チ ッ プ セ ラ F			
C208	US065100	CERAMIC CAPACITOR-F (CHIP)	0.100 50V Z RECT.	チ ッ プ セ ラ F			
C209	UF037100	ELECTROLYTIC CAP. (CHIP)	10 16V	チ ッ プ ケ ミ コ ン			
* C211	WP188400	CHIP FILM CERAMIC CAP.	0.0820 100V J KAKU	チ ッ プ フ ィ ル ム コ ン			
CN1	VT619100	CONNECTOR BASE PIN	PH 5P SE	ベ ー ス 付 ポ ス ト			
* CN2	WN459800	FFC CONECTOR	6240 32P SE	F F C コ ネ ク タ ー			
CN4	V900600R	FFC CONNECTOR	52207 9P SE	F F C コ ネ ク タ ー			03
CN5	VZ24920R	CONNECTOR	52207-0890 8P	コ ネ ク タ ー			02
CN201	V900600R	FFC CONNECTOR	52207 9P SE	F F C コ ネ ク タ ー			03
CN202	V2915800	CONNECTOR BASE PIN	PH 4P SE	ベ ー ス 付 ポ ス ト			01
CN203	WE260900	CONNECTOR	BH 2P SE	B H コ ネ ク タ ー			03
D1	WG139300	DIODE	KDS4148U-RTK/P TE	ダ イ オ ー ド			
-6	WG139300	DIODE	KDS4148U-RTK/P TE	ダ イ オ ー ド			
D201	WG139300	DIODE	KDS4148U-RTK/P TE	ダ イ オ ー ド			
-208	WG139300	DIODE	KDS4148U-RTK/P TE	ダ イ オ ー ド			
* IC2	X9324A00	IC	DS99R104TSQX/NOPB	I C	LVDS		
L2	WG834800	COIL	DLW21HN900SQ2L	コ イ ル			
L4	V2449900	CHIP INDUCTANCE	BLM21PG600SN1D	チ ッ プ イ ン ダ ク タ			01
L5	V2449900	CHIP INDUCTANCE	BLM21PG600SN1D	チ ッ プ イ ン ダ ク タ			01
* L8	WP372900	CHIP INDUCTANCE	BLM18BB471SN1D	チ ッ プ イ ン ダ ク タ			
L201	V8901200	CHIP SOLID INDUCTANCE	BLM21PG221SN1D	チ ッ プ ソ リ ッ ド イ ン ダ			01
* L202	WN556100	COIL	CDH74NP-181JC	コ イ ル			
L203	VY65720R	CHIP INDUCTANCE	600 BK1608HM601-T	チ ッ プ イ ン ダ ク タ			01
R1	RD45000R	CHIP RESISTOR 1/16W	0.00 63M J RECT.	チ ッ プ 抵 抗			01
R2	RD454330	CHIP RESISTOR 1/16W	33.0 63M J RECT.	チ ッ プ 抵 抗			
R3	RD454330	CHIP RESISTOR 1/16W	33.0 63M J RECT.	チ ッ プ 抵 抗			
R6	RD457100	CHIP RESISTOR 1/16W	10.0K 63M J RECT.	チ ッ プ 抵 抗			
R7	RD457100	CHIP RESISTOR 1/16W	10.0K 63M J RECT.	チ ッ プ 抵 抗			
R8	RD45000R	CHIP RESISTOR 1/16W	0.00 63M J RECT.	チ ッ プ 抵 抗			01
R10	RD455100	CHIP RESISTOR 1/16W	100.0 63M J RECT.	チ ッ プ 抵 抗			
R11	RD454330	CHIP RESISTOR 1/16W	33.0 63M J RECT.	チ ッ プ 抵 抗			
-27	RD454330	CHIP RESISTOR 1/16W	33.0 63M J RECT.	チ ッ プ 抵 抗			
R29	RD45000R	CHIP RESISTOR 1/16W	0.00 63M J RECT.	チ ッ プ 抵 抗			01
-31	RD45000R	CHIP RESISTOR 1/16W	0.00 63M J RECT.	チ ッ プ 抵 抗			01
R204	RD15612R	CARBON RESISTOR (CHIP)	1.2K 1/4 J TP	チ ッ プ 抵 抗			
R205	RD150000	CARBON RESISTOR (CHIP)	0.0 1/4 J TP	チ ッ プ 抵 抗			01
R207	RD357100	CHIP RESISTOR 1/16W	10.0K 63M J RECT.	チ ッ プ 抵 抗			01
R209	RD350001	CHIP RESISTOR 1/16W	0 63M J RECT.	チ ッ プ 抵 抗			01
R211	RD15510R	CARBON RESISTOR (CHIP)	100.0 1/4 J TP	チ ッ プ 抵 抗			01
SW1	VU435300	SWITCH	SKHMQKE010	タ ク ト S W	A		
SW2	VU435300	SWITCH	SKHMQKE010	タ ク ト S W	B		
SW3	VU435300	SWITCH	SKHMQKE010	タ ク ト S W	C		
SW4	VU435300	SWITCH	SKHMQKE010	タ ク ト S W	D		
SW5	VU435300	SWITCH	SKHMQKE010	タ ク ト S W	E		
SW6	VU435300	SWITCH	SKHMQKE010	タ ク ト S W	DIRECT ACCESS		
SW201	VU435300	SWITCH	SKHMQKE010	タ ク ト S W	TAB [<]		
SW202	VU435300	SWITCH	SKHMQKE010	タ ク ト S W	TAB [>]		
SW203	VU435300	SWITCH	SKHMQKE010	タ ク ト S W	F		
SW204	VU435300	SWITCH	SKHMQKE010	タ ク ト S W	G		
SW205	VU435300	SWITCH	SKHMQKE010	タ ク ト S W	H		
SW206	VU435300	SWITCH	SKHMQKE010	タ ク ト S W	I		
SW207	VU435300	SWITCH	SKHMQKE010	タ ク ト S W	J		
SW208	VU435300	SWITCH	SKHMQKE010	タ ク ト S W	EXIT		
* T201	WB485100	INVERTER TRANSFORMER	CIOH175	イ ン バ ー タ ト ラ ン ス			
TR201	V906580R	TRANSISTOR	2SC4672-T100PQ	ト ラ ン ジ ス タ 2 S C			01
TR202	V906580R	TRANSISTOR	2SC4672-T100PQ	ト ラ ン ジ ス タ 2 S C			01
TR204	VY67760R	DIGITAL TRANSISTOR	DTC123JKA TP	デ ジ タ ル ト ラ ン ジ ス タ			01
TR205	VV655000	DIGITAL TRANSISTOR	DTA114EKA TP	デ ジ タ ル ト ラ ン ジ ス タ			
* WM239800		CIRCUIT BOARD	MICVR	M I C V R シ ー ト	(WM24250)(X9409C0)		
* WK611300		CIRCUIT BOARD	PNL	P N L シ ー ト	(WM24250)(X9409C0)		

*: New Parts

RANK: Japan only

MICVR/PNL/PNLS

REF NO.	PART NO.	DESCRIPTION		部 品 名	REMARKS	QTY	RANK
*	WK611900	CIRCUIT BOARD	PNLS	P N L S シ ー ト	(WM24250)(X9409C0)		
	V964210R	LED SPACER	LH-5-9.5	L E D ス ペ ー サ ー		6	01
C1	US062470	CERAMIC CAPACITOR-SL (CHIP)	470P 50V J RECT.	チ ッ プ セ ラ (S L)			
-16	US062470	CERAMIC CAPACITOR-SL (CHIP)	470P 50V J RECT.	チ ッ プ セ ラ (S L)			
C17	US064100	CERAMIC CAPACITOR-B (CHIP)	0.0100 50V K RECT.	チ ッ プ セ ラ (B)			
C18	UF037100	ELECTROLYTIC CAP. (CHIP)	10 16V	チ ッ プ ケ ミ コ ン			
C19	US064100	CERAMIC CAPACITOR-B (CHIP)	0.0100 50V K RECT.	チ ッ プ セ ラ (B)			
C20	UF037100	ELECTROLYTIC CAP. (CHIP)	10 16V	チ ッ プ ケ ミ コ ン			
C21	US14510R	CERAMIC CAPACITOR-F (CHIP)	0.1000 25V Z RECT.	チ ッ プ セ ラ (F)			01
C22	US064100	CERAMIC CAPACITOR-B (CHIP)	0.0100 50V K RECT.	チ ッ プ セ ラ (B)			
C23	US064100	CERAMIC CAPACITOR-B (CHIP)	0.0100 50V K RECT.	チ ッ プ セ ラ (B)			
C24	UF037100	ELECTROLYTIC CAP. (CHIP)	10 16V	チ ッ プ ケ ミ コ ン			
C25	US064100	CERAMIC CAPACITOR-B (CHIP)	0.0100 50V K RECT.	チ ッ プ セ ラ (B)			
C26	US14510R	CERAMIC CAPACITOR-F (CHIP)	0.1000 25V Z RECT.	チ ッ プ セ ラ (F)			01
C27	US14510R	CERAMIC CAPACITOR-F (CHIP)	0.1000 25V Z RECT.	チ ッ プ セ ラ (F)			01
C28	US064100	CERAMIC CAPACITOR-B (CHIP)	0.0100 50V K RECT.	チ ッ プ セ ラ (B)			
C29	UF11822R	ELECTROLYTIC CAP. (CHIP)	220 6.3V	チ ッ プ ケ ミ コ ン			01
C30	US064100	CERAMIC CAPACITOR-B (CHIP)	0.0100 50V K RECT.	チ ッ プ セ ラ (B)			
C31	US061330	CERAMIC CAPACITOR-CH (CHIP)	33P 50V J RECT.	チ ッ プ セ ラ (C H)			
C32	US064100	CERAMIC CAPACITOR-B (CHIP)	0.0100 50V K RECT.	チ ッ プ セ ラ (B)			
C33	US14510R	CERAMIC CAPACITOR-F (CHIP)	0.1000 25V Z RECT.	チ ッ プ セ ラ (F)			01
C34	UF11822R	ELECTROLYTIC CAP. (CHIP)	220 6.3V	チ ッ プ ケ ミ コ ン			01
C35	US064100	CERAMIC CAPACITOR-B (CHIP)	0.0100 50V K RECT.	チ ッ プ セ ラ (B)			
C36	US061330	CERAMIC CAPACITOR-CH (CHIP)	33P 50V J RECT.	チ ッ プ セ ラ (C H)			
C37	US064100	CERAMIC CAPACITOR-B (CHIP)	0.0100 50V K RECT.	チ ッ プ セ ラ (B)			
C38	US14510R	CERAMIC CAPACITOR-F (CHIP)	0.1000 25V Z RECT.	チ ッ プ セ ラ (F)			01
C39	UF11822R	ELECTROLYTIC CAP. (CHIP)	220 6.3V	チ ッ プ ケ ミ コ ン			01
C40	US064100	CERAMIC CAPACITOR-B (CHIP)	0.0100 50V K RECT.	チ ッ プ セ ラ (B)			
C41	UF11822R	ELECTROLYTIC CAP. (CHIP)	220 6.3V	チ ッ プ ケ ミ コ ン			01
C42	US064100	CERAMIC CAPACITOR-B (CHIP)	0.0100 50V K RECT.	チ ッ プ セ ラ (B)			
C43	UF11822R	ELECTROLYTIC CAP. (CHIP)	220 6.3V	チ ッ プ ケ ミ コ ン			01
C44	US064100	CERAMIC CAPACITOR-B (CHIP)	0.0100 50V K RECT.	チ ッ プ セ ラ (B)			
C45	UF11822R	ELECTROLYTIC CAP. (CHIP)	220 6.3V	チ ッ プ ケ ミ コ ン			01
C46	US064100	CERAMIC CAPACITOR-B (CHIP)	0.0100 50V K RECT.	チ ッ プ セ ラ (B)			
C47	UF11822R	ELECTROLYTIC CAP. (CHIP)	220 6.3V	チ ッ プ ケ ミ コ ン			01
C48	US064100	CERAMIC CAPACITOR-B (CHIP)	0.0100 50V K RECT.	チ ッ プ セ ラ (B)			
C49	UF11822R	ELECTROLYTIC CAP. (CHIP)	220 6.3V	チ ッ プ ケ ミ コ ン			01
C50	US064100	CERAMIC CAPACITOR-B (CHIP)	0.0100 50V K RECT.	チ ッ プ セ ラ (B)			
C51	US06168R	CERAMIC CAPACITOR-SL (CHIP)	68P 50V J RECT.	チ ッ プ セ ラ (S L)			01
C53	US14510R	CERAMIC CAPACITOR-F (CHIP)	0.1000 25V Z RECT.	チ ッ プ セ ラ (F)			01
C55	US14510R	CERAMIC CAPACITOR-F (CHIP)	0.1000 25V Z RECT.	チ ッ プ セ ラ (F)			01
C56	US14510R	CERAMIC CAPACITOR-F (CHIP)	0.1000 25V Z RECT.	チ ッ プ セ ラ (F)			01
C58	UF11822R	ELECTROLYTIC CAP. (CHIP)	220 6.3V	チ ッ プ ケ ミ コ ン			01
C60	US06168R	CERAMIC CAPACITOR-SL (CHIP)	68P 50V J RECT.	チ ッ プ セ ラ (S L)			01
C62	US14510R	CERAMIC CAPACITOR-F (CHIP)	0.1000 25V Z RECT.	チ ッ プ セ ラ (F)			01
C69	UF03810R	ELECTROLYTIC CAP. (CHIP)	100 16V	チ ッ プ ケ ミ コ ン			01
C70	US14510R	CERAMIC CAPACITOR-F (CHIP)	0.1000 25V Z RECT.	チ ッ プ セ ラ (F)			01
C74	US14510R	CERAMIC CAPACITOR-F (CHIP)	0.1000 25V Z RECT.	チ ッ プ セ ラ (F)			01
C77	US14510R	CERAMIC CAPACITOR-F (CHIP)	0.1000 25V Z RECT.	チ ッ プ セ ラ (F)			01
C79	US06168R	CERAMIC CAPACITOR-SL (CHIP)	68P 50V J RECT.	チ ッ プ セ ラ (S L)			01
C80	US14510R	CERAMIC CAPACITOR-F (CHIP)	0.1000 25V Z RECT.	チ ッ プ セ ラ (F)			01
C82	US14510R	CERAMIC CAPACITOR-F (CHIP)	0.1000 25V Z RECT.	チ ッ プ セ ラ (F)			01
C84	US061330	CERAMIC CAPACITOR-CH (CHIP)	33P 50V J RECT.	チ ッ プ セ ラ (C H)			
C85	US061330	CERAMIC CAPACITOR-CH (CHIP)	33P 50V J RECT.	チ ッ プ セ ラ (C H)			
C301	US14510R	CERAMIC CAPACITOR-F (CHIP)	0.1000 25V Z RECT.	チ ッ プ セ ラ (F)			01
C302	US14510R	CERAMIC CAPACITOR-F (CHIP)	0.1000 25V Z RECT.	チ ッ プ セ ラ (F)			01
CN1	VB39060R	CONNECTOR	PH 10P TE	ベ ー ス ポ ス ト			01
CN2	WF45040R	FFC CONNECTOR	52807 8P SE	F F C コ ネ ク タ			01
CN3	LB933020	CONNECTOR	VH 2P SE	ベ ー ス ポ ス ト			
CN4	VK015400	BASE POST CONNECTOR	PH 13P SE	ベ ー ス ポ ス ト			
CN6	VB39000R	CONNECTOR	PH 4P TE	ベ ー ス ポ ス ト			01
CN202	VB85890R	BASE-PIN	PH 10P SE	ベ ー ス ポ ス ト			01
CN301	VB38960R	CONNECTOR	PH 11P SE SIDE TYPE	ベ ー ス ポ ス ト			01
D1	WG139300	DIODE	KDS4148U-RTK/P TE	ダ イ オ ー ド			
D14	WG139300	DIODE	KDS4148U-RTK/P TE	ダ イ オ ー ド			
-88	WG139300	DIODE	KDS4148U-RTK/P TE	ダ イ オ ー ド			
D201	WG139300	DIODE	KDS4148U-RTK/P TE	ダ イ オ ー ド			
-204	WG139300	DIODE	KDS4148U-RTK/P TE	ダ イ オ ー ド			
IC1	XZ916300	IC	UPD780031AYGK-N09	I C	E-PNS2a LED/SWIOTCH DRIVER		
IC2	X5646200	IC	M34519M6-521FP	I C	LSC		04

*: New Parts

RANK: Japan only

MICVR/PNL/PNLS

REF NO.	PART NO.	DESCRIPTION		部	品	名	REMARKS	QTY	RANK
IC3	X5646200	IC	M34519M6-521FP	I		C	LSC		04
L1	GE300670	FERRIT BEAD	BL02RN2R1P1A TATET	フ	ェ	ラ			02
L2	V584810R	CHIP INDUCTANCE	56U ELJFC560JF	巻	線	チ			01
L3	V8901200	CHIP SOLID INDUCTANCE	BLM21PG221SN1D	チ	ッ	ソ			01
L4	V584810R	CHIP INDUCTANCE	56U ELJFC560JF	巻	線	チ			01
-6	V584810R	CHIP INDUCTANCE	56U ELJFC560JF	巻	線	チ			01
LD1	VG19760R	LED YELLOW-GREEN/RED	GL3ED8	2	色	L		SIGNAL	01
LD2	WM469900	LED GREEN	HFG223P-BW14	L		E		FADE IN/OUT	
LD3	WM469900	LED GREEN	HFG223P-BW14	L		E		STYLE [POP & ROCK]	
LD4	WM469900	LED GREEN	HFG223P-BW14	L		E		STYLE [LATIN]	
LD5	WF300900	LED (CHIP) ORANGE	SML-512DW	チ	ッ	ブ		STYLE CONTROL [ACMP]	01
LD6	WM469900	LED GREEN	HFG223P-BW14	L		E		STYLE [BALLAD]	
LD7	WM469900	LED GREEN	HFG223P-BW14	L		E		STYLE [BALLROOM]	
LD8	WM469900	LED GREEN	HFG223P-BW14	L		E		MIC [EFFECT]	
LD9	WM469900	LED GREEN	HFG223P-BW14	L		E		STYLE [DANCE]	
LD10	WM469900	LED GREEN	HFG223P-BW14	L		E		STYLE [MOVIE & SHOW]	
LD11	WN414500	LED	HFR8239P(P1D2)-BW	L		E		STYLE CONTROL [OTS LINK]	
LD12	WF30100R	LED (CHIP) GREEN	SML-012PTT86A	チ	ッ	ブ		STYLE CONTROL INTRO [I]	01
LD13	WF300900	LED (CHIP) ORANGE	SML-512DW	チ	ッ	ブ		STYLE CONTROL INTRO [I]	01
LD14	WF30100R	LED (CHIP) GREEN	SML-012PTT86A	チ	ッ	ブ		STYLE CONTROL INTRO [II]	01
LD15	WF300900	LED (CHIP) ORANGE	SML-512DW	チ	ッ	ブ		STYLE CONTROL INTRO [II]	01
LD16	WF30100R	LED (CHIP) GREEN	SML-012PTT86A	チ	ッ	ブ		MAIN VARIATION [A]	01
LD17	WF300900	LED (CHIP) ORANGE	SML-512DW	チ	ッ	ブ		MAIN VARIATION [A]	01
LD18	WM469900	LED GREEN	HFG223P-BW14	L		E		STYLE [SWING & JAZZ]	
LD19	WM469900	LED GREEN	HFG223P-BW14	L		E		STYLE [ENTERTAINER]	
LD20	WN414500	LED	HFR8239P(P1D2)-BW	L		E		STYLE CONTROL [AUTO FILL IN]	
LD21	WF30100R	LED (CHIP) GREEN	SML-012PTT86A	チ	ッ	ブ		STYLE CONTROL INTRO [III]	01
LD22	WF300900	LED (CHIP) ORANGE	SML-512DW	チ	ッ	ブ		STYLE CONTROL INTRO [III]	01
LD23	WF30100R	LED (CHIP) GREEN	SML-012PTT86A	チ	ッ	ブ		MAIN VARIATION [C]	01
LD24	WF300900	LED (CHIP) ORANGE	SML-512DW	チ	ッ	ブ		MAIN VARIATION [C]	01
LD25	WM469900	LED GREEN	HFG223P-BW14	L		E		STYLE [R & B]	
LD26	WM469900	LED GREEN	HFG223P-BW14	L		E		STYLE [WORLD]	
LD27	WF30100R	LED (CHIP) GREEN	SML-012PTT86A	チ	ッ	ブ		MAIN VARIATION [B]	01
LD28	WF300900	LED (CHIP) ORANGE	SML-512DW	チ	ッ	ブ		MAIN VARIATION [B]	01
LD29	WF30100R	LED (CHIP) GREEN	SML-012PTT86A	チ	ッ	ブ		MAIN VARIATION [D]	01
LD30	WF300900	LED (CHIP) ORANGE	SML-512DW	チ	ッ	ブ		MAIN VARIATION [D]	01
LD31	WF30100R	LED (CHIP) GREEN	SML-012PTT86A	チ	ッ	ブ		STYLE CONTROL [-#-]	01
LD32	WF300900	LED (CHIP) ORANGE	SML-512DW	チ	ッ	ブ		STYLE CONTROL [-#-]	01
LD33	WM469900	LED GREEN	HFG223P-BW14	L		E		STYLE [COUNTRY]	
LD34	WM469900	LED GREEN	HFG223P-BW14	L		E		STYLE [FILE ACCESS]	
LD35	WF30100R	LED (CHIP) GREEN	SML-012PTT86A	チ	ッ	ブ		ENDING/rit. [I]	01
LD36	WF300900	LED (CHIP) ORANGE	SML-512DW	チ	ッ	ブ		ENDING/rit. [I]	01
LD37	WM469900	LED GREEN	HFG223P-BW14	L		E		SONG [LOOP]	
LD38	WM469900	LED GREEN	HFG223P-BW14	L		E		MIC [VOCAL HARMONY]	
LD39	WF30100R	LED (CHIP) GREEN	SML-012PTT86A	チ	ッ	ブ		ENDING/rit. [II]	01
LD40	WF300900	LED (CHIP) ORANGE	SML-512DW	チ	ッ	ブ		ENDING/rit. [II]	01
LD41	WN414500	LED	HFR8239P(P1D2)-BW	L		E		SONG [●]	
LD42	WN414500	LED	HFR8239P(P1D2)-BW	L		E		SONG [METRONOME]	
LD43	WF30100R	LED (CHIP) GREEN	SML-012PTT86A	チ	ッ	ブ		MULTI PAD CONTROL [1]	01
LD44	WF300900	LED (CHIP) ORANGE	SML-512DW	チ	ッ	ブ		MULTI PAD CONTROL [1]	01
LD45	WM469900	LED GREEN	HFG223P-BW14	L		E		MIC [TALK]	
LD46	WF30100R	LED (CHIP) GREEN	SML-012PTT86A	チ	ッ	ブ		MULTI PAD CONTROL [2]	01
LD47	WF300900	LED (CHIP) ORANGE	SML-512DW	チ	ッ	ブ		MULTI PAD CONTROL [2]	01
LD48	WF30100R	LED (CHIP) GREEN	SML-012PTT86A	チ	ッ	ブ		ENDING/rit. [III]	01
LD49	WF300900	LED (CHIP) ORANGE	SML-512DW	チ	ッ	ブ		ENDING/rit. [III]	01
LD50	WM469900	LED GREEN	HFG223P-BW14	L		E		SONG [I]	
LD51	WM469900	LED GREEN	HFG223P-BW14	L		E		SONG [III]	
LD52	WM469900	LED GREEN	HFG223P-BW14	L		E		SONG [II]	
LD53	WM469900	LED GREEN	HFG223P-BW14	L		E		SONG [IV]	
LD54	WF30100R	LED (CHIP) GREEN	SML-012PTT86A	チ	ッ	ブ		MULTI PAD CONTROL [3]	01
LD55	WF300900	LED (CHIP) ORANGE	SML-512DW	チ	ッ	ブ		MULTI PAD CONTROL [3]	01
LD56	WF300900	LED (CHIP) ORANGE	SML-512DW	チ	ッ	ブ		STYLE CONTROL [■]	01
LD57	VG19760R	LED YELLOW-GREEN/RED	GL3ED8	2	色	L		SONG [▶/■]	01
LD58	WF30100R	LED (CHIP) GREEN	SML-012PTT86A	チ	ッ	ブ		MULTI PAD CONTROL [4]	01
LD59	WF300900	LED (CHIP) ORANGE	SML-512DW	チ	ッ	ブ		MULTI PAD CONTROL [4]	01
LD60	WF300900	LED (CHIP) ORANGE	SML-512DW	チ	ッ	ブ		STYLE CONTROL [▼]	01
LD61	VG19760R	LED YELLOW-GREEN/RED	GL3ED8	2	色	L		SONG [SP 1]	01
LD62	VG19760R	LED YELLOW-GREEN/RED	GL3ED8	2	色	L		SONG [SP 3]	01
LD63	WF30100R	LED (CHIP) GREEN	SML-012PTT86A	チ	ッ	ブ		STYLE CONTROL [▶/■]	01
LD64	WF300900	LED (CHIP) ORANGE	SML-512DW	チ	ッ	ブ		STYLE CONTROL [▶/■]	01

*: New Parts

RANK: Japan only

MICVR/PNL/PNLS

REF NO.	PART NO.	DESCRIPTION		部	品	名	REMARKS	QTY	RANK
LD65	VG19760R	LED YELLOW-GREEN/RED	GL3ED8	2	色	L E D	SONG [SP 2]		01
LD66	VG19760R	LED YELLOW-GREEN/RED	GL3ED8	2	色	L E D	SONG [SP 4]		01
LD201	WF30100R	LED (CHIP) GREEN	SML-012PTT86A	チ	ッ	ブ L E D	ART. 1		01
LD202	WF300900	LED (CHIP) ORANGE	SML-512DW	チ	ッ	ブ L E D	ART. 1		01
LD203	WF30100R	LED (CHIP) GREEN	SML-012PTT86A	チ	ッ	ブ L E D	ART. 2		01
LD204	WF300900	LED (CHIP) ORANGE	SML-512DW	チ	ッ	ブ L E D	ART. 2		01
R13	RD357100	CHIP RESISTOR 1/16W	10.0K 63M J RECT.	チ	ッ	ブ 抵 抗			01
-24	RD357100	CHIP RESISTOR 1/16W	10.0K 63M J RECT.	チ	ッ	ブ 抵 抗			01
R29	RD357100	CHIP RESISTOR 1/16W	10.0K 63M J RECT.	チ	ッ	ブ 抵 抗			01
-37	RD357100	CHIP RESISTOR 1/16W	10.0K 63M J RECT.	チ	ッ	ブ 抵 抗			01
R38	RD356100	CHIP RESISTOR 1/16W	1.0K 63M J RECT.	チ	ッ	ブ 抵 抗			01
R39	RD350001	CHIP RESISTOR 1/16W	0 63M J RECT.	チ	ッ	ブ 抵 抗			01
R40	RD356100	CHIP RESISTOR 1/16W	1.0K 63M J RECT.	チ	ッ	ブ 抵 抗			01
R41	RD35433R	CHIP RESISTOR 1/16W	33.0 63M J RECT.	チ	ッ	ブ 抵 抗			01
-47	RD35433R	CHIP RESISTOR 1/16W	33.0 63M J RECT.	チ	ッ	ブ 抵 抗			01
R48	RD357100	CHIP RESISTOR 1/16W	10.0K 63M J RECT.	チ	ッ	ブ 抵 抗			01
-66	RD357100	CHIP RESISTOR 1/16W	10.0K 63M J RECT.	チ	ッ	ブ 抵 抗			01
R67	RD356100	CHIP RESISTOR 1/16W	1.0K 63M J RECT.	チ	ッ	ブ 抵 抗			01
R68	RD356680	CHIP RESISTOR 1/16W	6.8K 63M J RECT.	チ	ッ	ブ 抵 抗			01
R69	RD357100	CHIP RESISTOR 1/16W	10.0K 63M J RECT.	チ	ッ	ブ 抵 抗			01
-75	RD357100	CHIP RESISTOR 1/16W	10.0K 63M J RECT.	チ	ッ	ブ 抵 抗			01
R76	RD354680	CHIP RESISTOR 1/16W	68.0 63M J RECT.	チ	ッ	ブ 抵 抗			01
-79	RD354680	CHIP RESISTOR 1/16W	68.0 63M J RECT.	チ	ッ	ブ 抵 抗			01
R80	RD357100	CHIP RESISTOR 1/16W	10.0K 63M J RECT.	チ	ッ	ブ 抵 抗			01
-91	RD357100	CHIP RESISTOR 1/16W	10.0K 63M J RECT.	チ	ッ	ブ 抵 抗			01
R92	RD356100	CHIP RESISTOR 1/16W	1.0K 63M J RECT.	チ	ッ	ブ 抵 抗			01
R93	RD357100	CHIP RESISTOR 1/16W	10.0K 63M J RECT.	チ	ッ	ブ 抵 抗			01
R94	RD356680	CHIP RESISTOR 1/16W	6.8K 63M J RECT.	チ	ッ	ブ 抵 抗			01
R95	RD357100	CHIP RESISTOR 1/16W	10.0K 63M J RECT.	チ	ッ	ブ 抵 抗			01
-101	RD357100	CHIP RESISTOR 1/16W	10.0K 63M J RECT.	チ	ッ	ブ 抵 抗			01
R102	RD354680	CHIP RESISTOR 1/16W	68.0 63M J RECT.	チ	ッ	ブ 抵 抗			01
-105	RD354680	CHIP RESISTOR 1/16W	68.0 63M J RECT.	チ	ッ	ブ 抵 抗			01
R106	RD357100	CHIP RESISTOR 1/16W	10.0K 63M J RECT.	チ	ッ	ブ 抵 抗			01
-110	RD357100	CHIP RESISTOR 1/16W	10.0K 63M J RECT.	チ	ッ	ブ 抵 抗			01
R111	RD354680	CHIP RESISTOR 1/16W	68.0 63M J RECT.	チ	ッ	ブ 抵 抗			01
R112	RD354680	CHIP RESISTOR 1/16W	68.0 63M J RECT.	チ	ッ	ブ 抵 抗			01
R113	RD355390	CHIP RESISTOR 1/16W	390.0 63M J RECT.	チ	ッ	ブ 抵 抗			01
R114	RD354680	CHIP RESISTOR 1/16W	68.0 63M J RECT.	チ	ッ	ブ 抵 抗			01
R115	RD355390	CHIP RESISTOR 1/16W	390.0 63M J RECT.	チ	ッ	ブ 抵 抗			01
-117	RD355390	CHIP RESISTOR 1/16W	390.0 63M J RECT.	チ	ッ	ブ 抵 抗			01
R118	RD354680	CHIP RESISTOR 1/16W	68.0 63M J RECT.	チ	ッ	ブ 抵 抗			01
-121	RD354680	CHIP RESISTOR 1/16W	68.0 63M J RECT.	チ	ッ	ブ 抵 抗			01
R122	RD355390	CHIP RESISTOR 1/16W	390.0 63M J RECT.	チ	ッ	ブ 抵 抗			01
-125	RD355390	CHIP RESISTOR 1/16W	390.0 63M J RECT.	チ	ッ	ブ 抵 抗			01
R126	RD354680	CHIP RESISTOR 1/16W	68.0 63M J RECT.	チ	ッ	ブ 抵 抗			01
-129	RD354680	CHIP RESISTOR 1/16W	68.0 63M J RECT.	チ	ッ	ブ 抵 抗			01
R130	RD355390	CHIP RESISTOR 1/16W	390.0 63M J RECT.	チ	ッ	ブ 抵 抗			01
-133	RD355390	CHIP RESISTOR 1/16W	390.0 63M J RECT.	チ	ッ	ブ 抵 抗			01
R134	RD354680	CHIP RESISTOR 1/16W	68.0 63M J RECT.	チ	ッ	ブ 抵 抗			01
R135	RD354680	CHIP RESISTOR 1/16W	68.0 63M J RECT.	チ	ッ	ブ 抵 抗			01
R136	RD355390	CHIP RESISTOR 1/16W	390.0 63M J RECT.	チ	ッ	ブ 抵 抗			01
R137	RD354680	CHIP RESISTOR 1/16W	68.0 63M J RECT.	チ	ッ	ブ 抵 抗			01
R138	RD355390	CHIP RESISTOR 1/16W	390.0 63M J RECT.	チ	ッ	ブ 抵 抗			01
-141	RD355390	CHIP RESISTOR 1/16W	390.0 63M J RECT.	チ	ッ	ブ 抵 抗			01
R142	RD354680	CHIP RESISTOR 1/16W	68.0 63M J RECT.	チ	ッ	ブ 抵 抗			01
R143	RD355390	CHIP RESISTOR 1/16W	390.0 63M J RECT.	チ	ッ	ブ 抵 抗			01
R144	RD354680	CHIP RESISTOR 1/16W	68.0 63M J RECT.	チ	ッ	ブ 抵 抗			01
R145	RD355390	CHIP RESISTOR 1/16W	390.0 63M J RECT.	チ	ッ	ブ 抵 抗			01
R146	RD354680	CHIP RESISTOR 1/16W	68.0 63M J RECT.	チ	ッ	ブ 抵 抗			01
R147	RD355390	CHIP RESISTOR 1/16W	390.0 63M J RECT.	チ	ッ	ブ 抵 抗			01
R148	RD354680	CHIP RESISTOR 1/16W	68.0 63M J RECT.	チ	ッ	ブ 抵 抗			01
R149	RD355390	CHIP RESISTOR 1/16W	390.0 63M J RECT.	チ	ッ	ブ 抵 抗			01
R150	RD35418R	CHIP RESISTOR 1/16W	18.0 63M J RECT.	チ	ッ	ブ 抵 抗			01
R151	RD35418R	CHIP RESISTOR 1/16W	18.0 63M J RECT.	チ	ッ	ブ 抵 抗			01
R152	RD355330	CHIP RESISTOR 1/16W	330.0 63M J RECT.	チ	ッ	ブ 抵 抗			01
-155	RD355330	CHIP RESISTOR 1/16W	330.0 63M J RECT.	チ	ッ	ブ 抵 抗			01
R156	RD35418R	CHIP RESISTOR 1/16W	18.0 63M J RECT.	チ	ッ	ブ 抵 抗			01
-165	RD35418R	CHIP RESISTOR 1/16W	18.0 63M J RECT.	チ	ッ	ブ 抵 抗			01
R166	RD15510R	CARBON RESISTOR (CHIP)	100.0 1/4 J TP	チ	ッ	ブ 抵 抗			01
R169	RD354470	CHIP RESISTOR 1/16W	47.0 63M J RECT.	チ	ッ	ブ 抵 抗			01

*: New Parts

RANK: Japan only

MICVR/PNL/PNLS

REF NO.	PART NO.	DESCRIPTION		部	品	名	REMARKS	QTY	RANK
R170	RD355120	CHIP RESISTOR 1/16W	120.0 63M J RECT.	チ	ッ	ブ 抵 抗			01
R171	RD355120	CHIP RESISTOR 1/16W	120.0 63M J RECT.	チ	ッ	ブ 抵 抗			01
R172	RD350001	CHIP RESISTOR 1/16W	0 63M J RECT.	チ	ッ	ブ 抵 抗			01
-174	RD350001	CHIP RESISTOR 1/16W	0 63M J RECT.	チ	ッ	ブ 抵 抗			01
R175	RD355150	CHIP RESISTOR 1/16W	150.0 63M J RECT.	チ	ッ	ブ 抵 抗			
-179	RD355150	CHIP RESISTOR 1/16W	150.0 63M J RECT.	チ	ッ	ブ 抵 抗			
R180	RD355100	CHIP RESISTOR 1/16W	100.0 63M J RECT.	チ	ッ	ブ 抵 抗			
-185	RD355100	CHIP RESISTOR 1/16W	100.0 63M J RECT.	チ	ッ	ブ 抵 抗			
R186	RD354680	CHIP RESISTOR 1/16W	68.0 63M J RECT.	チ	ッ	ブ 抵 抗			
R187	RD354680	CHIP RESISTOR 1/16W	68.0 63M J RECT.	チ	ッ	ブ 抵 抗			
R301	RD350001	CHIP RESISTOR 1/16W	0 63M J RECT.	チ	ッ	ブ 抵 抗			01
SW1	WG31840R	TACT SWITCH	SKRGAMD010	タ	ク	ト S W	CHANNEL ON/OFF		01
SW2	WG31840R	TACT SWITCH	SKRGAMD010	タ	ク	ト S W	BALANCE		01
SW3	WG31840R	TACT SWITCH	SKRGAMD010	タ	ク	ト S W	FADE IN/OUT		01
SW4	WG31840R	TACT SWITCH	SKRGAMD010	タ	ク	ト S W	STYLE [POP & ROCK]		01
SW5	WG31840R	TACT SWITCH	SKRGAMD010	タ	ク	ト S W	STYLE [LATIN]		01
SW6	WG31840R	TACT SWITCH	SKRGAMD010	タ	ク	ト S W	DEMO		01
SW7	WG31840R	TACT SWITCH	SKRGAMD010	タ	ク	ト S W	STYLE [BALLAD]		01
SW8	WG31840R	TACT SWITCH	SKRGAMD010	タ	ク	ト S W	STYLE [BALLROOM]		01
SW9	WG31840R	TACT SWITCH	SKRGAMD010	タ	ク	ト S W	MIC [EFFECT]		01
SW10	WG31840R	TACT SWITCH	SKRGAMD010	タ	ク	ト S W	STYLE CONTROL [ACMP]		01
SW11	WG31840R	TACT SWITCH	SKRGAMD010	タ	ク	ト S W	STYLE [DANCE]		01
SW12	WG31840R	TACT SWITCH	SKRGAMD010	タ	ク	ト S W	STYLE [MOVIE & SHOW]		01
SW13	WG31840R	TACT SWITCH	SKRGAMD010	タ	ク	ト S W	STYLE CONTROL [OTS LINK]		01
SW14	WG31840R	TACT SWITCH	SKRGAMD010	タ	ク	ト S W	STYLE CONTROL INTRO [I]		01
SW15	WG31840R	TACT SWITCH	SKRGAMD010	タ	ク	ト S W	STYLE CONTROL INTRO [II]		01
SW16	WG31840R	TACT SWITCH	SKRGAMD010	タ	ク	ト S W	STYLE [SWING & JAZZ]		01
SW17	WG31840R	TACT SWITCH	SKRGAMD010	タ	ク	ト S W	STYLE [ENTERTAINER]		01
SW18	WG31840R	TACT SWITCH	SKRGAMD010	タ	ク	ト S W	TAP TEMPO		01
SW19	WG31840R	TACT SWITCH	SKRGAMD010	タ	ク	ト S W	STYLE CONTROL [AUTO FILL IN]		01
SW20	WG31840R	TACT SWITCH	SKRGAMD010	タ	ク	ト S W	STYLE CONTROL INTRO [III]		01
SW21	WG31840R	TACT SWITCH	SKRGAMD010	タ	ク	ト S W	MAIN VARIATION [A]		01
SW22	WG31840R	TACT SWITCH	SKRGAMD010	タ	ク	ト S W	STYLE [R & B]		01
SW23	WG31840R	TACT SWITCH	SKRGAMD010	タ	ク	ト S W	STYLE [WORLD]		01
SW24	WG31840R	TACT SWITCH	SKRGAMD010	タ	ク	ト S W	TEMPO [-]		01
SW25	WG31840R	TACT SWITCH	SKRGAMD010	タ	ク	ト S W	MAIN VARIATION [C]		01
SW26	WG31840R	TACT SWITCH	SKRGAMD010	タ	ク	ト S W	MAIN VARIATION [B]		01
SW27	WG31840R	TACT SWITCH	SKRGAMD010	タ	ク	ト S W	STYLE [COUNTRY]		01
SW28	WG31840R	TACT SWITCH	SKRGAMD010	タ	ク	ト S W	STYLE [FILE ACCESS]		01
SW29	WG31840R	TACT SWITCH	SKRGAMD010	タ	ク	ト S W	TEMPO [+]		01
SW30	WG31840R	TACT SWITCH	SKRGAMD010	タ	ク	ト S W	MAIN VARIATION [D]		01
SW31	WG31840R	TACT SWITCH	SKRGAMD010	タ	ク	ト S W	STYLE CONTROL [BREAK]		01
SW32	WG31840R	TACT SWITCH	SKRGAMD010	タ	ク	ト S W	ENDING/rit. [I]		01
SW33	WG31840R	TACT SWITCH	SKRGAMD010	タ	ク	ト S W	SONG [LOOP]		01
SW34	WG31840R	TACT SWITCH	SKRGAMD010	タ	ク	ト S W	TRANPOSE [-]		01
SW35	WG31840R	TACT SWITCH	SKRGAMD010	タ	ク	ト S W	MULTI PAD CONTROL [SELECT]		01
SW36	WG31840R	TACT SWITCH	SKRGAMD010	タ	ク	ト S W	MIC [VH TYPE SELECT]		01
SW37	WG31840R	TACT SWITCH	SKRGAMD010	タ	ク	ト S W	MIC [VOCAL HARMONY]		01
SW38	WG31840R	TACT SWITCH	SKRGAMD010	タ	ク	ト S W	ENDING/rit. [II]		01
SW39	WG31840R	TACT SWITCH	SKRGAMD010	タ	ク	ト S W	SONG [●]		01
SW40	WG31840R	TACT SWITCH	SKRGAMD010	タ	ク	ト S W	SONG [METRONOME]		01
SW41	WG31840R	TACT SWITCH	SKRGAMD010	タ	ク	ト S W	MULTI PAD CONTROL [1]		01
SW42	WG31840R	TACT SWITCH	SKRGAMD010	タ	ク	ト S W	MIC [MIC SETTING]		01
SW43	WG31840R	TACT SWITCH	SKRGAMD010	タ	ク	ト S W	MIC [TALK]		01
SW44	WG31840R	TACT SWITCH	SKRGAMD010	タ	ク	ト S W	ENDING/rit. [III]		01
SW45	WG31840R	TACT SWITCH	SKRGAMD010	タ	ク	ト S W	SONG [I]		01
SW46	WG31840R	TACT SWITCH	SKRGAMD010	タ	ク	ト S W	SONG [■]		01
SW47	WG31840R	TACT SWITCH	SKRGAMD010	タ	ク	ト S W	TRANPOSE [+]		01
SW48	WG31840R	TACT SWITCH	SKRGAMD010	タ	ク	ト S W	MULTI PAD CONTROL [2]		01
SW49	WG31840R	TACT SWITCH	SKRGAMD010	タ	ク	ト S W	SONG [III]		01
SW50	WG31840R	TACT SWITCH	SKRGAMD010	タ	ク	ト S W	SONG [▶/■]		01
SW51	WG31840R	TACT SWITCH	SKRGAMD010	タ	ク	ト S W	SONG [LYRICS/TEXT]		01
SW52	WG31840R	TACT SWITCH	SKRGAMD010	タ	ク	ト S W	STYLE CONTROL [■]		01
SW53	WG31840R	TACT SWITCH	SKRGAMD010	タ	ク	ト S W	SONG [II]		01
SW54	WG31840R	TACT SWITCH	SKRGAMD010	タ	ク	ト S W	SONG [IV]		01
SW55	WG31840R	TACT SWITCH	SKRGAMD010	タ	ク	ト S W	MULTI PAD CONTROL [3]		01
SW56	WG31840R	TACT SWITCH	SKRGAMD010	タ	ク	ト S W	SONG [◀◀]		01
SW57	WG31840R	TACT SWITCH	SKRGAMD010	タ	ク	ト S W	MIXING CONSOLE		01
SW58	WG31840R	TACT SWITCH	SKRGAMD010	タ	ク	ト S W	STYLE CONTROL [▼]		01
SW59	WG31840R	TACT SWITCH	SKRGAMD010	タ	ク	ト S W	SONG [SP 1]		01

*: New Parts

RANK: Japan only

MICVR/PNL/PNLS and MK61L and MKH-D/EMKS-FD(E-BUS)ON MKH-D and EMKS-FD(E-BUS)ON MKH-D

REF NO.	PART NO.	DESCRIPTION	部 品 名	REMARKS	QTY	RANK
SW60	WG31840R	TACT SWITCH	SKRGAMD010	タ ク ト S W		01
SW61	WG31840R	TACT SWITCH	SKRGAMD010	タ ク ト S W	SONG [SP 3]	01
SW62	WG31840R	TACT SWITCH	SKRGAMD010	タ ク ト S W	MULTI PAD CONTROL [4]	01
SW63	WG31840R	TACT SWITCH	SKRGAMD010	タ ク ト S W	SONG [▶▶]	01
SW64	WG31840R	TACT SWITCH	SKRGAMD010	タ ク ト S W	SONG [SCORE]	01
SW65	WG31840R	TACT SWITCH	SKRGAMD010	タ ク ト S W	MULTI PAD CONTROL [STOP]	01
SW66	WG31840R	TACT SWITCH	SKRGAMD010	タ ク ト S W	STYLE CONTROL [▶/■]	01
SW67	WG31840R	TACT SWITCH	SKRGAMD010	タ ク ト S W	SONG [SP 2]	01
SW201	WG31840R	TACT SWITCH	SKRGAMD010	タ ク ト S W	SONG [SP 4]	01
SW202	WG31840R	TACT SWITCH	SKRGAMD010	タ ク ト S W	UPPER OCTAVE [-]	01
SW203	WG31840R	TACT SWITCH	SKRGAMD010	タ ク ト S W	ART. 1	01
SW204	WG31840R	TACT SWITCH	SKRGAMD010	タ ク ト S W	UPPER OCTAVE [+]	01
TA1	V856660R	TRANSISTOR ARRAY	TD62785FG-(5,EL)	ト ラ ン ジ ス タ ア レ イ	ART. 2	05
TA2	WC71000R	TRANSISTOR ARRAY	M54562FP-DB1J	ト ラ ン ジ ス タ ア レ イ		
-6	WC71000R	TRANSISTOR ARRAY	M54562FP-DB1J	ト ラ ン ジ ス タ ア レ イ		
TR1	WA01310R	DIGITAL TRANSISTOR	DTDG23YP T100	デ ジ タ ル ト ラ ン ジ ス タ		01
-6	WA01310R	DIGITAL TRANSISTOR	DTDG23YP T100	デ ジ タ ル ト ラ ン ジ ス タ		01
VR1	WN562700	SLIDE VARIABLE RESISTOR	B 10.0K RS20111A9A	ス ラ イ ド V R	ASSIGN	
VR301	VJ78950R	VARIABLE RESISTOR	B 10.0K RK09K1130A	ロ ー タ リ ー V R	INPUT VOLUME	01
VR302	VT683100	ROTARY VARIABLE RESISTOR	A 10.0K RK14K12C	ニ 連 ロ ー タ リ ー V R	MASTER VOLUME	03
X1	WM775700	CERAMIC RESONATOR	8.38MHz CSTCE8M38G55	セ ラ ミ ッ ク 振 動 子		
	WD80010R	CIRCUIT BOARD	MK61L	シ ー ト M K 6 1 L	(WD80020)(X6578C0)	
	--	JUMPER CABLE	0.55	ジャンパー線	(VA07890)	
CN001	VM689000	FFC CONNECTOR	52045 23P TE	F F C コ ネ ク タ ー		
CN002	VB858200	BASE-PIN	PH 3P SE	ベ ー ス ポ ス ト		
D0001	VB941200	DIODE	1SS133,1SS176 TE	ダ イ オ ー ド		
-75	VB941200	DIODE	1SS133,1SS176 TE	ダ イ オ ー ド		
	WD80100R	CIRCUIT BOARD	MKH-D	M K H - D シ ー ト	(WD78570)(X6579B0)	
	WE623100	CIRCUIT BOARD	EMKS-FD(E-BUS)ON MKH-D	E M K S - F D シ ー ト		
CN002	WK372800	FFC CONNECTOR	5597 3P SE	F F C 用 コ ネ ク タ ー		
CN004	VM689000	FFC CONNECTOR	52045 23P TE	F F C コ ネ ク タ ー		
CN005	VB858200	BASE-PIN	PH 3P SE	ベ ー ス ポ ス ト		
D0001	VB941200	DIODE	1SS133,1SS176 TE	ダ イ オ ー ド		
-48	VB941200	DIODE	1SS133,1SS176 TE	ダ イ オ ー ド		
	WE623100	CIRCUIT BOARD	EMKS-FD(E-BUS)ON MKH-D	E M K S - F D シ ー ト	(WE62270)(X6577A0)	
	--	PC SUPPORT	JIS R33 T=5	基 板 サ ポ ー ト	(WB72300)	
C0005	US135100	CERAMIC CAPACITOR-F (CHIP)	0.1000 16V Z RECT.	チ ッ プ セ ラ (F)		
C0009	UF118470	ELECTROLYTIC CAP. (CHIP)	470 6.3V	チ ッ プ ケ ミ コ ン		
C0011	US135100	CERAMIC CAPACITOR-F (CHIP)	0.1000 16V Z RECT.	チ ッ プ セ ラ (F)		
C0021	UF01747R	ELECTROLYTIC CAP. (CHIP)	47 6.3V	チ ッ プ ケ ミ コ ン		01
C0022	US135100	CERAMIC CAPACITOR-F (CHIP)	0.1000 16V Z RECT.	チ ッ プ セ ラ (F)		
C0023	US135100	CERAMIC CAPACITOR-F (CHIP)	0.1000 16V Z RECT.	チ ッ プ セ ラ (F)		
C0027	US135100	CERAMIC CAPACITOR-F (CHIP)	0.1000 16V Z RECT.	チ ッ プ セ ラ (F)		
C0028	US135100	CERAMIC CAPACITOR-F (CHIP)	0.1000 16V Z RECT.	チ ッ プ セ ラ (F)		
C0029	UF01747R	ELECTROLYTIC CAP. (CHIP)	47 6.3V	チ ッ プ ケ ミ コ ン		01
C0030	US135100	CERAMIC CAPACITOR-F (CHIP)	0.1000 16V Z RECT.	チ ッ プ セ ラ (F)		
C0031	UF018100	ELECTROLYTIC CAP. (CHIP)	100 6.3V	チ ッ プ ケ ミ コ ン		
C0032	US135100	CERAMIC CAPACITOR-F (CHIP)	0.1000 16V Z RECT.	チ ッ プ セ ラ (F)		
C0033	US064100	CERAMIC CAPACITOR-B (CHIP)	0.0100 50V K RECT.	チ ッ プ セ ラ (B)		
C0034	US135100	CERAMIC CAPACITOR-F (CHIP)	0.1000 16V Z RECT.	チ ッ プ セ ラ (F)		
C0035	US062100	CERAMIC CAPACITOR-SL (CHIP)	100P 50V J RECT.	チ ッ プ セ ラ (S L)		
-45	US062100	CERAMIC CAPACITOR-SL (CHIP)	100P 50V J RECT.	チ ッ プ セ ラ (S L)		
C0046	US061330	CERAMIC CAPACITOR-CH (CHIP)	33P 50V J RECT.	チ ッ プ セ ラ (C H)		
C0047	US061330	CERAMIC CAPACITOR-CH (CHIP)	33P 50V J RECT.	チ ッ プ セ ラ (C H)		
CN004	VT388800	CONNECTOR BASE PIN	PH 7P TE	ベ ー ス 付 ポ ス ト		
CN005	WB24980R	TERMINAL	20P GPFA105-2002A0	中 継 タ ー ミ ナ ル		04
CN006	WE62140R	TERMINAL	10P GPFA105-1002A0	中 継 タ ー ミ ナ ル		02
D0001	VV92590R	DIODE	RLS-73 TE-11 TP	ダ イ オ ー ド		01
-6	VV92590R	DIODE	RLS-73 TE-11 TP	ダ イ オ ー ド		01
D0008	VV92590R	DIODE	RLS-73 TE-11 TP	ダ イ オ ー ド		01
IC002	X2538A00	IC	NJM2100V(TE2)	C	OP AMP	
IC005	X480120R	IC	HD6433693B14HV	C	E-VKS	05
L0002	V584810R	CHIP INDUCTANCE	56U ELJFC560JF	巻 線 チ ッ プ イ ン ダ ク タ		01
L0003	VR57990R	CHIP INDUCTANCE	BK2125 HS601-T	チ ッ プ イ ン ダ ク タ		01
L0004	VR57990R	CHIP INDUCTANCE	BK2125 HS601-T	チ ッ プ イ ン ダ ク タ		01
R0009	RD356100	CHIP RESISTOR 1/16W	1.0K 63M J RECT.	チ ッ プ 抵 抗		01
R0010	RD356100	CHIP RESISTOR 1/16W	1.0K 63M J RECT.	チ ッ プ 抵 抗		01

*: New Parts

RANK: Japan only

EMKS-FD(E-BUS)ON MKH-D and PNR/USB

REF NO.	PART NO.	DESCRIPTION		部 品 名	REMARKS	QTY	RANK
R0011	RD355150	CHIP RESISTOR 1/16W	150.0 63M J RECT.	チ ッ プ 抵 抗			
R0012	RD356680	CHIP RESISTOR 1/16W	6.8K 63M J RECT.	チ ッ プ 抵 抗			
R0013	RD355150	CHIP RESISTOR 1/16W	150.0 63M J RECT.	チ ッ プ 抵 抗			
R0014	RD356100	CHIP RESISTOR 1/16W	1.0K 63M J RECT.	チ ッ プ 抵 抗			01
R0015	RD355150	CHIP RESISTOR 1/16W	150.0 63M J RECT.	チ ッ プ 抵 抗			
R0016	RD357220	CHIP RESISTOR 1/16W	22.0K 63M J RECT.	チ ッ プ 抵 抗			01
R0017	RD35747R	CHIP RESISTOR 1/16W	47.0K 63M J RECT.	チ ッ プ 抵 抗			01
R0018	RD356100	CHIP RESISTOR 1/16W	1.0K 63M J RECT.	チ ッ プ 抵 抗			01
R0019	RD356100	CHIP RESISTOR 1/16W	1.0K 63M J RECT.	チ ッ プ 抵 抗			01
R0020	RD354470	CHIP RESISTOR 1/16W	47.0 63M J RECT.	チ ッ プ 抵 抗			
R0021	RD354470	CHIP RESISTOR 1/16W	47.0 63M J RECT.	チ ッ プ 抵 抗			
R0022	RD357100	CHIP RESISTOR 1/16W	10.0K 63M J RECT.	チ ッ プ 抵 抗			01
R0025	RD357100	CHIP RESISTOR 1/16W	10.0K 63M J RECT.	チ ッ プ 抵 抗			01
R0030	RD357330	CHIP RESISTOR 1/16W	33.0K 63M J RECT.	チ ッ プ 抵 抗			
-41	RD357330	CHIP RESISTOR 1/16W	33.0K 63M J RECT.	チ ッ プ 抵 抗			
R0043	RD356100	CHIP RESISTOR 1/16W	1.0K 63M J RECT.	チ ッ プ 抵 抗			01
R0046	RD354470	CHIP RESISTOR 1/16W	47.0 63M J RECT.	チ ッ プ 抵 抗			
R0047	RD354470	CHIP RESISTOR 1/16W	47.0 63M J RECT.	チ ッ プ 抵 抗			
VR001	VA788700	TRIMMER POTENTIOMETER	B 470.0K FUSE 3P R	半 固 定 V R	} GAIN adj.		01
VR001	WM950000	VR TRIMMER	B 470.0K FUSE 3P	半 固 定 V R			
VR002	VA78860R	TRIMMER POTENTIOMETER	B 330.0K FUSE 3P R	半 固 定 V R	} OFFSET adj.		01
VR002	WM949900	VR TRIMMER	B 330.0K FUSE 3P	半 固 定 V R			
X0001	V458460R	CERAMIC RESONATOR	20MHz CSTCV20M0X51J	セラミック振動子			01
* *	WK599200	CIRCUIT BOARD	PNR	P N R シ ー ト	(WM24240)(X9410C0)		
	WK611700	CIRCUIT BOARD	USB	U S B シ ー ト	(WM24240)(X9410C0)		
C1	US062470	CERAMIC CAPACITOR-SL (CHIP)	470P 50V J RECT.	チ ッ プ セ ラ (S L)			
-15	US062470	CERAMIC CAPACITOR-SL (CHIP)	470P 50V J RECT.	チ ッ プ セ ラ (S L)			
C16	US064100	CERAMIC CAPACITOR-B (CHIP)	0.0100 50V K RECT.	チ ッ プ セ ラ (B)			
C17	UF037100	ELECTROLYTIC CAP. (CHIP)	10 16V	チ ッ プ ケ ミ コ ン			
C18	US064100	CERAMIC CAPACITOR-B (CHIP)	0.0100 50V K RECT.	チ ッ プ セ ラ (B)			
C19	UF037100	ELECTROLYTIC CAP. (CHIP)	10 16V	チ ッ プ ケ ミ コ ン			
C20	US14510R	CERAMIC CAPACITOR-F (CHIP)	0.1000 25V Z RECT.	チ ッ プ セ ラ (F)			01
-23	US14510R	CERAMIC CAPACITOR-F (CHIP)	0.1000 25V Z RECT.	チ ッ プ セ ラ (F)			01
C24	US064100	CERAMIC CAPACITOR-B (CHIP)	0.0100 50V K RECT.	チ ッ プ セ ラ (B)			
C25	US14510R	CERAMIC CAPACITOR-F (CHIP)	0.1000 25V Z RECT.	チ ッ プ セ ラ (F)			01
C26	US064100	CERAMIC CAPACITOR-B (CHIP)	0.0100 50V K RECT.	チ ッ プ セ ラ (B)			
C27	UF037100	ELECTROLYTIC CAP. (CHIP)	10 16V	チ ッ プ ケ ミ コ ン			
C28	US14510R	CERAMIC CAPACITOR-F (CHIP)	0.1000 25V Z RECT.	チ ッ プ セ ラ (F)			01
C29	US14510R	CERAMIC CAPACITOR-F (CHIP)	0.1000 25V Z RECT.	チ ッ プ セ ラ (F)			01
C30	US064100	CERAMIC CAPACITOR-B (CHIP)	0.0100 50V K RECT.	チ ッ プ セ ラ (B)			
C31	US14510R	CERAMIC CAPACITOR-F (CHIP)	0.1000 25V Z RECT.	チ ッ プ セ ラ (F)			01
C32	US064100	CERAMIC CAPACITOR-B (CHIP)	0.0100 50V K RECT.	チ ッ プ セ ラ (B)			
C33	UF11822R	ELECTROLYTIC CAP. (CHIP)	220 6.3V	チ ッ プ ケ ミ コ ン			01
C34	US064100	CERAMIC CAPACITOR-B (CHIP)	0.0100 50V K RECT.	チ ッ プ セ ラ (B)			
C35	US061330	CERAMIC CAPACITOR-CH (CHIP)	33P 50V J RECT.	チ ッ プ セ ラ (C H)			
C36	US064100	CERAMIC CAPACITOR-B (CHIP)	0.0100 50V K RECT.	チ ッ プ セ ラ (B)			
C37	US14510R	CERAMIC CAPACITOR-F (CHIP)	0.1000 25V Z RECT.	チ ッ プ セ ラ (F)			01
C38	UF11822R	ELECTROLYTIC CAP. (CHIP)	220 6.3V	チ ッ プ ケ ミ コ ン			01
C39	US064100	CERAMIC CAPACITOR-B (CHIP)	0.0100 50V K RECT.	チ ッ プ セ ラ (B)			
C40	US061330	CERAMIC CAPACITOR-CH (CHIP)	33P 50V J RECT.	チ ッ プ セ ラ (C H)			
C41	US064100	CERAMIC CAPACITOR-B (CHIP)	0.0100 50V K RECT.	チ ッ プ セ ラ (B)			
C42	US14510R	CERAMIC CAPACITOR-F (CHIP)	0.1000 25V Z RECT.	チ ッ プ セ ラ (F)			01
C43	UF11822R	ELECTROLYTIC CAP. (CHIP)	220 6.3V	チ ッ プ ケ ミ コ ン			01
C44	US064100	CERAMIC CAPACITOR-B (CHIP)	0.0100 50V K RECT.	チ ッ プ セ ラ (B)			
C45	UF11822R	ELECTROLYTIC CAP. (CHIP)	220 6.3V	チ ッ プ ケ ミ コ ン			01
C46	US064100	CERAMIC CAPACITOR-B (CHIP)	0.0100 50V K RECT.	チ ッ プ セ ラ (B)			
C47	UF11822R	ELECTROLYTIC CAP. (CHIP)	220 6.3V	チ ッ プ ケ ミ コ ン			01
C48	US064100	CERAMIC CAPACITOR-B (CHIP)	0.0100 50V K RECT.	チ ッ プ セ ラ (B)			
C49	UF11822R	ELECTROLYTIC CAP. (CHIP)	220 6.3V	チ ッ プ ケ ミ コ ン			01
C50	US064100	CERAMIC CAPACITOR-B (CHIP)	0.0100 50V K RECT.	チ ッ プ セ ラ (B)			
C51	UF11822R	ELECTROLYTIC CAP. (CHIP)	220 6.3V	チ ッ プ ケ ミ コ ン			01
C52	US06168R	CERAMIC CAPACITOR-SL (CHIP)	68P 50V J RECT.	チ ッ プ セ ラ (S L)			01
C55	US14510R	CERAMIC CAPACITOR-F (CHIP)	0.1000 25V Z RECT.	チ ッ プ セ ラ (F)			01
C59	UF11822R	ELECTROLYTIC CAP. (CHIP)	220 6.3V	チ ッ プ ケ ミ コ ン			01
C61	US06168R	CERAMIC CAPACITOR-SL (CHIP)	68P 50V J RECT.	チ ッ プ セ ラ (S L)			01
C64	US14510R	CERAMIC CAPACITOR-F (CHIP)	0.1000 25V Z RECT.	チ ッ プ セ ラ (F)			01
C69	US14510R	CERAMIC CAPACITOR-F (CHIP)	0.1000 25V Z RECT.	チ ッ プ セ ラ (F)			01
C72	US14510R	CERAMIC CAPACITOR-F (CHIP)	0.1000 25V Z RECT.	チ ッ プ セ ラ (F)			01
C79	US06168R	CERAMIC CAPACITOR-SL (CHIP)	68P 50V J RECT.	チ ッ プ セ ラ (S L)			01

*: New Parts

RANK: Japan only

PNR/USB

REF NO.	PART NO.	DESCRIPTION		部 品 名	REMARKS	QTY	RANK
C80	US14510R	CERAMIC CAPACITOR-F (CHIP)	0.1000 25V Z RECT.	チップセラ(F)			01
C81	US061330	CERAMIC CAPACITOR-CH (CHIP)	33P 50V J RECT.	チップセラ(CH)			
C82	US061330	CERAMIC CAPACITOR-CH (CHIP)	33P 50V J RECT.	チップセラ(CH)			
C201	US14510R	CERAMIC CAPACITOR-F (CHIP)	0.1000 25V Z RECT.	チップセラ(F)			01
CN1	WA17860R	FFC CONNECTOR	52806-2210 22PIN	FFCコネクタ			01
CN2	VK015400	BASE POST CONNECTOR	PH 13P SE	ベースポスト			
CN4	VB858600	BASE PIN	PH 7P SE L-TYPE	ベースポスト			
CN201	VB858500	BASE PIN	PH 6P SE	ベースポスト			
CN202	WA245700	USB CONNECTOR	YKF45-0027 4P SE	USBコネクタ	USB TO DEVICE		02
D1	WG139300	DIODE	KDS4148U-RTK/P TE	ダイオード			
D2	WG139300	DIODE	KDS4148U-RTK/P TE	ダイオード			
D15	WG139300	DIODE	KDS4148U-RTK/P TE	ダイオード			
-81	WG139300	DIODE	KDS4148U-RTK/P TE	ダイオード			
EM201	WE94560R	EMI FILTER (CHIP)	NFM21CC223R1H3D	エミフィルチップ			01
IC1	XZ916300	IC	UPD780031AYGK-N09	IC	E-PNS2a LED/SWITCH DRIVER		
IC2	X5646200	IC	M34519M6-521FP	IC	LSC		04
IC3	X5646200	IC	M34519M6-521FP	IC	LSC		04
L1	GE300670	FERRIT BEAD	BL02RN2R1P1A TATET	フェライトビーズ			02
-4	GE300670	FERRIT BEAD	BL02RN2R1P1A TATET	フェライトビーズ			02
L201	VY65720R	CHIP INDUCTANCE	600 BK1608HM601-T	チップインダクタ			01
L202	WG834800	COIL	DLW21HN900SQ2L	コイル			
LD1	WF30100R	LED (CHIP) GREEN	SML-012PTT86A	チップLED	REGISTRATION MEMORY [1]		01
LD2	WF300900	LED (CHIP) ORANGE	SML-512DW	チップLED	REGISTRATION MEMORY [1]		01
LD3	WF30100R	LED (CHIP) GREEN	SML-012PTT86A	チップLED	REGISTRATION MEMORY [7]		01
LD4	WF300900	LED (CHIP) ORANGE	SML-512DW	チップLED	REGISTRATION MEMORY [7]		01
LD5	WF30100R	LED (CHIP) GREEN	SML-012PTT86A	チップLED	REGISTRATION MEMORY [2]		01
LD6	WF300900	LED (CHIP) ORANGE	SML-512DW	チップLED	REGISTRATION MEMORY [2]		01
LD7	WF30100R	LED (CHIP) GREEN	SML-012PTT86A	チップLED	REGISTRATION MEMORY [8]		01
LD8	WF300900	LED (CHIP) ORANGE	SML-512DW	チップLED	REGISTRATION MEMORY [8]		01
LD9	WK279100	LED (CHIP) WHITE	SMLE12WBC7W	チップLED	MUSIC FINDER		
* LD10	WN414500	LED	HFR8239P(P1D2)-BW	L E D	HARD DISK RECORDER [●]		
* LD11	WN414500	LED	HFR8239P(P1D2)-BW	L E D	REG. MEMORY [FREEZE]		
LD12	WF30100R	LED (CHIP) GREEN	SML-012PTT86A	チップLED	REGISTRATION MEMORY [3]		01
LD13	WF300900	LED (CHIP) ORANGE	SML-512DW	チップLED	REGISTRATION MEMORY [3]		01
* LD14	WM469900	LED GREEN	HFG223P-BW14	L E D	VOICE [PIANO]		
* LD15	WM469900	LED GREEN	HFG223P-BW14	L E D	VOICE [GUITAR]		
LD16	WF30100R	LED (CHIP) GREEN	SML-012PTT86A	チップLED	REGISTRATION MEMORY [4]		01
LD17	WF300900	LED (CHIP) ORANGE	SML-512DW	チップLED	REGISTRATION MEMORY [4]		01
* LD18	WM469900	LED GREEN	HFG223P-BW14	L E D	VOICE [E.PIANO]		
* LD19	WM469900	LED GREEN	HFG223P-BW14	L E D	VOICE [BASS]		
LD20	WF30100R	LED (CHIP) GREEN	SML-012PTT86A	チップLED	ONE TOUCH SETTING [1]		01
LD21	WF300900	LED (CHIP) ORANGE	SML-512DW	チップLED	ONE TOUCH SETTING [1]		01
LD22	WF30100R	LED (CHIP) GREEN	SML-012PTT86A	チップLED	REGISTRATION MEMORY [5]		01
LD23	WF300900	LED (CHIP) ORANGE	SML-512DW	チップLED	REGISTRATION MEMORY [5]		01
* LD24	WM469900	LED GREEN	HFG223P-BW14	L E D	VOICE [ORGAN]		
* LD25	WM469900	LED GREEN	HFG223P-BW14	L E D	VOICE [PERC./DRUM KIT]		
LD26	WF30100R	LED (CHIP) GREEN	SML-012PTT86A	チップLED	ONE TOUCH SETTING [2]		01
LD27	WF300900	LED (CHIP) ORANGE	SML-512DW	チップLED	ONE TOUCH SETTING [2]		01
LD28	WF30100R	LED (CHIP) GREEN	SML-012PTT86A	チップLED	REGISTRATION MEMORY [6]		01
LD29	WF300900	LED (CHIP) ORANGE	SML-512DW	チップLED	REGISTRATION MEMORY [6]		01
* LD30	WM469900	LED GREEN	HFG223P-BW14	L E D	READ/WRITE		
* LD31	WM469900	LED GREEN	HFG223P-BW14	L E D	VOICE EFFECT [HARMONY/ECHO]		
* LD32	WM469900	LED GREEN	HFG223P-BW14	L E D	VOICE [STRINGS]		
* LD33	WM469900	LED GREEN	HFG223P-BW14	L E D	VOICE [ACCORDION]		
LD34	WF30100R	LED (CHIP) GREEN	SML-012PTT86A	チップLED	ONE TOUCH SETTING [3]		01
LD35	WF300900	LED (CHIP) ORANGE	SML-512DW	チップLED	ONE TOUCH SETTING [3]		01
* LD36	WM469900	LED GREEN	HFG223P-BW14	L E D	VOICE EFFECT [INITIAL TOUCH]		
* LD37	WM469900	LED GREEN	HFG223P-BW14	L E D	VOICE [CHOIR]		
* LD38	WM469900	LED GREEN	HFG223P-BW14	L E D	VOICE [PAD]		
LD39	WF30100R	LED (CHIP) GREEN	SML-012PTT86A	チップLED	ONE TOUCH SETTING [4]		01
LD40	WF300900	LED (CHIP) ORANGE	SML-512DW	チップLED	ONE TOUCH SETTING [4]		01
* LD41	WM470100	LED AMBER	HFY123P-BW14	L E D	HARD DISK RECORDER [▶/■]		
* LD42	WM469900	LED GREEN	HFG223P-BW14	L E D	PART ON/OFF [LEFT HOLD]		
* LD43	WM469900	LED GREEN	HFG223P-BW14	L E D	VOICE EFFECT [SUSTAIN]		
* LD44	WM469900	LED GREEN	HFG223P-BW14	L E D	VOICE [BRASS]		
* LD45	WM469900	LED GREEN	HFG223P-BW14	L E D	VOICE [SYNTH]		
LD46	WF30100R	LED (CHIP) GREEN	SML-012PTT86A	チップLED	PART SELECT [LEFT]		01
LD47	WF300900	LED (CHIP) ORANGE	SML-512DW	チップLED	PART ON/OFF [LEFT]		01
* LD48	WM469900	LED GREEN	HFG223P-BW14	L E D	VOICE EFFECT [MONO]		
* LD49	WM469900	LED GREEN	HFG223P-BW14	L E D	VOICE [TRUMPET]		

*: New Parts

RANK: Japan only

PNR/USB

REF NO.	PART NO.	DESCRIPTION		部	品	名	REMARKS	QTY	RANK
* LD50	WM469900	LED GREEN	HFG223P-BW14	L	E	D	VOICE [ORGAN FLUTES]		
LD51	WF30100R	LED (CHIP) GREEN	SML-012PTT86A	チ	ッ	ブ L E D	PART SELECT [RIGHT 1]		01
LD52	WF300900	LED (CHIP) ORANGE	SML-512DW	チ	ッ	ブ L E D	PART ON/OFF [RIGHT 1]		01
LD53	WM469900	LED GREEN	HFG223P-BW14	L	E	D	VOICE EFFECT [DSP]		
* LD54	WM469900	LED GREEN	HFG223P-BW14	L	E	D	VOICE [SAXOPHONE]		
* LD55	WM469900	LED GREEN	HFG223P-BW14	L	E	D	VOICE [EXPANSION]		
LD56	WF30100R	LED (CHIP) GREEN	SML-012PTT86A	チ	ッ	ブ L E D	PART SELECT [RIGHT 2]		01
LD57	WF300900	LED (CHIP) ORANGE	SML-512DW	チ	ッ	ブ L E D	PART ON/OFF [RIGHT 2]		01
* LD58	WM469900	LED GREEN	HFG223P-BW14	L	E	D	VOICE EFFECT [VARIATION]		
* LD59	WM469900	LED GREEN	HFG223P-BW14	L	E	D	VOICE [FLUTE/CLARINET]		
* LD60	WM469900	LED GREEN	HFG223P-BW14	L	E	D	VOICE [USER DRIVE]		
LD61	WF30100R	LED (CHIP) GREEN	SML-012PTT86A	チ	ッ	ブ L E D	PART SELECT [RIGHT 3]		01
LD62	WF300900	LED (CHIP) ORANGE	SML-512DW	チ	ッ	ブ L E D	PART ON/OFF [RIGHT 3]		01
R13	RD357100	CHIP RESISTOR 1/16W	10.0K 63M J RECT.	チ	ッ	ブ 抵 抗			01
-24	RD357100	CHIP RESISTOR 1/16W	10.0K 63M J RECT.	チ	ッ	ブ 抵 抗			01
R28	RD357100	CHIP RESISTOR 1/16W	10.0K 63M J RECT.	チ	ッ	ブ 抵 抗			01
-35	RD357100	CHIP RESISTOR 1/16W	10.0K 63M J RECT.	チ	ッ	ブ 抵 抗			01
R36	RD350001	CHIP RESISTOR 1/16W	0 63M J RECT.	チ	ッ	ブ 抵 抗			01
R37	RD356100	CHIP RESISTOR 1/16W	1.0K 63M J RECT.	チ	ッ	ブ 抵 抗			01
-45	RD356100	CHIP RESISTOR 1/16W	1.0K 63M J RECT.	チ	ッ	ブ 抵 抗			01
R46	RD35433R	CHIP RESISTOR 1/16W	33.0 63M J RECT.	チ	ッ	ブ 抵 抗			01
-51	RD35433R	CHIP RESISTOR 1/16W	33.0 63M J RECT.	チ	ッ	ブ 抵 抗			01
R52	RD357100	CHIP RESISTOR 1/16W	10.0K 63M J RECT.	チ	ッ	ブ 抵 抗			01
-66	RD357100	CHIP RESISTOR 1/16W	10.0K 63M J RECT.	チ	ッ	ブ 抵 抗			01
R67	RD356100	CHIP RESISTOR 1/16W	1.0K 63M J RECT.	チ	ッ	ブ 抵 抗			01
R68	RD356680	CHIP RESISTOR 1/16W	6.8K 63M J RECT.	チ	ッ	ブ 抵 抗			01
R69	RD357100	CHIP RESISTOR 1/16W	10.0K 63M J RECT.	チ	ッ	ブ 抵 抗			01
-79	RD357100	CHIP RESISTOR 1/16W	10.0K 63M J RECT.	チ	ッ	ブ 抵 抗			01
R80	RD354680	CHIP RESISTOR 1/16W	68.0 63M J RECT.	チ	ッ	ブ 抵 抗			01
-83	RD354680	CHIP RESISTOR 1/16W	68.0 63M J RECT.	チ	ッ	ブ 抵 抗			01
R84	RD357100	CHIP RESISTOR 1/16W	10.0K 63M J RECT.	チ	ッ	ブ 抵 抗			01
-96	RD357100	CHIP RESISTOR 1/16W	10.0K 63M J RECT.	チ	ッ	ブ 抵 抗			01
R97	RD356100	CHIP RESISTOR 1/16W	1.0K 63M J RECT.	チ	ッ	ブ 抵 抗			01
R98	RD356680	CHIP RESISTOR 1/16W	6.8K 63M J RECT.	チ	ッ	ブ 抵 抗			01
R99	RD357100	CHIP RESISTOR 1/16W	10.0K 63M J RECT.	チ	ッ	ブ 抵 抗			01
-105	RD357100	CHIP RESISTOR 1/16W	10.0K 63M J RECT.	チ	ッ	ブ 抵 抗			01
R106	RD354680	CHIP RESISTOR 1/16W	68.0 63M J RECT.	チ	ッ	ブ 抵 抗			01
-109	RD354680	CHIP RESISTOR 1/16W	68.0 63M J RECT.	チ	ッ	ブ 抵 抗			01
R110	RD357100	CHIP RESISTOR 1/16W	10.0K 63M J RECT.	チ	ッ	ブ 抵 抗			01
-114	RD357100	CHIP RESISTOR 1/16W	10.0K 63M J RECT.	チ	ッ	ブ 抵 抗			01
R115	RD354680	CHIP RESISTOR 1/16W	68.0 63M J RECT.	チ	ッ	ブ 抵 抗			01
R116	RD355390	CHIP RESISTOR 1/16W	390.0 63M J RECT.	チ	ッ	ブ 抵 抗			01
R117	RD354680	CHIP RESISTOR 1/16W	68.0 63M J RECT.	チ	ッ	ブ 抵 抗			01
R118	RD355390	CHIP RESISTOR 1/16W	390.0 63M J RECT.	チ	ッ	ブ 抵 抗			01
R119	RD354680	CHIP RESISTOR 1/16W	68.0 63M J RECT.	チ	ッ	ブ 抵 抗			01
R120	RD355390	CHIP RESISTOR 1/16W	390.0 63M J RECT.	チ	ッ	ブ 抵 抗			01
R121	RD354680	CHIP RESISTOR 1/16W	68.0 63M J RECT.	チ	ッ	ブ 抵 抗			01
R122	RD355390	CHIP RESISTOR 1/16W	390.0 63M J RECT.	チ	ッ	ブ 抵 抗			01
R123	RD354680	CHIP RESISTOR 1/16W	68.0 63M J RECT.	チ	ッ	ブ 抵 抗			01
R124	RD355390	CHIP RESISTOR 1/16W	390.0 63M J RECT.	チ	ッ	ブ 抵 抗			01
R125	RD354680	CHIP RESISTOR 1/16W	68.0 63M J RECT.	チ	ッ	ブ 抵 抗			01
R126	RD355390	CHIP RESISTOR 1/16W	390.0 63M J RECT.	チ	ッ	ブ 抵 抗			01
R127	RD354680	CHIP RESISTOR 1/16W	68.0 63M J RECT.	チ	ッ	ブ 抵 抗			01
R128	RD355390	CHIP RESISTOR 1/16W	390.0 63M J RECT.	チ	ッ	ブ 抵 抗			01
R129	RD354680	CHIP RESISTOR 1/16W	68.0 63M J RECT.	チ	ッ	ブ 抵 抗			01
R130	RD355390	CHIP RESISTOR 1/16W	390.0 63M J RECT.	チ	ッ	ブ 抵 抗			01
R131	RD354680	CHIP RESISTOR 1/16W	68.0 63M J RECT.	チ	ッ	ブ 抵 抗			01
R132	RD355390	CHIP RESISTOR 1/16W	390.0 63M J RECT.	チ	ッ	ブ 抵 抗			01
R133	RD354680	CHIP RESISTOR 1/16W	68.0 63M J RECT.	チ	ッ	ブ 抵 抗			01
R134	RD355390	CHIP RESISTOR 1/16W	390.0 63M J RECT.	チ	ッ	ブ 抵 抗			01
R135	RD354680	CHIP RESISTOR 1/16W	68.0 63M J RECT.	チ	ッ	ブ 抵 抗			01
R136	RD355390	CHIP RESISTOR 1/16W	390.0 63M J RECT.	チ	ッ	ブ 抵 抗			01
R137	RD354680	CHIP RESISTOR 1/16W	68.0 63M J RECT.	チ	ッ	ブ 抵 抗			01
R138	RD355390	CHIP RESISTOR 1/16W	390.0 63M J RECT.	チ	ッ	ブ 抵 抗			01
R139	RD354680	CHIP RESISTOR 1/16W	68.0 63M J RECT.	チ	ッ	ブ 抵 抗			01
R140	RD355390	CHIP RESISTOR 1/16W	390.0 63M J RECT.	チ	ッ	ブ 抵 抗			01
R141	RD354680	CHIP RESISTOR 1/16W	68.0 63M J RECT.	チ	ッ	ブ 抵 抗			01
R142	RD355390	CHIP RESISTOR 1/16W	390.0 63M J RECT.	チ	ッ	ブ 抵 抗			01
R143	RD354680	CHIP RESISTOR 1/16W	68.0 63M J RECT.	チ	ッ	ブ 抵 抗			01
R144	RD355390	CHIP RESISTOR 1/16W	390.0 63M J RECT.	チ	ッ	ブ 抵 抗			01

*: New Parts

RANK: Japan only

PNR/USB

REF NO.	PART NO.	DESCRIPTION		部	品	名	REMARKS	QTY	RANK
R145	RD354680	CHIP RESISTOR 1/16W	68.0 63M J RECT.	チ	ッ	ブ 抵 抗			
R146	RD355390	CHIP RESISTOR 1/16W	390.0 63M J RECT.	チ	ッ	ブ 抵 抗			
R147	RD355330	CHIP RESISTOR 1/16W	330.0 63M J RECT.	チ	ッ	ブ 抵 抗			
R148	RD355330	CHIP RESISTOR 1/16W	330.0 63M J RECT.	チ	ッ	ブ 抵 抗			
R149	RD355150	CHIP RESISTOR 1/16W	150.0 63M J RECT.	チ	ッ	ブ 抵 抗			
R150	RD35415R	CHIP RESISTOR 1/16W	15.0 63M J RECT.	チ	ッ	ブ 抵 抗			01
R155	RD355220	CHIP RESISTOR 1/16W	220.0 63M J RECT.	チ	ッ	ブ 抵 抗			
R156	RD355100	CHIP RESISTOR 1/16W	100.0 63M J RECT.	チ	ッ	ブ 抵 抗			
-159	RD355100	CHIP RESISTOR 1/16W	100.0 63M J RECT.	チ	ッ	ブ 抵 抗			
R160	RD350001	CHIP RESISTOR 1/16W	0 63M J RECT.	チ	ッ	ブ 抵 抗			01
-172	RD350001	CHIP RESISTOR 1/16W	0 63M J RECT.	チ	ッ	ブ 抵 抗			01
R173	RD354470	CHIP RESISTOR 1/16W	47.0 63M J RECT.	チ	ッ	ブ 抵 抗			
R174	RD355120	CHIP RESISTOR 1/16W	120.0 63M J RECT.	チ	ッ	ブ 抵 抗			01
R175	RD355120	CHIP RESISTOR 1/16W	120.0 63M J RECT.	チ	ッ	ブ 抵 抗			01
R176	RD35410R	CHIP RESISTOR 1/16W	10.0 63M J RECT.	チ	ッ	ブ 抵 抗			01
R177	RD35410R	CHIP RESISTOR 1/16W	10.0 63M J RECT.	チ	ッ	ブ 抵 抗			01
R178	RD350001	CHIP RESISTOR 1/16W	0 63M J RECT.	チ	ッ	ブ 抵 抗			01
-180	RD350001	CHIP RESISTOR 1/16W	0 63M J RECT.	チ	ッ	ブ 抵 抗			01
R181	RD355150	CHIP RESISTOR 1/16W	150.0 63M J RECT.	チ	ッ	ブ 抵 抗			
-185	RD355150	CHIP RESISTOR 1/16W	150.0 63M J RECT.	チ	ッ	ブ 抵 抗			
R186	RD354680	CHIP RESISTOR 1/16W	68.0 63M J RECT.	チ	ッ	ブ 抵 抗			
R187	RD354680	CHIP RESISTOR 1/16W	68.0 63M J RECT.	チ	ッ	ブ 抵 抗			
SW1	WG31840R	TACT SWITCH	SKRGAMD010	タ	ク	ト S W	MENU [VOICE CREATOR]		01
SW2	WG31840R	TACT SWITCH	SKRGAMD010	タ	ク	ト S W	MENU [FUNCTION]		01
SW3	WG31840R	TACT SWITCH	SKRGAMD010	タ	ク	ト S W	REGIST BANK [-]		01
SW4	WG31840R	TACT SWITCH	SKRGAMD010	タ	ク	ト S W	REGISTRATION MEMORY [1]		01
SW5	WG31840R	TACT SWITCH	SKRGAMD010	タ	ク	ト S W	REGISTRATION MEMORY [7]		01
SW6	WG31840R	TACT SWITCH	SKRGAMD010	タ	ク	ト S W	MENU [DIGITAL RECORDING]		01
SW7	WG31840R	TACT SWITCH	SKRGAMD010	タ	ク	ト S W	INTERNET		01
SW8	WG31840R	TACT SWITCH	SKRGAMD010	タ	ク	ト S W	REGIST BANK [+]		01
SW9	WG31840R	TACT SWITCH	SKRGAMD010	タ	ク	ト S W	REGISTRATION MEMORY [2]		01
SW10	WG31840R	TACT SWITCH	SKRGAMD010	タ	ク	ト S W	REGISTRATION MEMORY [8]		01
SW11	WG31840R	TACT SWITCH	SKRGAMD010	タ	ク	ト S W	HARD DISK RECORDER [●]		01
SW12	WG31840R	TACT SWITCH	SKRGAMD010	タ	ク	ト S W	MUSIC FINDER		01
SW13	WG31840R	TACT SWITCH	SKRGAMD010	タ	ク	ト S W	REG. MEMORY [FREEZE]		01
SW14	WG31840R	TACT SWITCH	SKRGAMD010	タ	ク	ト S W	REGISTRATION MEMORY [3]		01
SW15	WG31840R	TACT SWITCH	SKRGAMD010	タ	ク	ト S W	VOICE [PIANO]		01
SW16	WG31840R	TACT SWITCH	SKRGAMD010	タ	ク	ト S W	VOICE [GUITAR]		01
SW17	WG31840R	TACT SWITCH	SKRGAMD010	タ	ク	ト S W	REGISTRATION MEMORY [4]		01
SW18	WG31840R	TACT SWITCH	SKRGAMD010	タ	ク	ト S W	REG. MEMORY [MEMORY]		01
SW19	WG31840R	TACT SWITCH	SKRGAMD010	タ	ク	ト S W	VOICE [E.PIANO]		01
SW20	WG31840R	TACT SWITCH	SKRGAMD010	タ	ク	ト S W	VOICE [BASS]		01
SW21	WG31840R	TACT SWITCH	SKRGAMD010	タ	ク	ト S W	ONE TOUCH SETTING [1]		01
SW22	WG31840R	TACT SWITCH	SKRGAMD010	タ	ク	ト S W	REGISTRATION MEMORY [5]		01
SW23	WG31840R	TACT SWITCH	SKRGAMD010	タ	ク	ト S W	VOICE [ORGAN]		01
SW24	WG31840R	TACT SWITCH	SKRGAMD010	タ	ク	ト S W	VOICE [PERC./DRUM KIT]		01
SW25	WG31840R	TACT SWITCH	SKRGAMD010	タ	ク	ト S W	ONE TOUCH SETTING [2]		01
SW26	WG31840R	TACT SWITCH	SKRGAMD010	タ	ク	ト S W	REGISTRATION MEMORY [6]		01
SW27	WG31840R	TACT SWITCH	SKRGAMD010	タ	ク	ト S W	VOICE EFFECT [HARMONY/ECHO]		01
SW28	WG31840R	TACT SWITCH	SKRGAMD010	タ	ク	ト S W	VOICE [STRINGS]		01
SW29	WG31840R	TACT SWITCH	SKRGAMD010	タ	ク	ト S W	VOICE [ACCORDION]		01
SW30	WG31840R	TACT SWITCH	SKRGAMD010	タ	ク	ト S W	ONE TOUCH SETTING [3]		01
SW31	WG31840R	TACT SWITCH	SKRGAMD010	タ	ク	ト S W	HARD DISK RECORDER [◀◀]		01
SW32	WG31840R	TACT SWITCH	SKRGAMD010	タ	ク	ト S W	VOICE EFFECT [INITIAL TOUCH]		01
SW33	WG31840R	TACT SWITCH	SKRGAMD010	タ	ク	ト S W	VOICE [CHOIR]		01
SW34	WG31840R	TACT SWITCH	SKRGAMD010	タ	ク	ト S W	VOICE [PAD]		01
SW35	WG31840R	TACT SWITCH	SKRGAMD010	タ	ク	ト S W	ONE TOUCH SETTING [4]		01
SW36	WG31840R	TACT SWITCH	SKRGAMD010	タ	ク	ト S W	PART ON/OFF [LEFT HOLD]		01
SW37	WG31840R	TACT SWITCH	SKRGAMD010	タ	ク	ト S W	HARD DISK RECORDER [▶/■]		01
SW38	WG31840R	TACT SWITCH	SKRGAMD010	タ	ク	ト S W	VOICE EFFECT [SUSTAIN]		01
SW39	WG31840R	TACT SWITCH	SKRGAMD010	タ	ク	ト S W	VOICE [BRASS]		01
SW40	WG31840R	TACT SWITCH	SKRGAMD010	タ	ク	ト S W	VOICE [SYNTH]		01
SW41	WG31840R	TACT SWITCH	SKRGAMD010	タ	ク	ト S W	PART SELECT [LEFT]		01
SW42	WG31840R	TACT SWITCH	SKRGAMD010	タ	ク	ト S W	PART ON/OFF [LEFT]		01
SW43	WG31840R	TACT SWITCH	SKRGAMD010	タ	ク	ト S W	HARD DISK RECORDER [■]		01
SW44	WG31840R	TACT SWITCH	SKRGAMD010	タ	ク	ト S W	VOICE EFFECT [MONO]		01
SW45	WG31840R	TACT SWITCH	SKRGAMD010	タ	ク	ト S W	VOICE [TRUMPET]		01
SW46	WG31840R	TACT SWITCH	SKRGAMD010	タ	ク	ト S W	VOICE [ORGAN FLUTES]		01
SW47	WG31840R	TACT SWITCH	SKRGAMD010	タ	ク	ト S W	PART SELECT [RIGHT 1]		01
SW48	WG31840R	TACT SWITCH	SKRGAMD010	タ	ク	ト S W	PART ON/OFF [RIGHT 1]		01

*: New Parts

RANK: Japan only

PNR/USB

REF NO.	PART NO.	DESCRIPTION		部 品 名	REMARKS	QTY	RANK
SW49	WG31840R	TACT SWITCH	SKRGAMD010	タ ク ト S W	HARD DISK RECORDER [▶▶]		01
SW50	WG31840R	TACT SWITCH	SKRGAMD010	タ ク ト S W	VOICE EFFECT [DSP]		01
SW51	WG31840R	TACT SWITCH	SKRGAMD010	タ ク ト S W	VOICE [SAXOPHONE]		01
SW52	WG31840R	TACT SWITCH	SKRGAMD010	タ ク ト S W	VOICE [EXPANSION]		01
SW53	WG31840R	TACT SWITCH	SKRGAMD010	タ ク ト S W	PART SELECT [RIGHT 2]		01
SW54	WG31840R	TACT SWITCH	SKRGAMD010	タ ク ト S W	PART ON/OFF [RIGHT 2]		01
SW55	WG31840R	TACT SWITCH	SKRGAMD010	タ ク ト S W	HARD DISK RECORDER [SELECT]		01
SW56	WG31840R	TACT SWITCH	SKRGAMD010	タ ク ト S W	VOICE EFFECT [VARIATION]		01
SW57	WG31840R	TACT SWITCH	SKRGAMD010	タ ク ト S W	VOICE [FLUTE/CLARINET]		01
SW58	WG31840R	TACT SWITCH	SKRGAMD010	タ ク ト S W	VOICE [USER DRIVE]		01
SW59	WG31840R	TACT SWITCH	SKRGAMD010	タ ク ト S W	PART SELECT [RIGHT 3]		01
SW60	WG31840R	TACT SWITCH	SKRGAMD010	タ ク ト S W	PART ON/OFF [RIGHT 3]		01
SW61	WG31840R	TACT SWITCH	SKRGAMD010	タ ク ト S W	HARD DISK RECORDER [SETTING]		01
TA1	V856660R	TRANSISTOR ARRAY	TD62785FG-(5,EL)	ト ラ ン ジ ス タ ア レ イ			05
TA2	WC71000R	TRANSISTOR ARRAY	M54562FP-DB1J	ト ラ ン ジ ス タ ア レ イ			
-5	WC71000R	TRANSISTOR ARRAY	M54562FP-DB1J	ト ラ ン ジ ス タ ア レ イ			
TR1	WA01310R	DIGITAL TRANSISTOR	DTDG23YP T100	デ ジ タ ル ト ラ ン ジ ス タ			01
-6	WA01310R	DIGITAL TRANSISTOR	DTDG23YP T100	デ ジ タ ル ト ラ ン ジ ス タ			01
TR7	VY67760R	DIGITAL TRANSISTOR	DTC123JKA TP	デ ジ タ ル ト ラ ン ジ ス タ			01
* X1	WM775700	CERAMIC RESONATOR	8.38MHz CSTCE8M38G55	セ ラ ミ ッ ク 振 動 子			
*	WP376100	HARD DISK DRIVE UNIT	2.5 inch 80GB	ハ ー ド デ ィ ス ク			
*	WN675600	CRYSTAL DISPLAY	LTA075A363F	液 晶 デ ィ ス プ レ イ			
	VT69510R	ROTARY VARIABLE RESISTOR	SP. 10.0K RK163111	ロ ー タ リ ー V R	PITCH BEND,MODULATION	2	03
⚠	WB50130R	POWER SUPPLY UNIT	CE,U,CS	電 源 ユ ニ ッ ト			
⚠	WA78260R	AC-IN CONNECTOR ACINLET	R-301(B18)	A C イ ン レ ッ ト	AC IN		02
⚠	VP18400R	PUSH SWITCH	SDDL13600	プ ッ シ ュ S W	POWER ON/OFF		03

*: New Parts

RANK: Japan only

TRS-MS02

PARTS LIST


■ CONTENTS

OVERALL ASSEMBLY	2
------------------------	---

Notes : DESTINATION ABBREVIATIONS

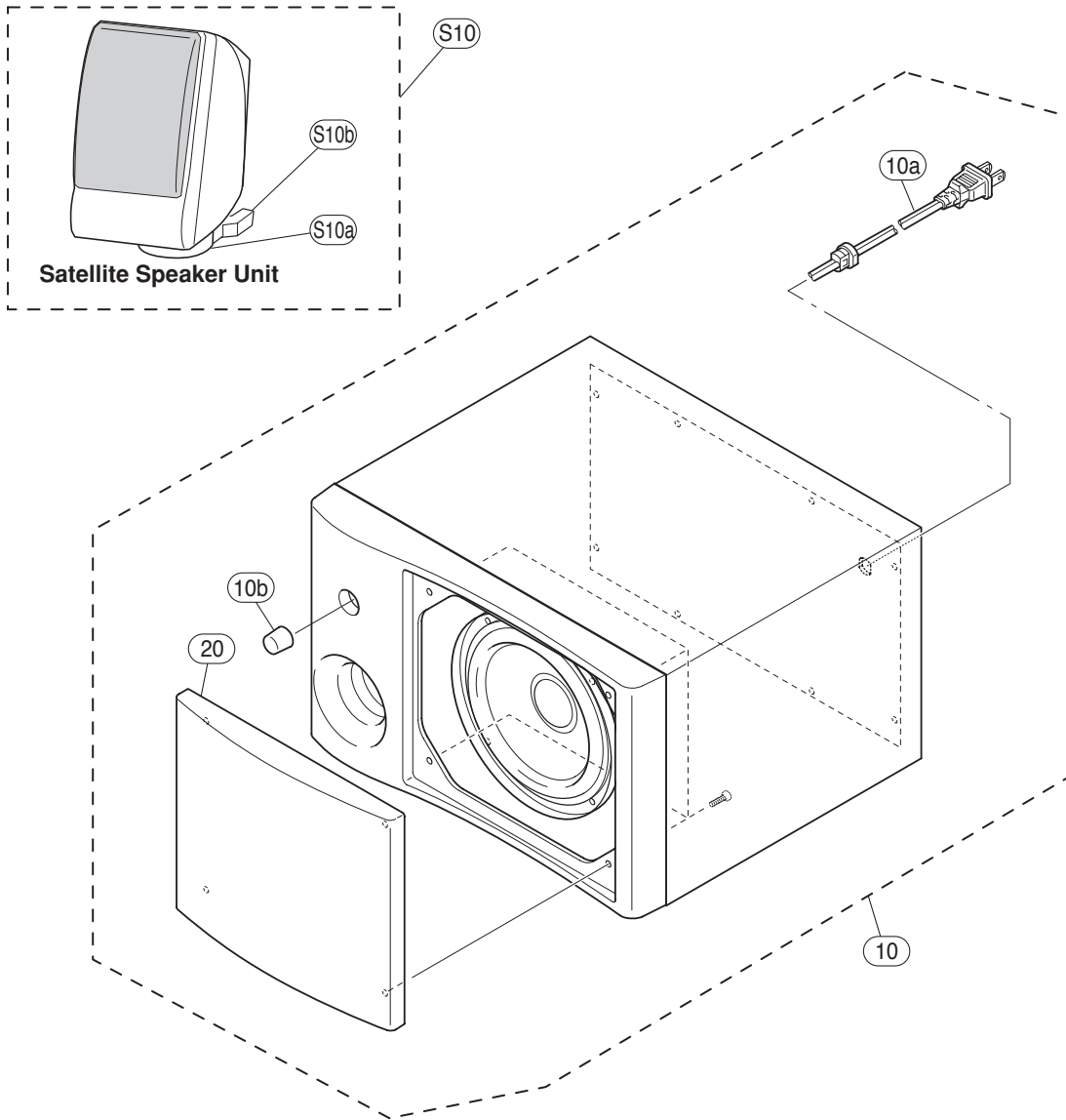
A : Australian model	M : South African model
B : British model	O : Chinese model
C : Canadian model	Q : South-east Asia model
D : German model	T : Taiwan model
E : European model	U : U.S.A. model
F : French model	V : General export model (110V)
H : North European model	W : General export model (220V)
I : Indonesian model	N,X: General export model
J : Japanese model	Y : Export model
K : Korean model	

■ WARNING

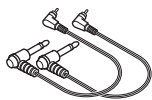
Components having special characteristics are marked  and must be replaced with parts having specification equal to those originally installed.

- The numbers "QTY" show quantities for each unit.
- The parts with "--" in "PART NO." are not available as spare parts.
- This mark "}" in the REMARKS column means these parts are interchangeable.
- The second letter of the shaded (■) part number is O, not zero.
- The second letter of the shaded (■) part number is I, not one.

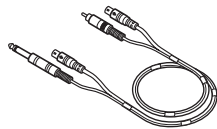
OVERALL ASSEMBLY



ACCESSORIES



Speaker Cable
(RCA pin cables)



Woofer Cable
(RCA pin/8-pin
combination cable)



Speaker Stand Assembly
(Speaker brackets)

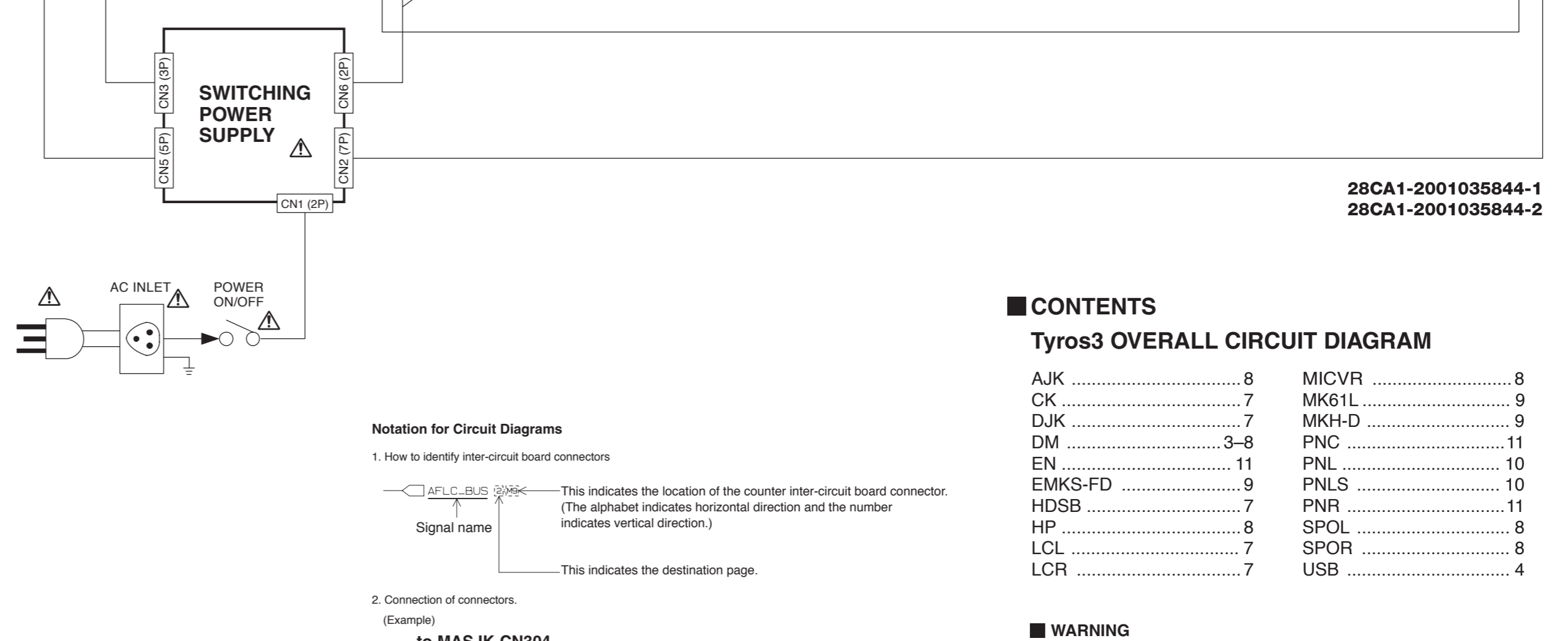
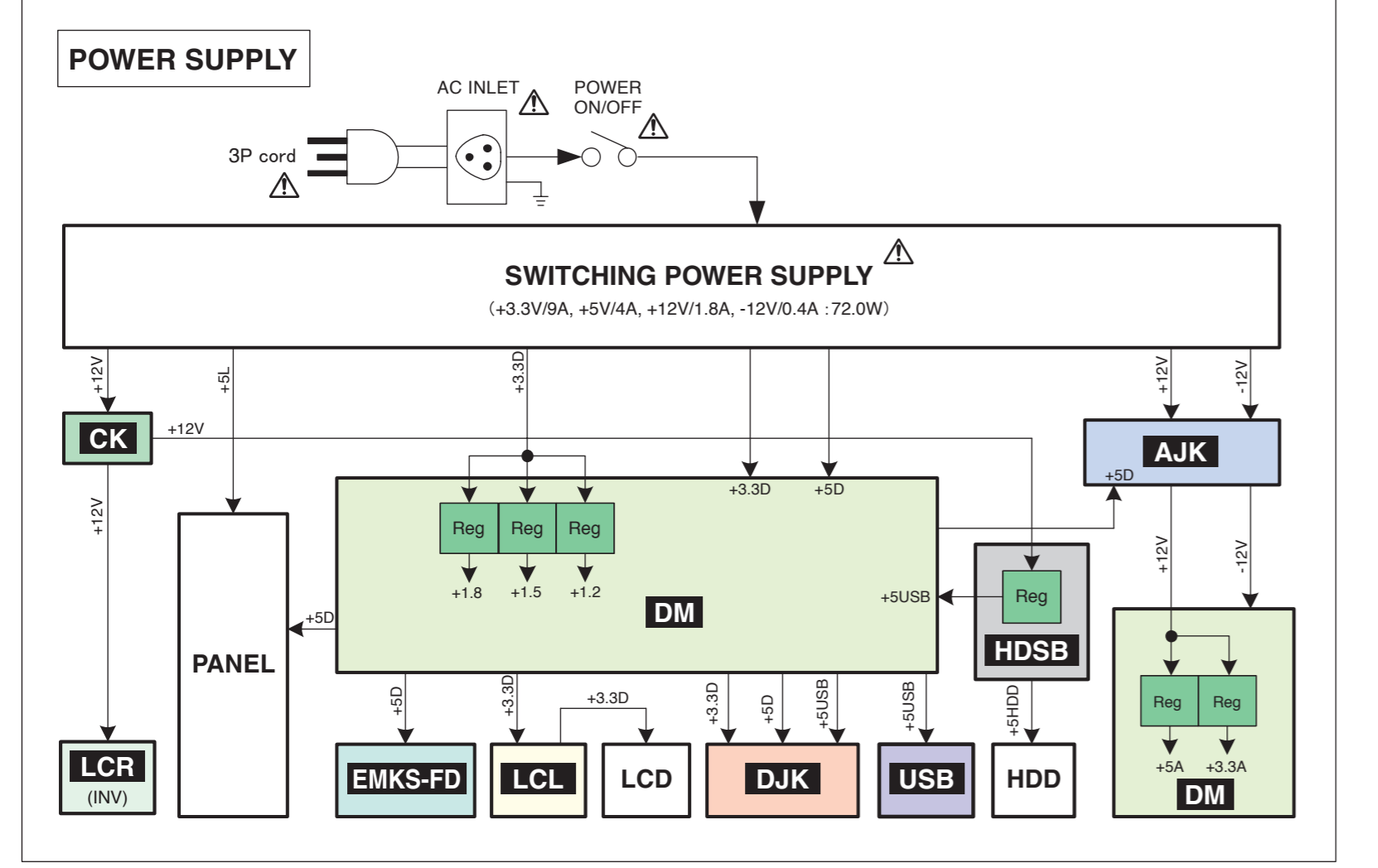
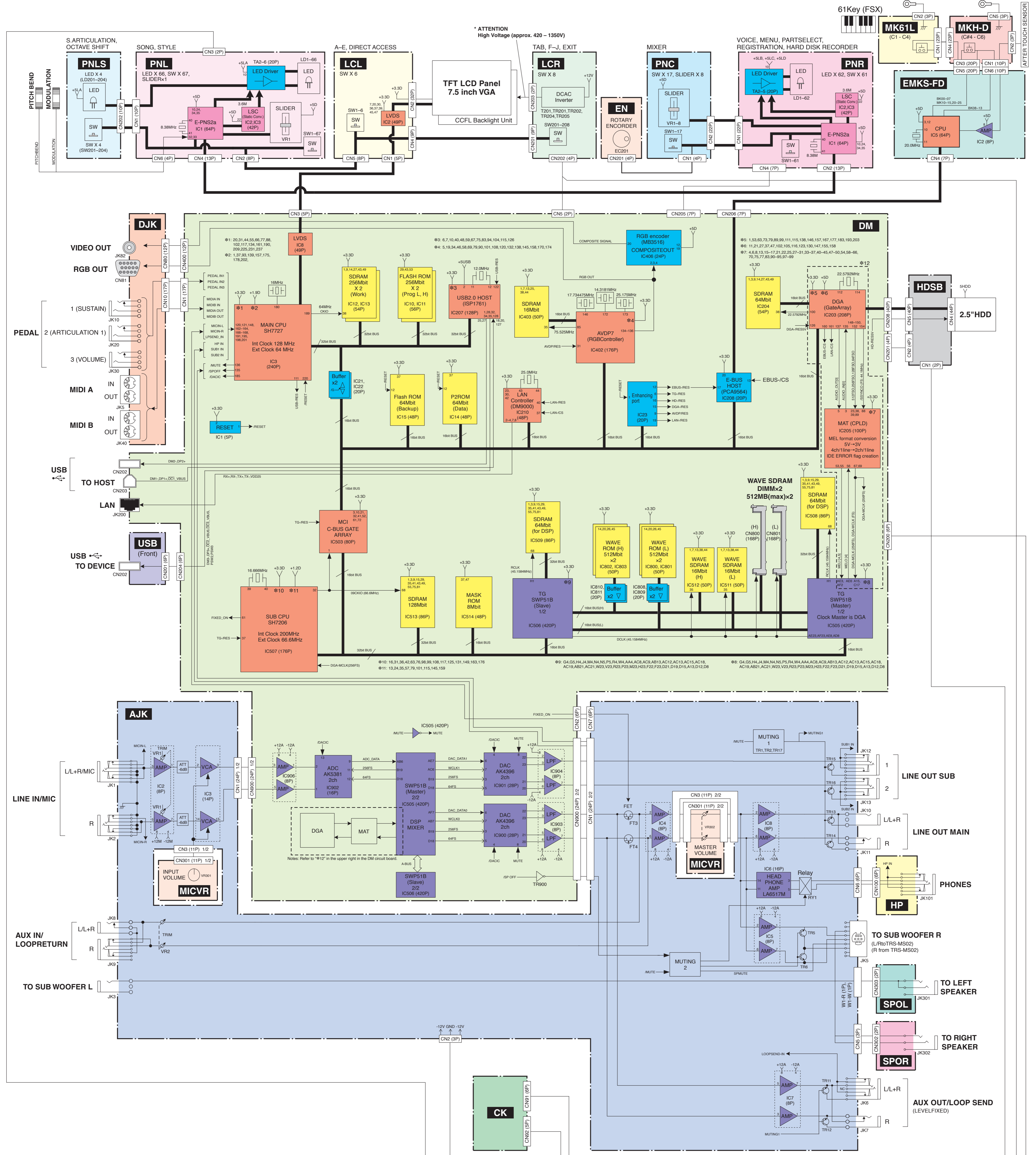
REF NO.	PART NO.	DESCRIPTION	部 品 名	REMARKS	QTY	RANK
		WOOFER SPEAKER SYSTEM		ウーファースピーカシステム		
10	WF886600	WOOFER UNIT E		ウーファーユニット	E	
10	WF886700	WOOFER UNIT U		ウーファーユニット	U	
10	WF886800	WOOFER UNIT B		ウーファーユニット	B	
10	WF886900	WOOFER UNIT A		ウーファーユニット	A	
10a	V8366400	POWER CORD	PHP-205 LF	電源コード	E	04
10a	V8366300	POWER CORD		電源コード	U	04
10a	WF886300	POWER CORD	PHP-330 2 LF	電源コード	B	
10a	WF886400	POWER CORD	PHP-208 2 LF	電源コード	A	
10b	WF887500	KNOB VR		ノブ	BASS	
20	WG033100	GRILLE ASSEMBLY		グリル As s y		
S10	WF887000	SATELLITE SPEAKER		サテライトスピーカ		2
S10a	WF887300	TABLE		テーブル		2
S10b	WF887400	LEVER		レバ		2
		ACCESSORIES		付属品		
	WF887200	WOOFER CABLE	RCA pin/8-pin L=1885	ウーファーケーブル		
	WF887100	SPEAKER CABLE	RCA	スピーカケーブル		2
	WF237400	SPEAKER STAND ASSEMBLY		スピーカスタンド As s y		2



*: New Parts

RANK: Japan only

Tyros3 BLOCK DIAGRAM



CONTENTS

Tyros3 OVERALL CIRCUIT DIAGRAM

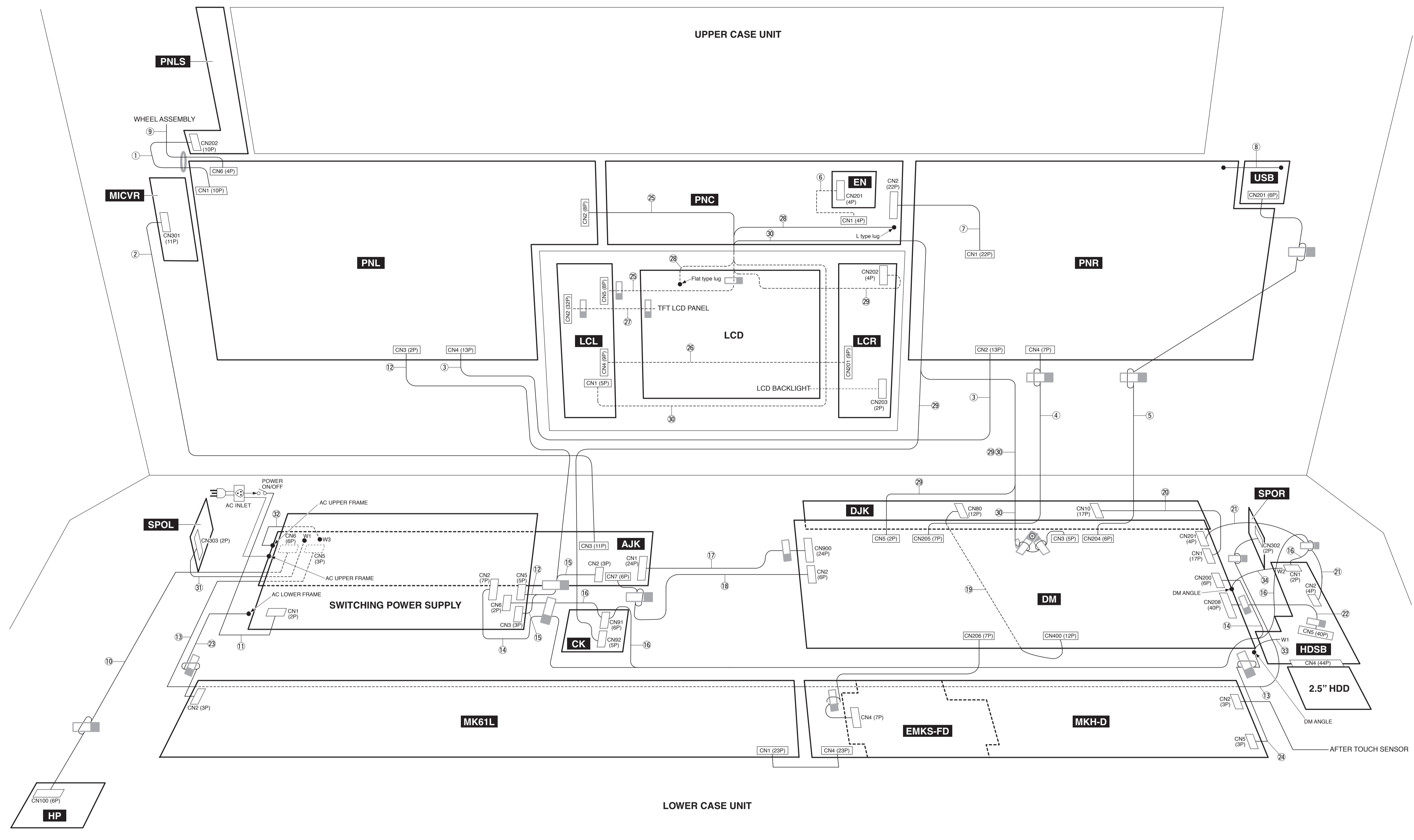
AJK	8	MICVR	8
CK	7	MK61L	9
DJK	7	MKH-D	9
DM	3-8	PNC	11
EN	11	PNL	10
EMKS-FD	9	PNLS	10
HDSB	7	PNR	11
HP	8	SPOL	8
LCL	8	SPOR	8
LCR	7	USB	4

Notation for Circuit Diagrams

1. How to identify inter-circuit board connectors
 This indicates the location of the counter inter-circuit board connector. (The alphabet indicates horizontal direction and the number indicates vertical direction.)

2. Connection of connectors.
 (Example) to MASJK-CN304 <Page 32: D-2>
 Page 32 are the page of a circuit diagram.
 D-2 is indicates the location of the counter inter-circuit board connector. (The alphabet indicates horizontal direction and the number indicates vertical direction)

WARNING
 Components having special characteristics are marked with a triangle symbol, and must be replaced with parts having specification equal to those originally installed.
 Note : See parts list for details of circuit board component parts.



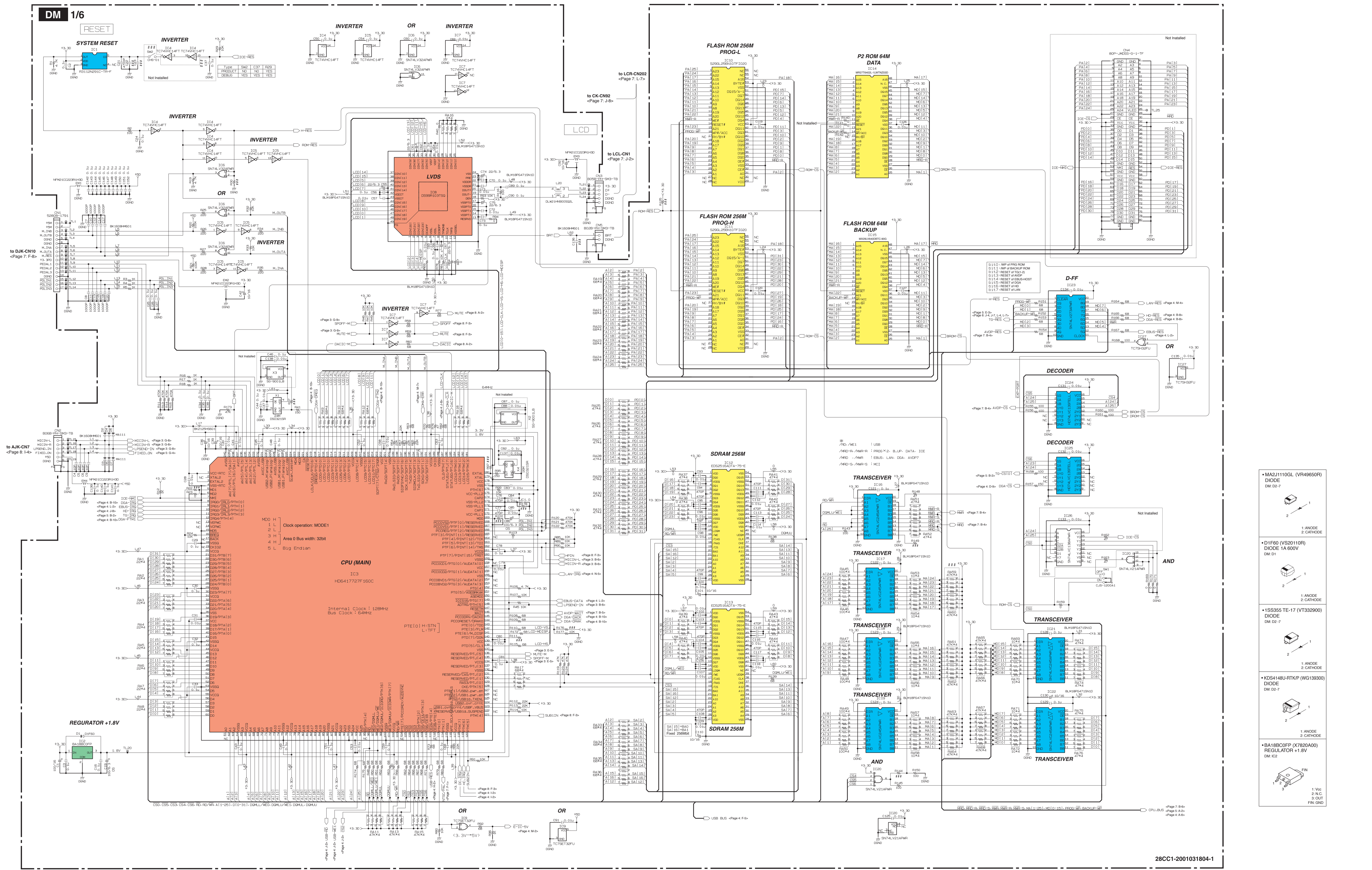
OVERALL ASSEMBLY: 2NC-WN43920-4
 UPPER CASE UNIT: 2NBEX-WN11920-7
 LOWER CASE UNIT: 2NBEX-WN10380-4
 LCD UNIT: 2NBEX-WN13690-3

No.	Unit Name	Location No.	Part No.	Connector Assembly	Destination	Remarks	
①	UPPER CASE UNIT	UC1	(WN54580)	PNLS	PNLS-CN1	10P L=120	
②		UC2	(WQ38330)	VCL	MICVR-CN301	11P L=720	
③		UC3	(WN54570)	PNLR	PNL-CN4	PNR-CN2	13P L=550
④		UC5	WM858800	EBUSP-LF	PNR-CN4	DM-CN205	7P L=450
⑤		UC7	(WM51940)	USB	USB-CN201	DM-CN204	6P L=700
⑥		UC8	VK097400	KRD-KRD	PNC-CN1	EN-CN201	4P L=100
⑦		UC9	WN834100	FFC	PNC-CN2	PNR-CN1	22P L=100
⑧		UC10	(WN74950)	GND1	PNR	USB	LUG/LUG Fixes by a screw
⑨		WHEEL ASSEMBLY	70	(WE84700)	WHEEL	WHEEL ASSEMBLY	PNL-CN6
⑩	LOWER CASE UNIT	LC1	WN754000	HP-LF	HP-CN100	AJK-CN6	6P L=600
⑪		LC2	(WM51340)	ACIN	INLET/POWER SWITCH	SWITCHING POWER SUPPLY-CN1	3P
⑫		LC3	(WN54830)	SW-PNL	SWITCHING POWER SUPPLY-CN5	PNL-CN3	5P/2P L=500
⑬		LC4	(WN75410)	SPR	AJK-CN5	SPOR-CN302	3P L=1500
⑭		LC5	(WM69050)	DM-PWR	SWITCHING POWER SUPPLY-CN2	DM-CN200	7P/6P L=850
⑮		LC6	(WN78550)	AJK-PWR	SWITCHING POWER SUPPLY-CN3	AJK-CN2	3P L=170
⑯		LC7	(WN54840)	SW-CK-HD	SWITCHING POWER SUPPLY-CN6	CK-CN91	2P/6P L=200
⑰		LC8	WP9373400	FFC2	AJK-CN1	DM-CN900	24P L=200

No.	Unit Name	Location No.	Part No.	Connector Assembly	Destination	Remarks	
⑱	LOWER CASE UNIT	LC9	(WM85670)	JKDET-LF	AJK-CN7	DM-CN2	6P
⑲		LC10	(WE84670)	VIDEO	DJK-CN80	DM-CN400	12P L=300
⑳		LC11	WN833700	FFC	DJK-CN10	DM-CN1	17P L=250
㉑		LC12	(WN73550)	USB-PWR	HDSB-CN2	DM-CN201	4P L=210
㉒		LC13	WF76120R	FFC1	HDSB-CN5	DM-CN208	40P L=180 (HDD)
㉓	LC14	(WG26500)	EPPH1	MK61L-CN2	AC LOWER FRAME	3P	
㉔	LC15	(WG26500)	EPPH1	MKH-D-CN5	DM ANGLE	3P	
㉕	LCD UNIT	LD1	WN833900	FFC	LCL-CN5	PNL-CN2	8P L=330
㉖		LD2	WN834000	FFC	LCL-CN4	LCR-CN201	9P L=220
㉗		LD3	WN834200	FFC	LCL-CN2	LCD	32P L=50
㉘		LD4	(WN74960)	GND2	LCD SUPPORT STAY	PANEL STAY	Flat type lug / L type lug
㉙		LD9	(WN54850)	CK-LC-DM	LCR-CN202	CK-CN92	4P/5P L=1000
㉚	LD10	WM519500	LVDS	LCL-CN1	DM-CN3	4P/2P L=750	
㉛	AJK CIRCUIT BOARD	W1	(WE84550)	SPL	AJK-W1	SPOL-CN303	2P L=250
㉜		W3	(WN89510)	GND3	AJK-W3	AC UPPER FRAME	PIN/LUG L=130
㉝	HDSB CIRCUIT BOARD	W1	(WP24390)	GND4	HDSB-W1	DM ANGLE	PIN/LUG L=90
㉞		W2	(WP24390)	GND4	HDSB-W2	DM ANGLE	PIN/LUG L=90

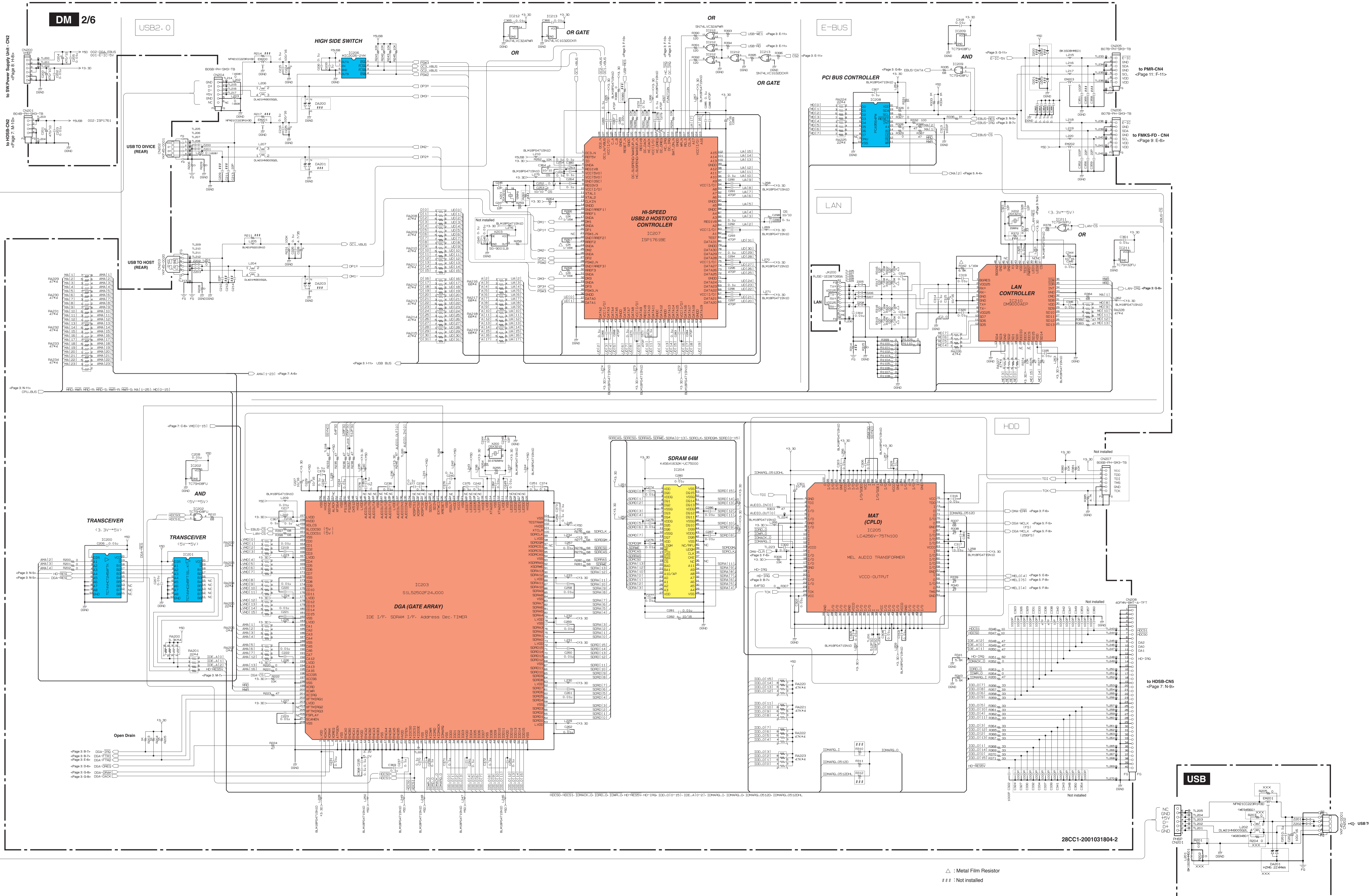
■ : DATA LINE FILTER
 ○ : CORD BINDER

The parts that correspond to the number with () are not prepared as service parts.



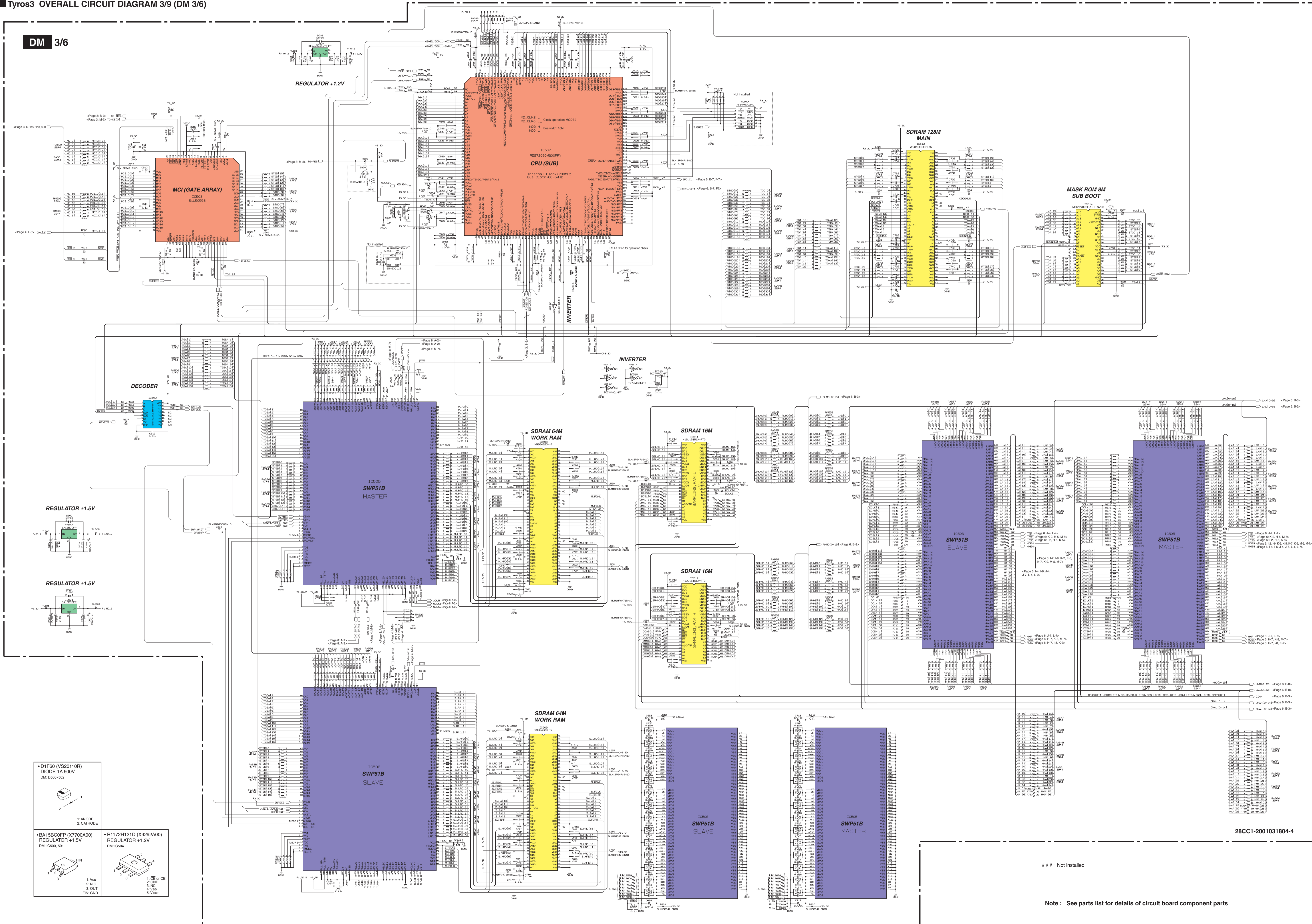
- MA21110GL (VR49650R) DIODE DM 02-7
- D1F80 (VS20110R) DIODE 1A 600V DM 01-1
- 1SS355 TE-17 (VT332900) DIODE DM 02-7
- KDS4148U-RTK/P (WG139300) DIODE DM 02-7
- BA180C0P (X782A00) REGULATOR +1.8V DM IC2

: Not installed
 Note : See parts list for details of circuit board component parts



Note: See parts list for details of circuit board component parts

DM 3/6



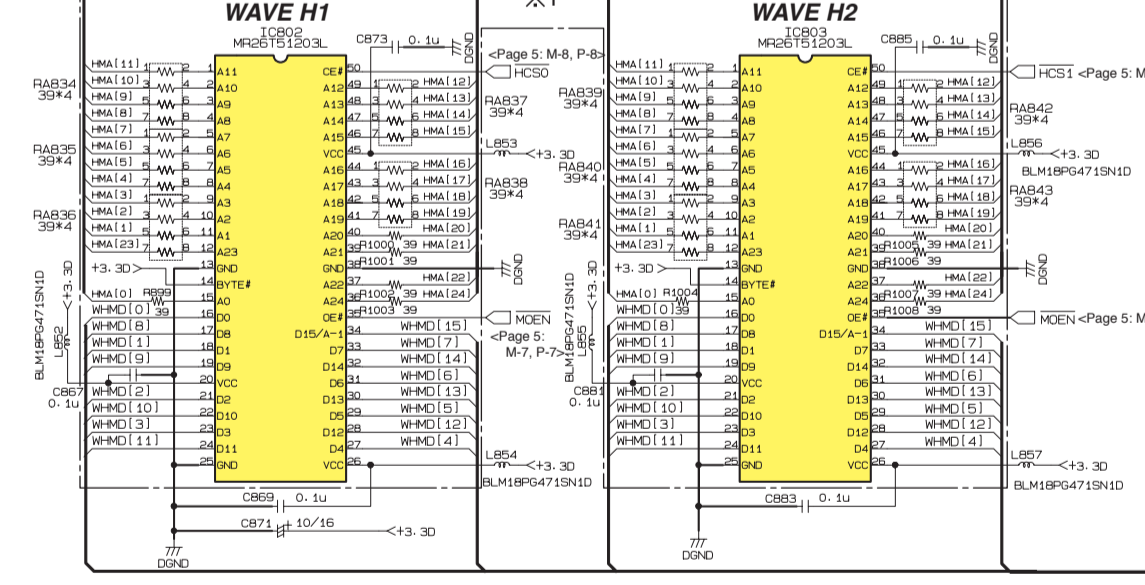
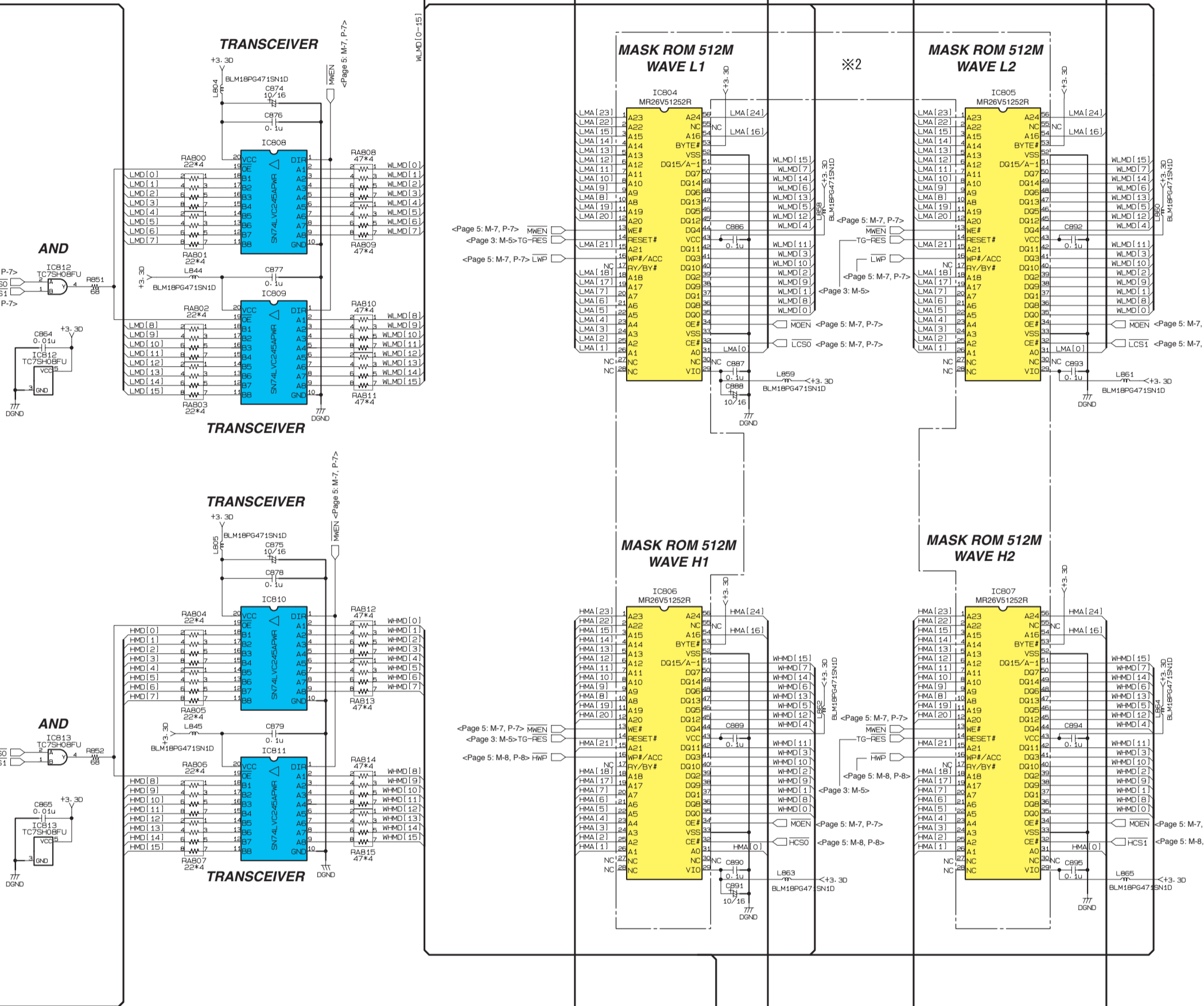
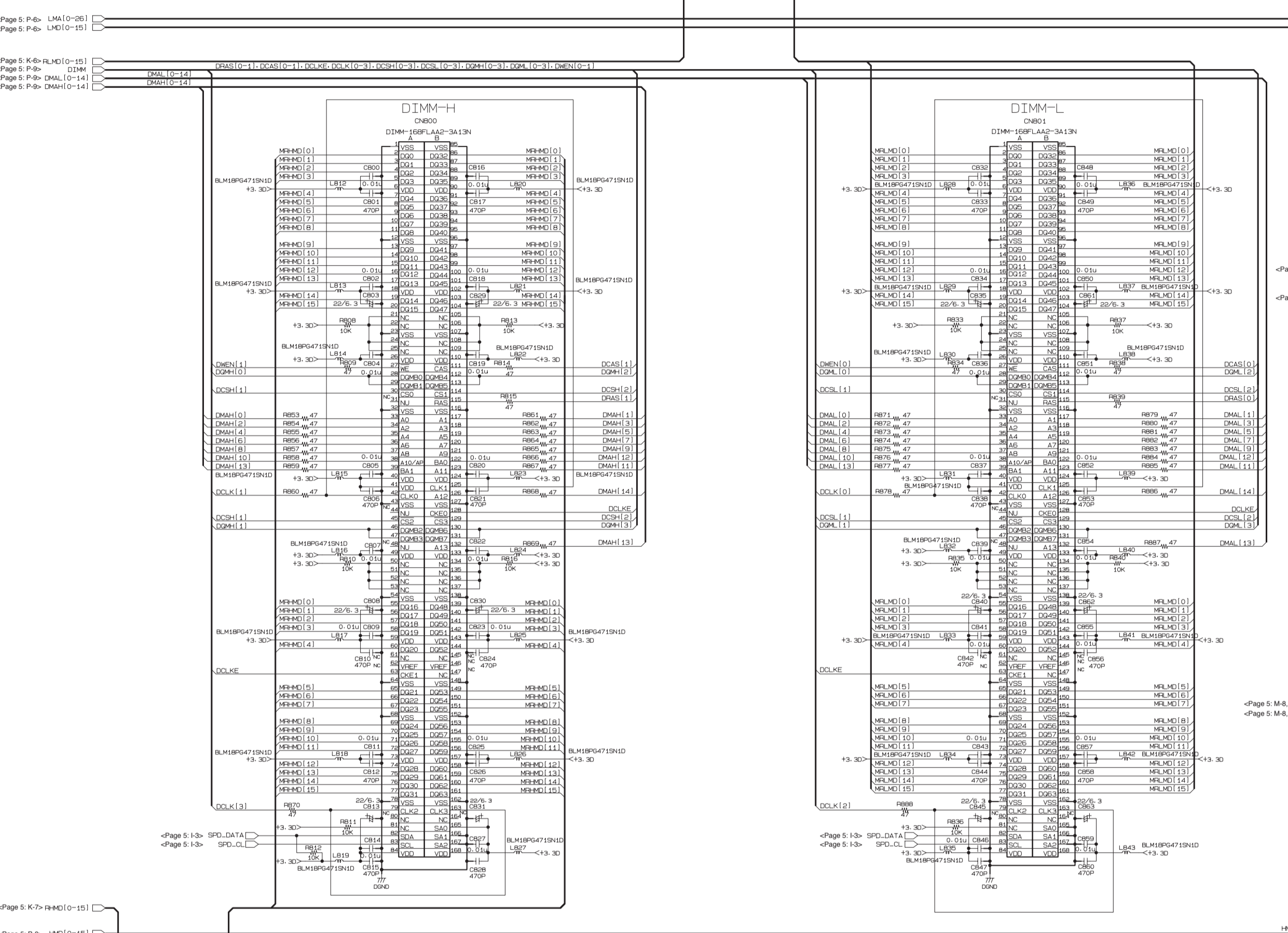
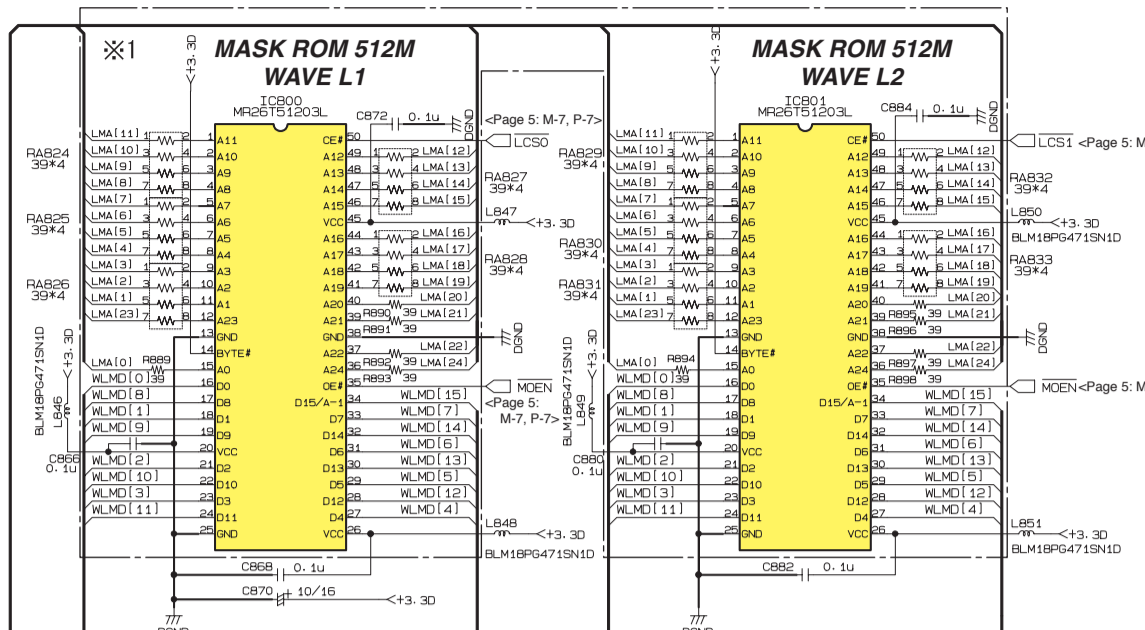
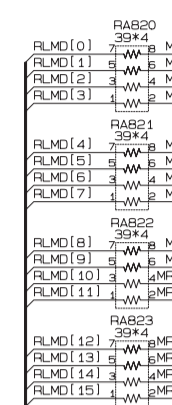
- D1F60 (VS20110R)
DIODE 1A 600V
DM 5500-502
- BA15BC0FP (X7700A00)
REGULATOR +1.5V
DM IC500-501
- R1172H121D (X9282A00)
REGULATOR +1.2V
DM IC504

28CC1-2001031804-4

: Not installed

Note : See parts list for details of circuit board component parts

DM 4/6

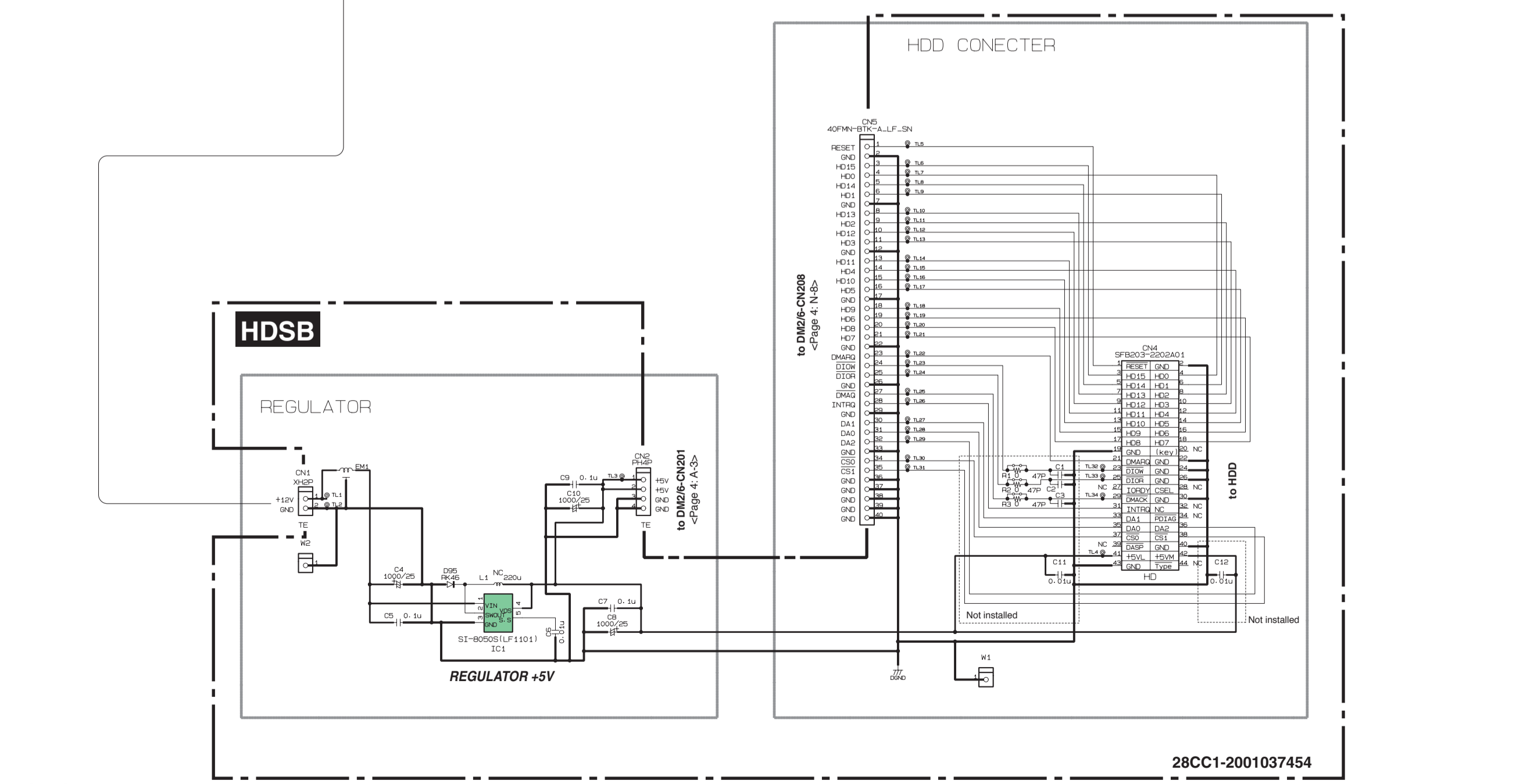
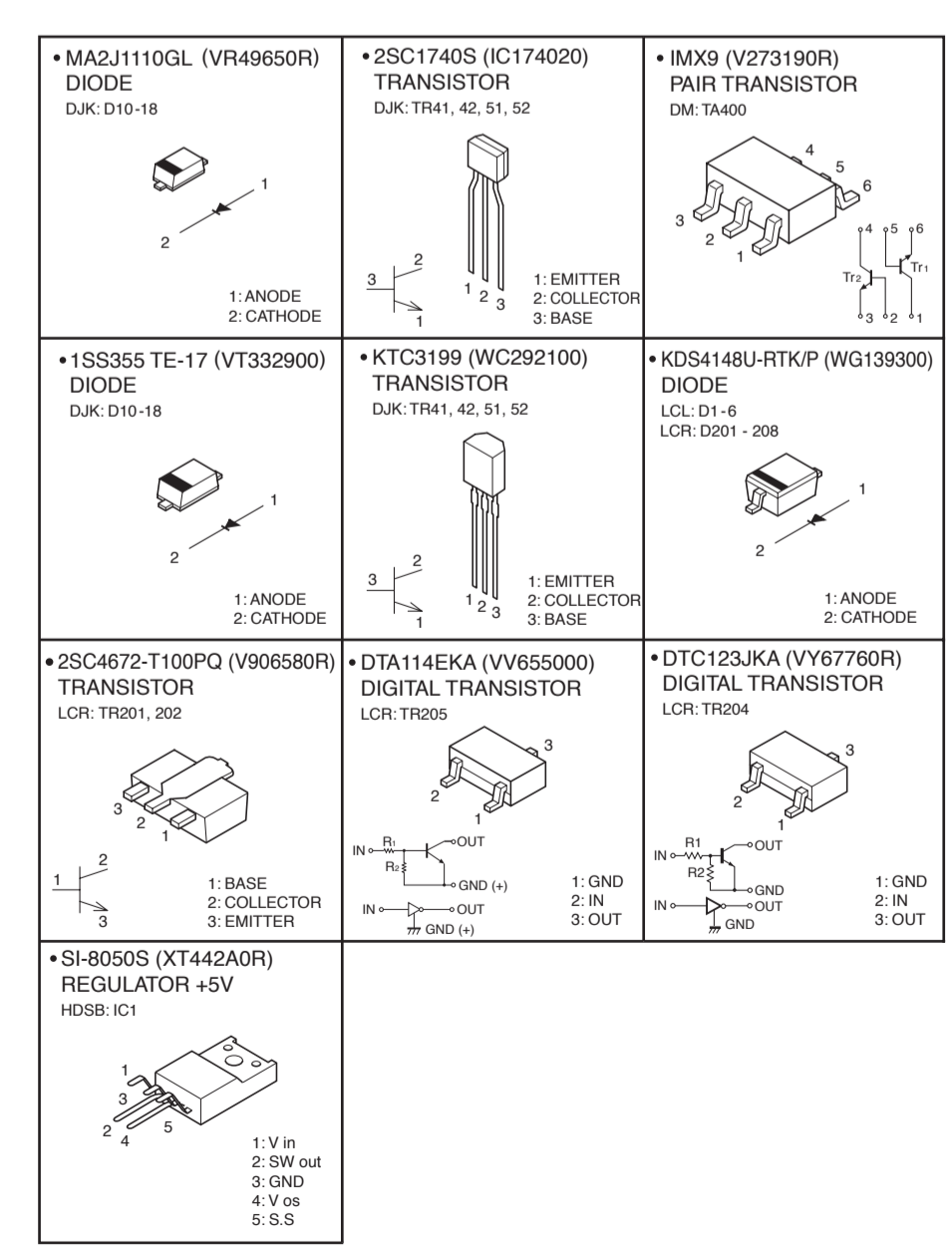
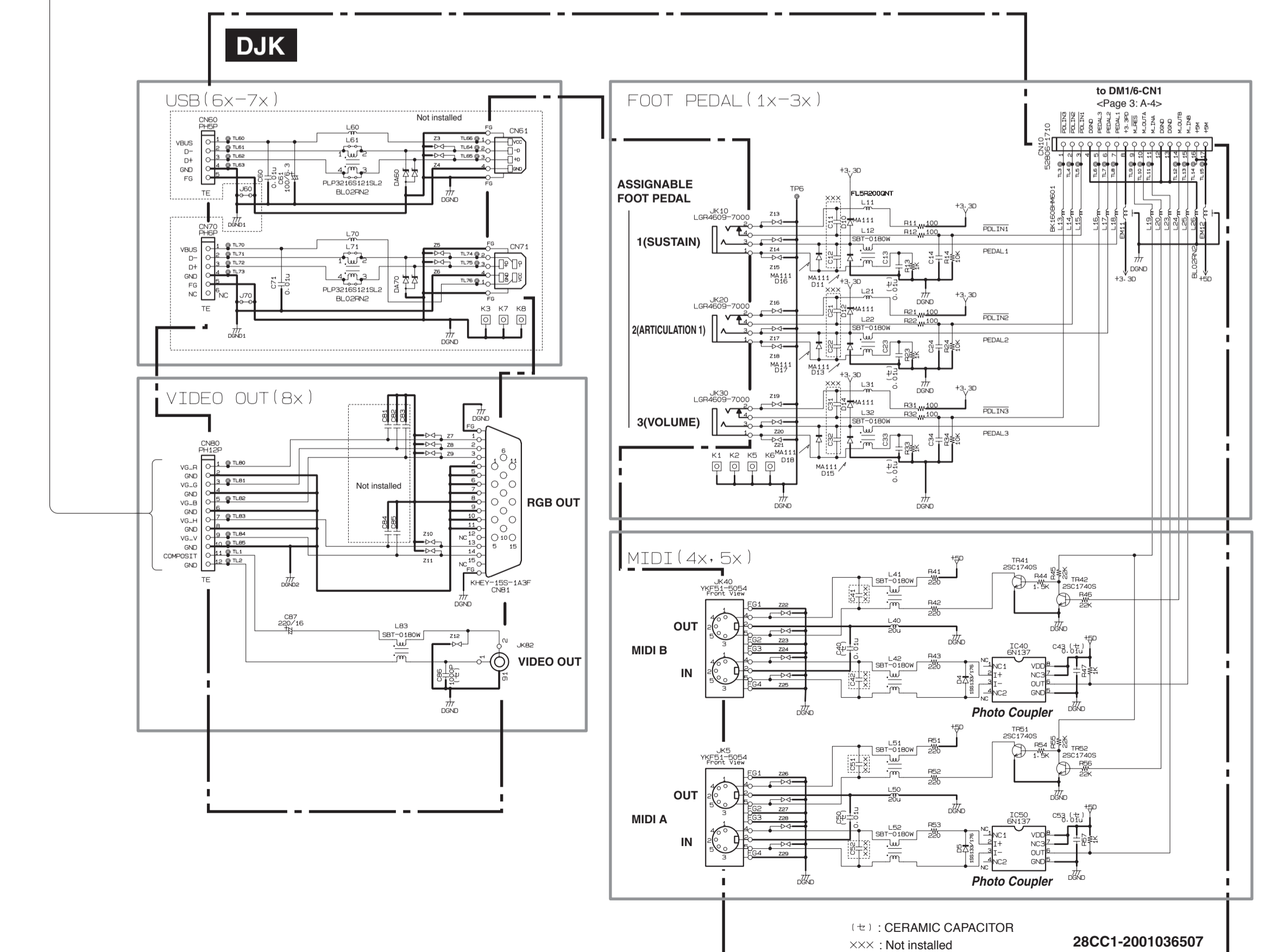
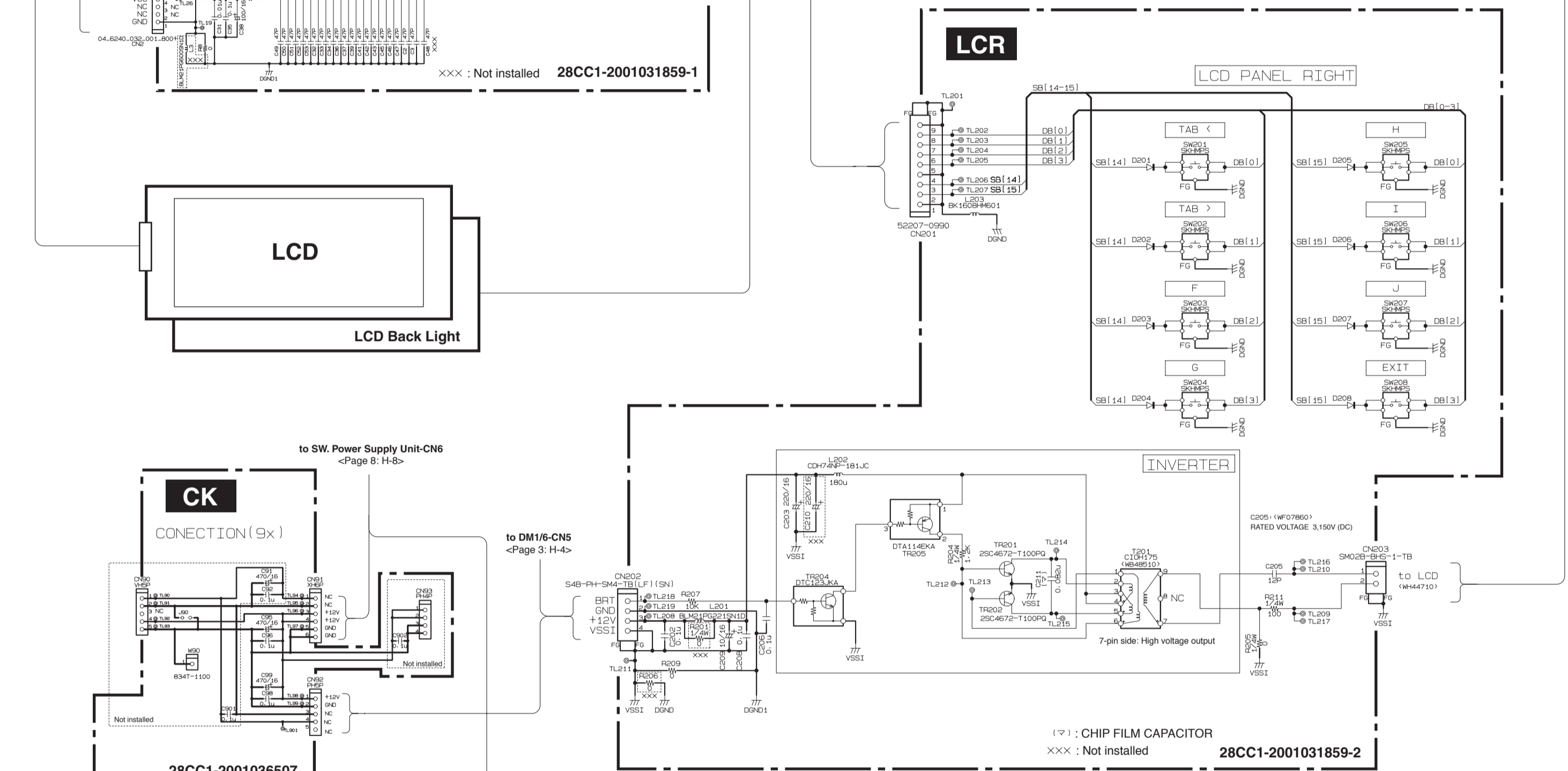
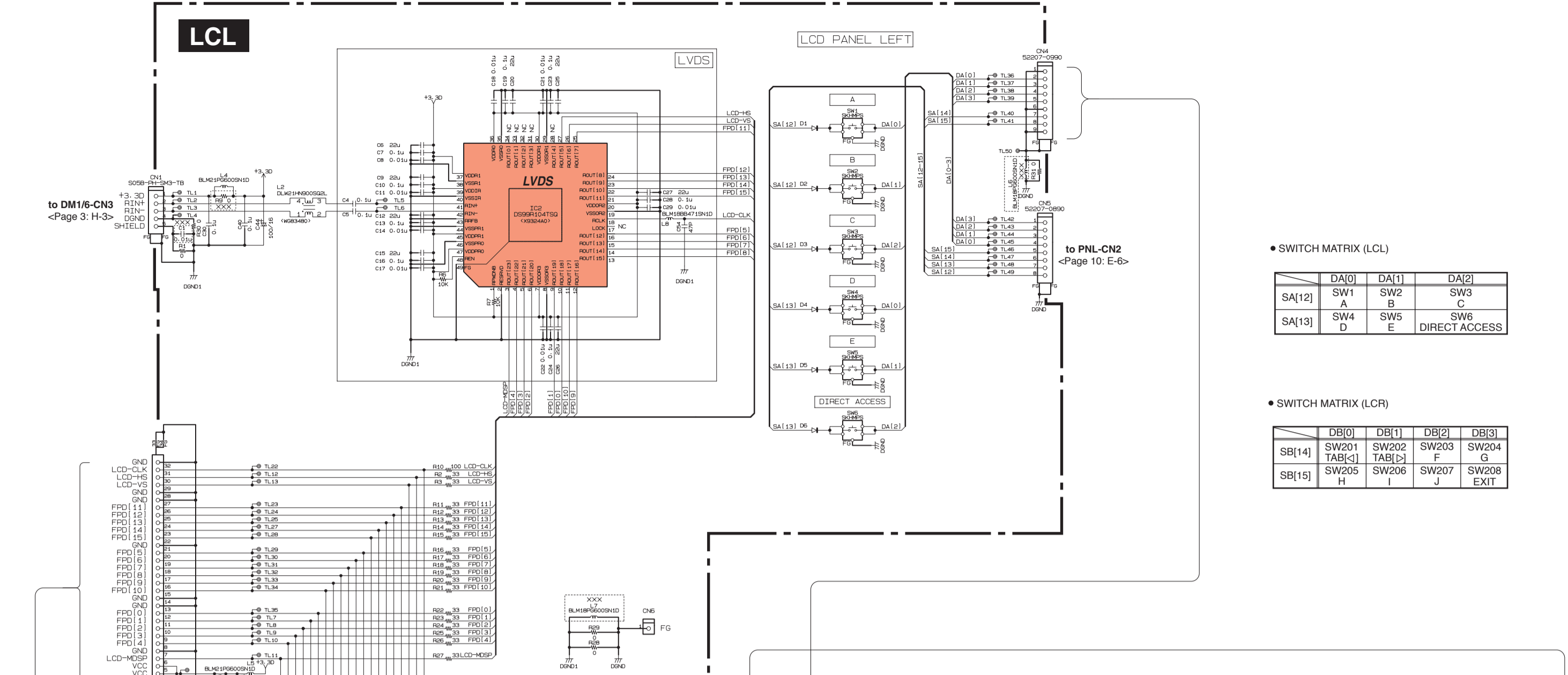
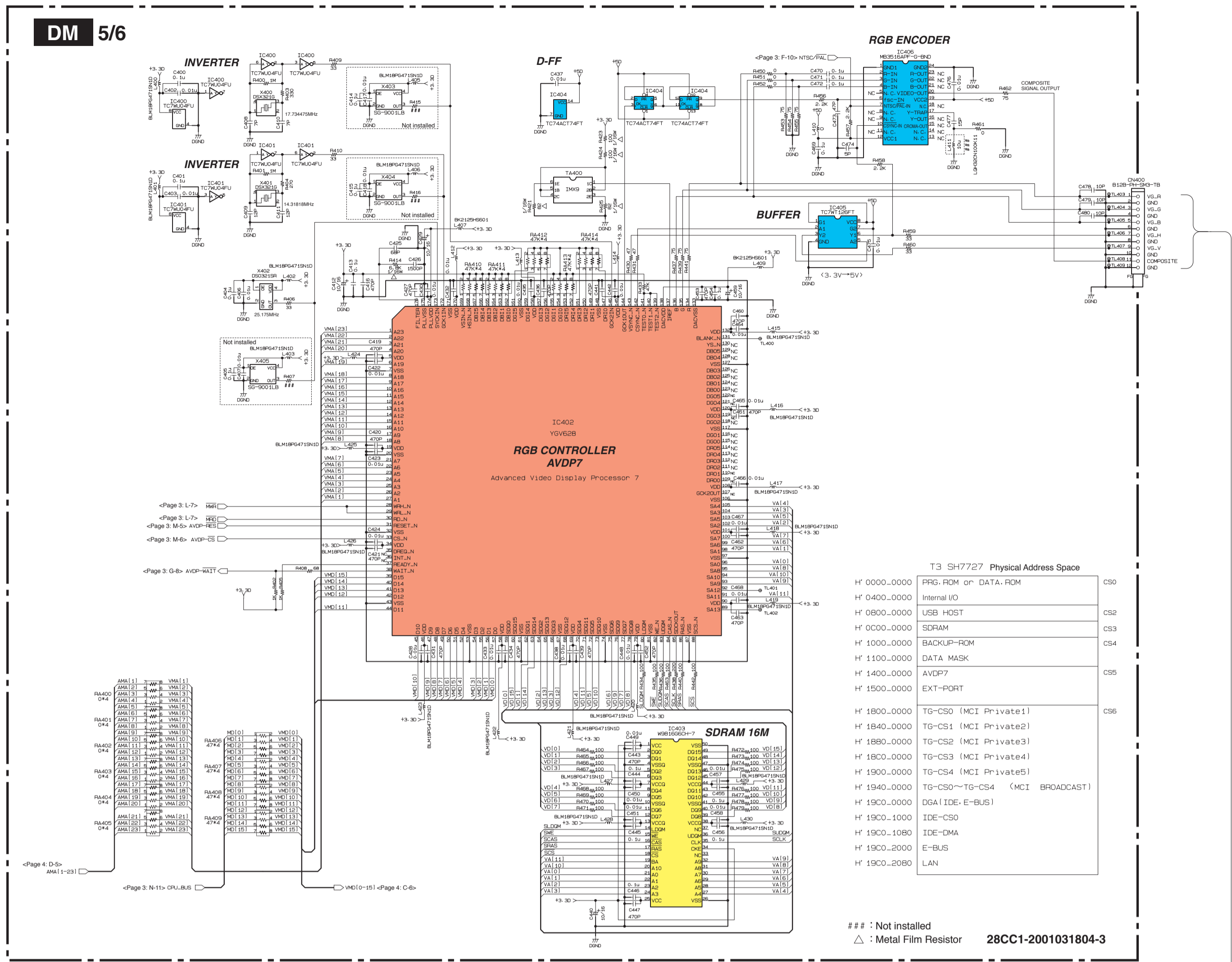


28CC1-2001031804-5

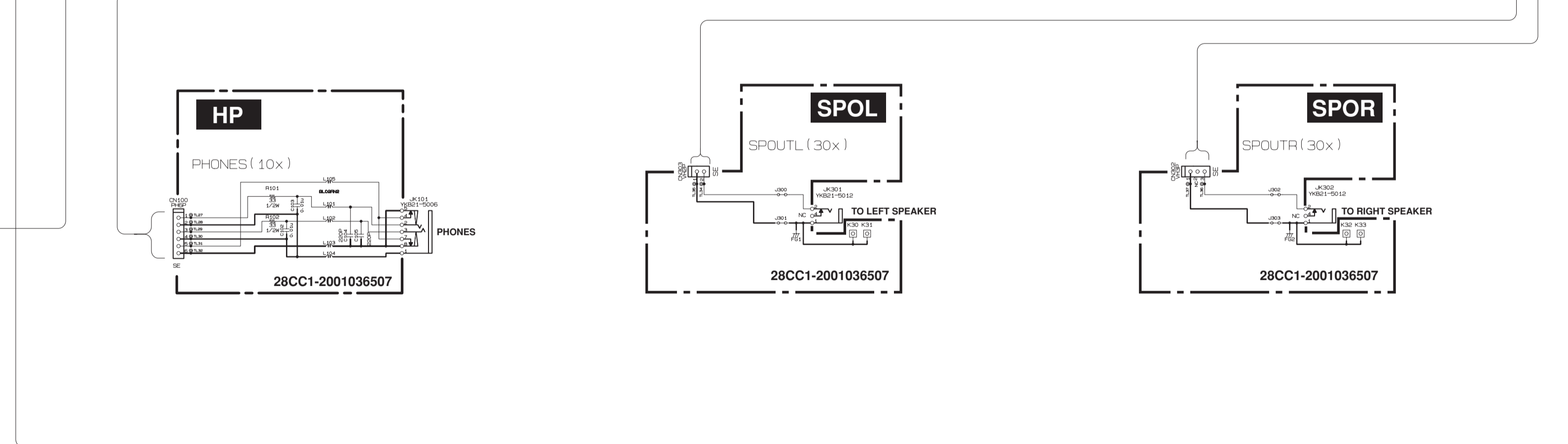
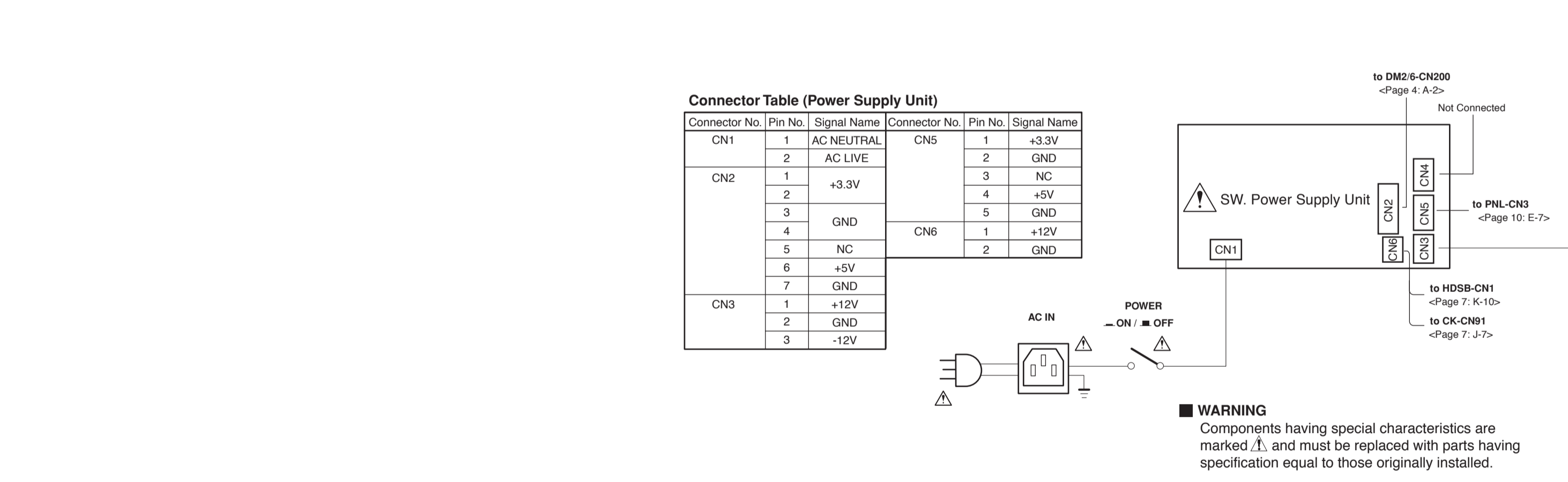
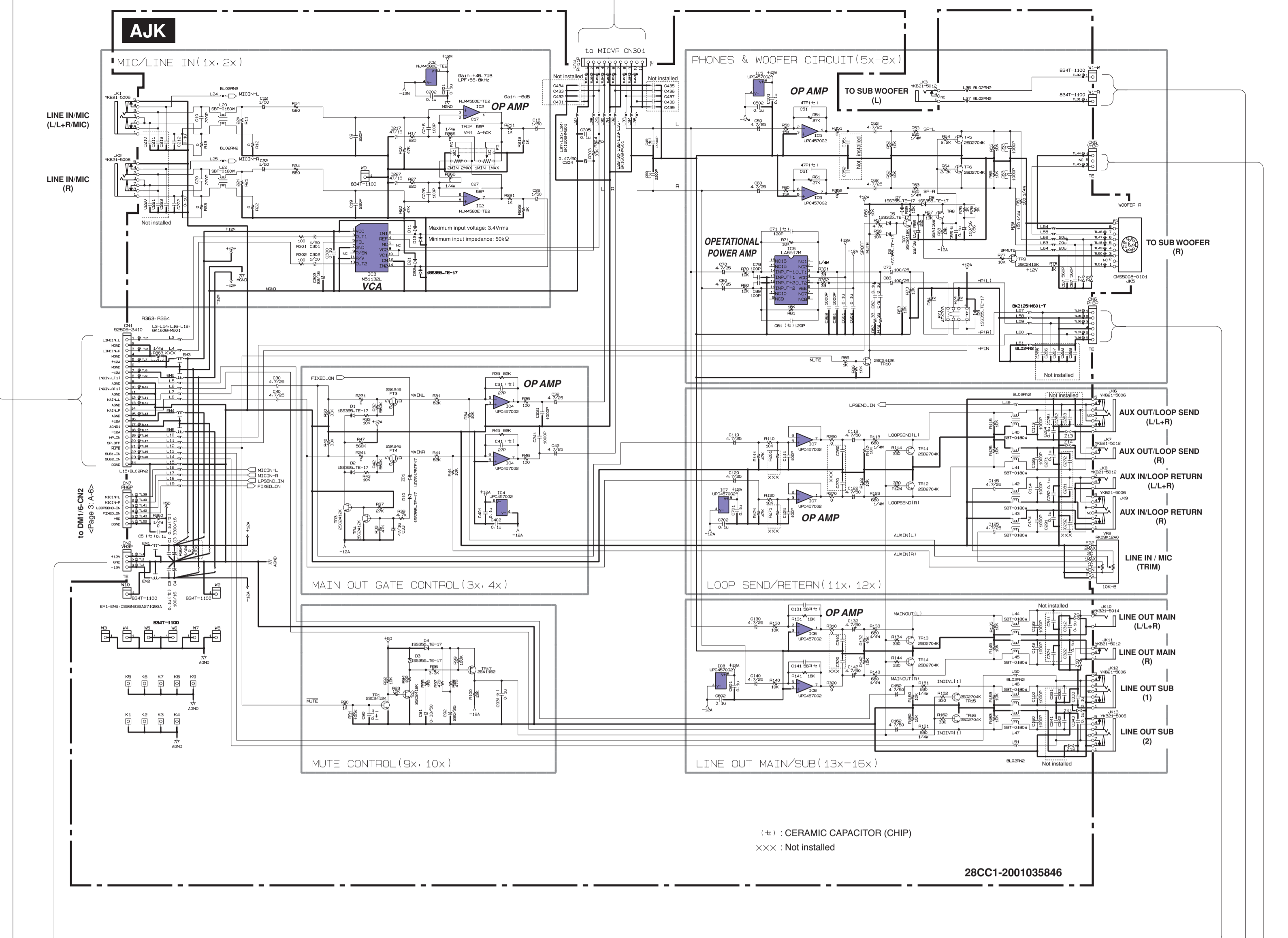
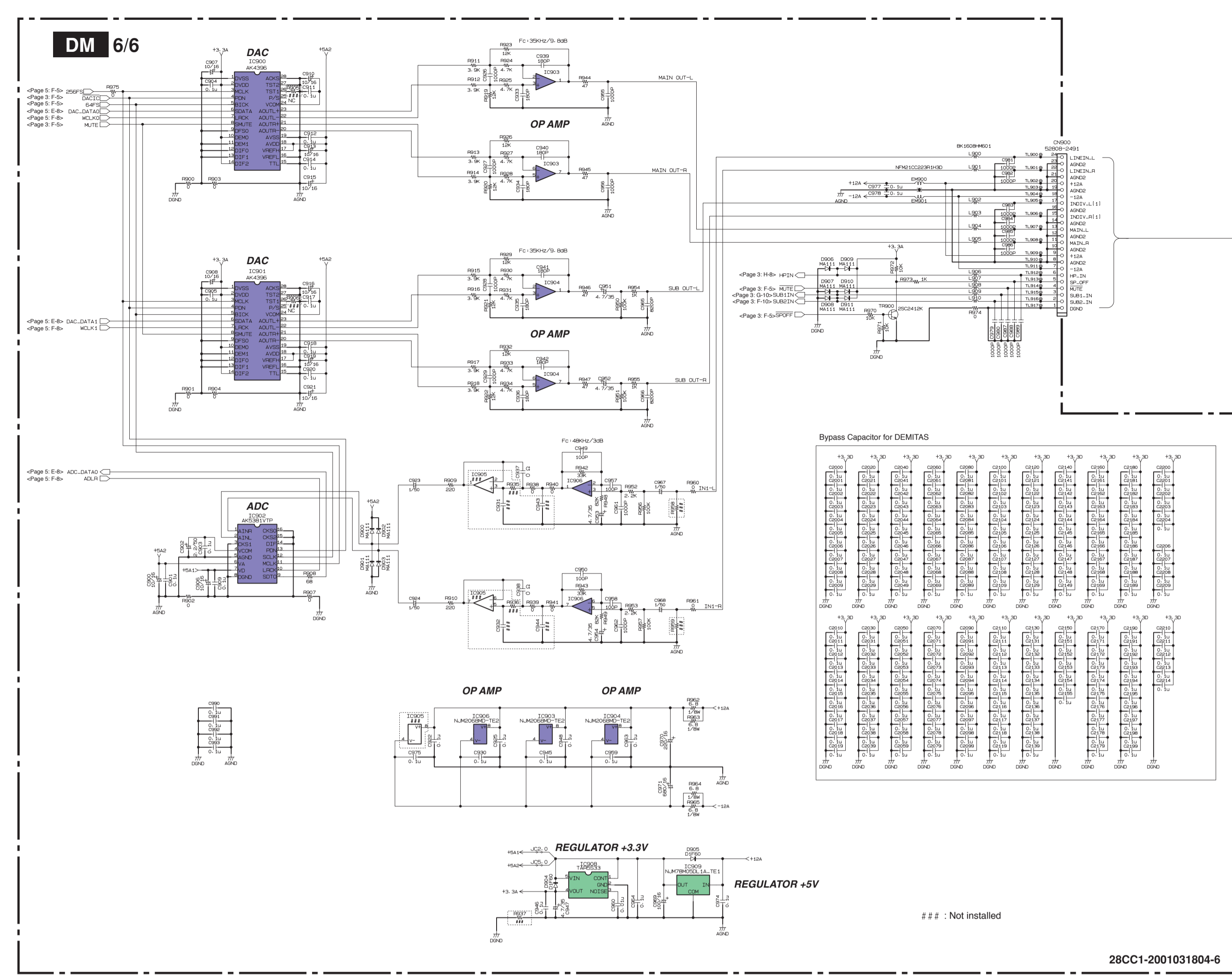
: Not installed Note : See parts list for details of circuit board component parts

Parts marked with "※1" are applicable to products with serial numbers up to B00 01470, E00 02830, U00 01285 and ET00 01125.

Parts marked with "※2" are applicable to products with serial numbers from B00 01471, E00 02831, U00 01286 and ET00 01126 and up.

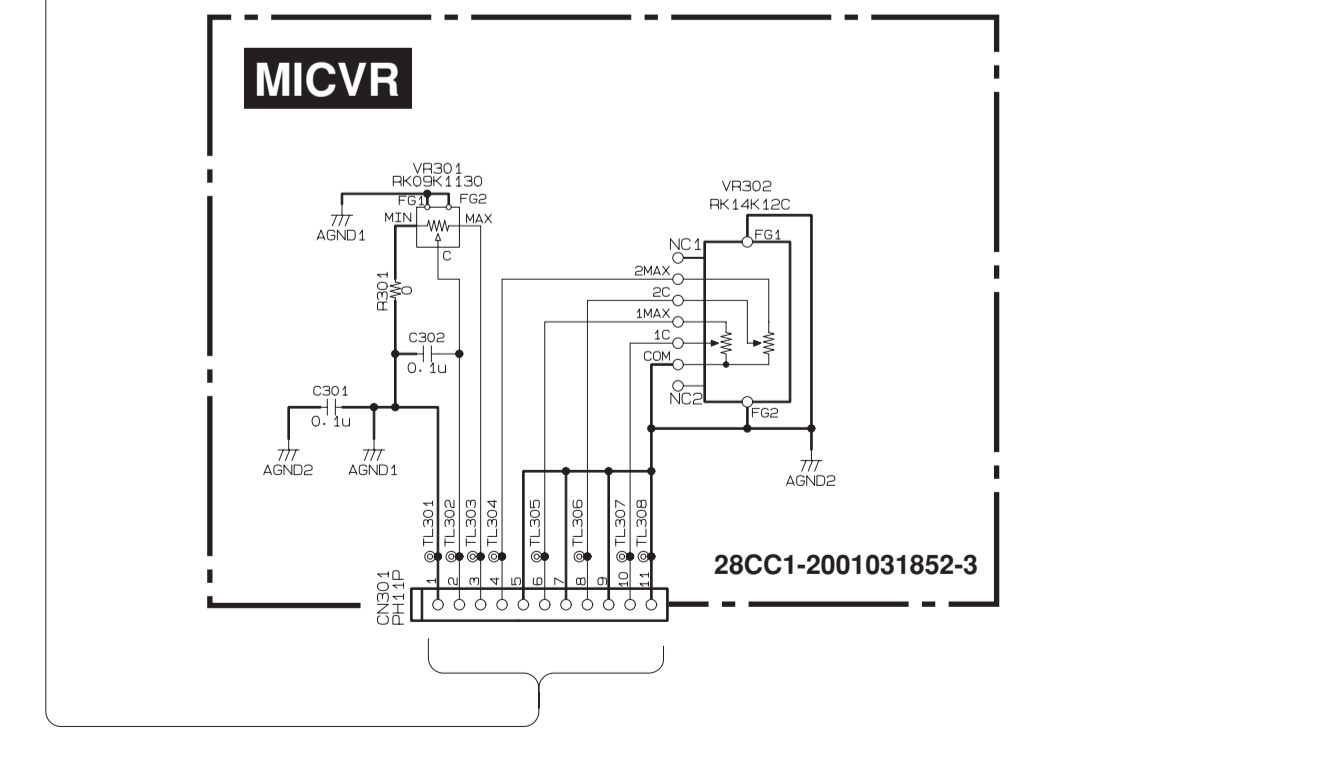


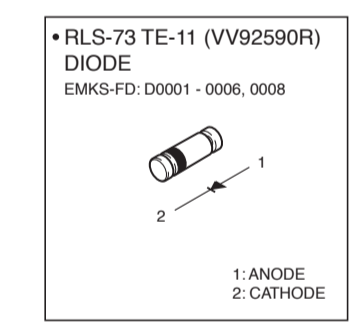
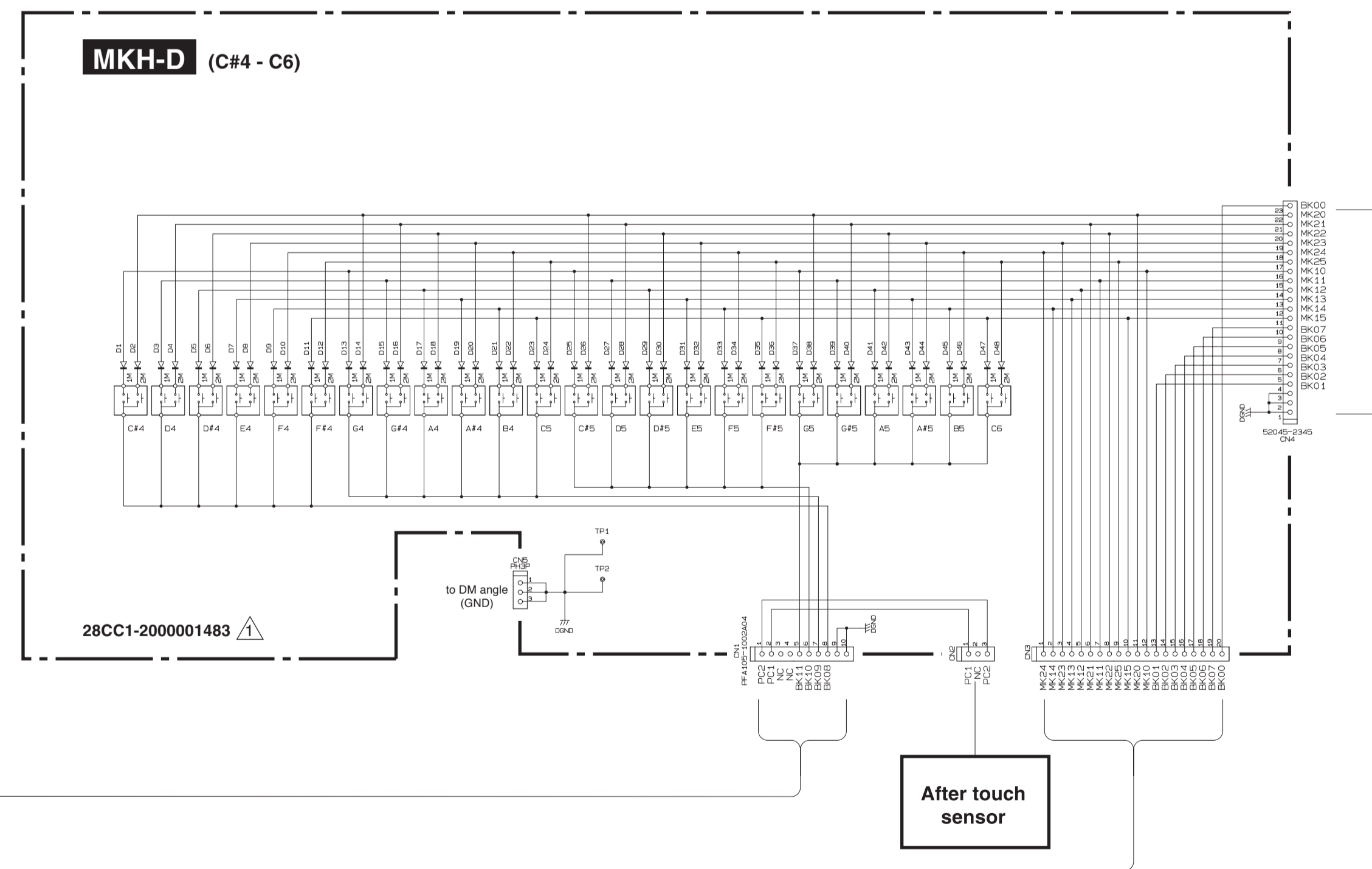
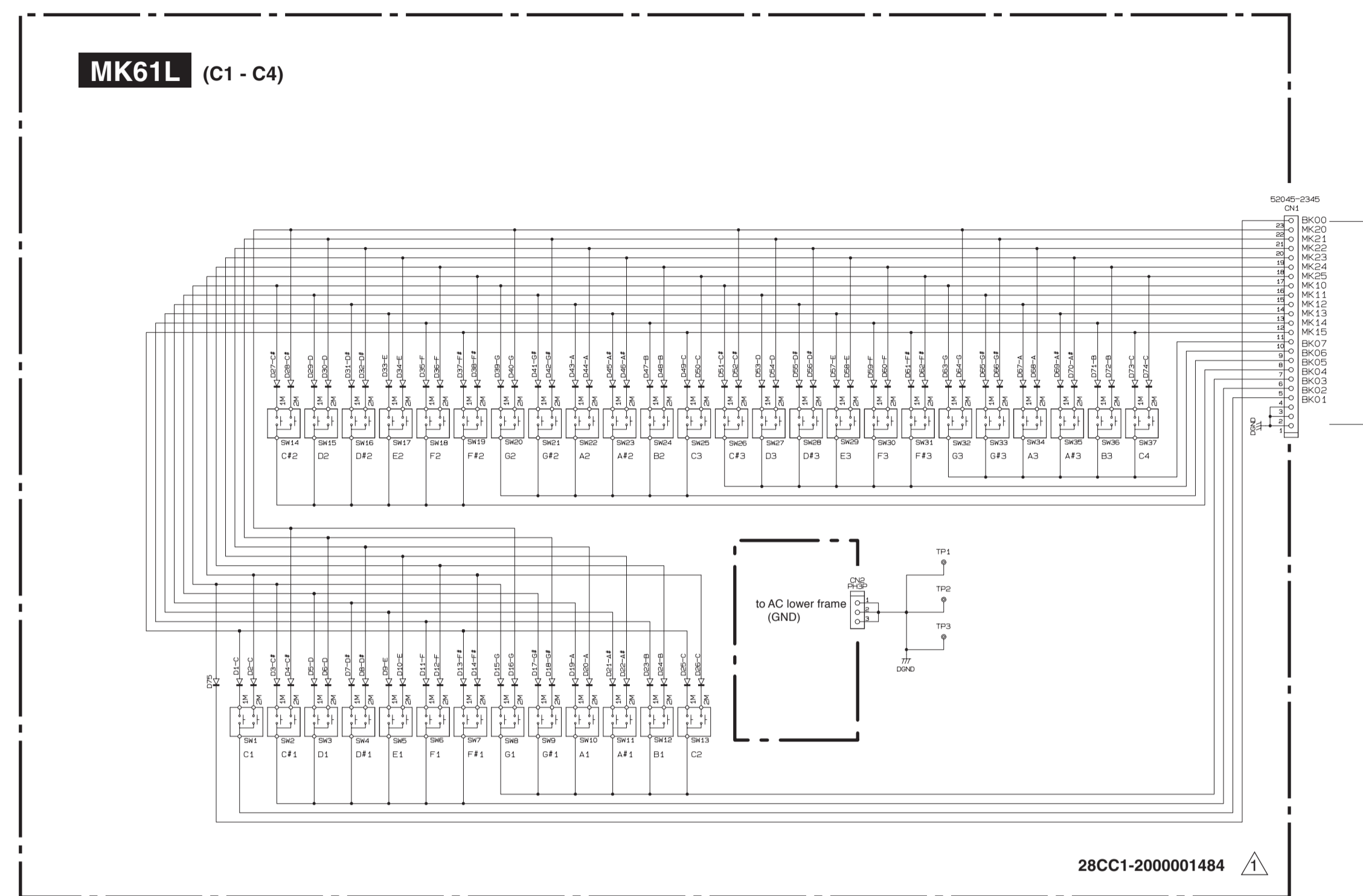
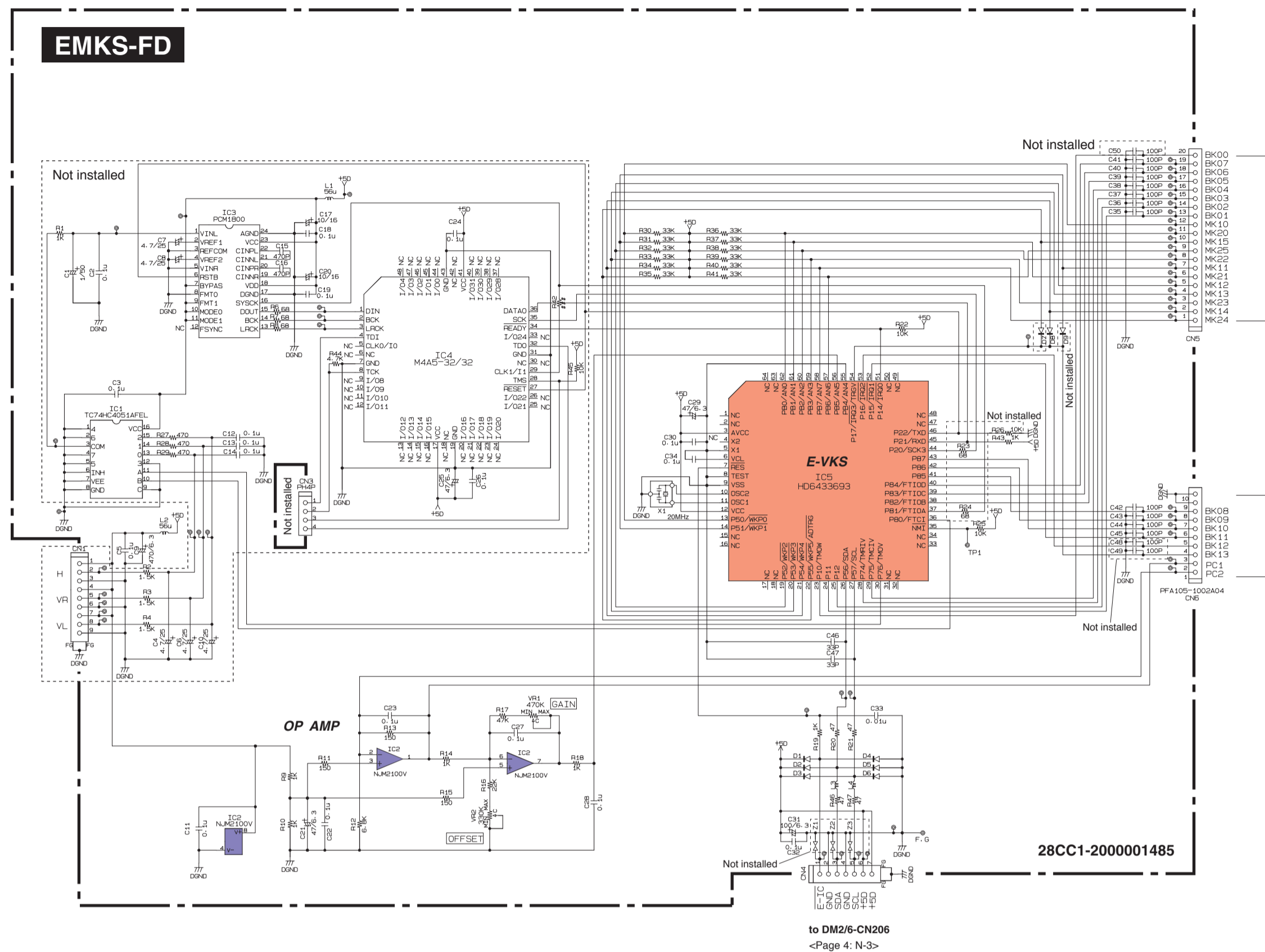
Note : See parts list for details of circuit board component parts



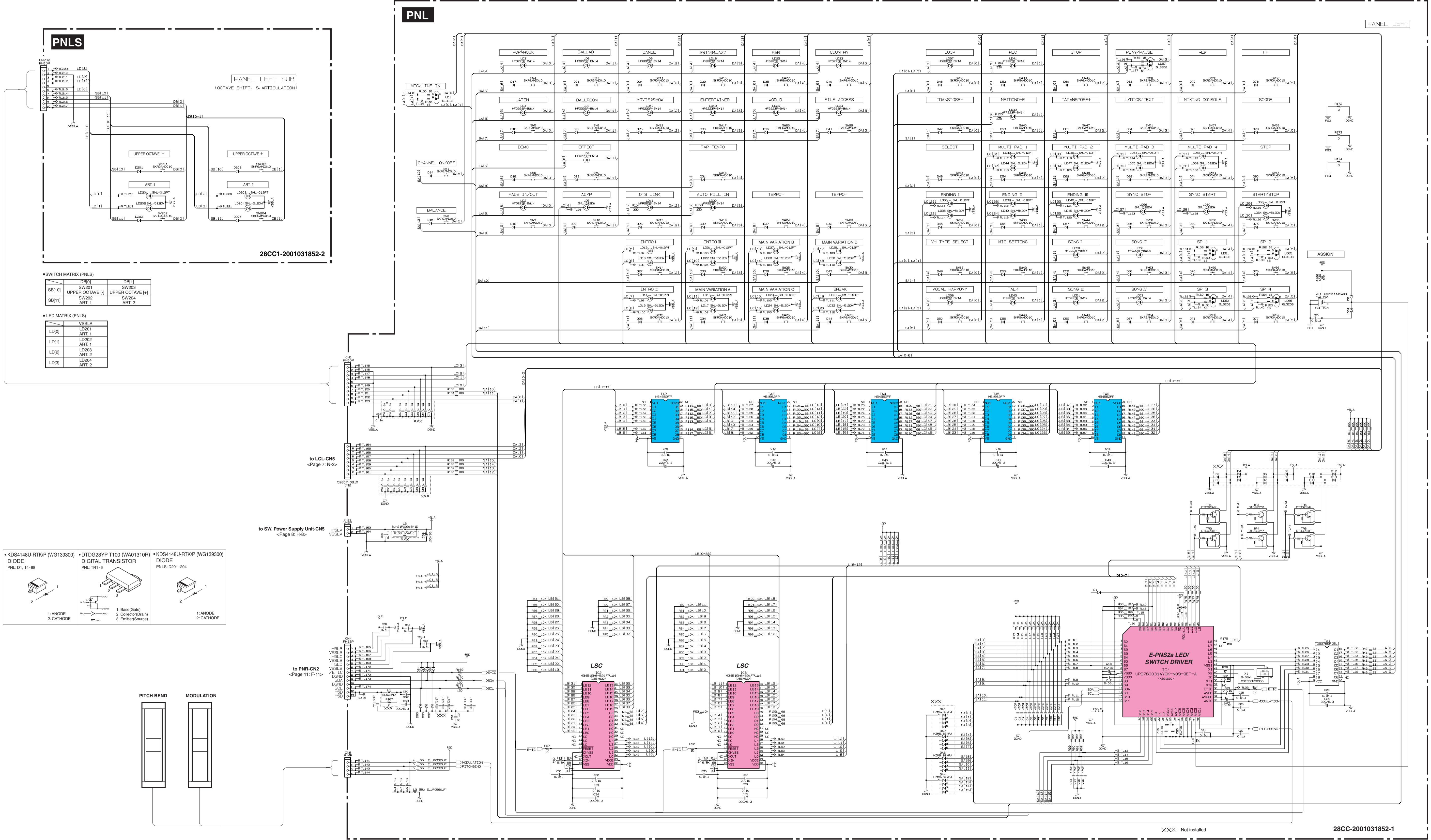
<p>• MA2J110GL (VR49650R)</p> <p>DIODE</p> <p>DM: D900-903, 906-911</p> <p>1: ANODE 2: CATHODE</p>	<p>• D1F60 (VS20110R)</p> <p>DIODE 1A 600V</p> <p>DM: DM04, 905</p> <p>1: ANODE 2: CATHODE</p>	<p>• NJM78M05DL1A (X5S34A00)</p> <p>REGULATOR +5V</p> <p>DM: IC309</p> <p>1: INPUT 2: GND 3: OUTPUT</p>	<p>• TAR5S33 (XZ642A00)</p> <p>REGULATOR +3.3V</p> <p>DM: IC308</p> <p>1: VIN 2: GND 3: VOUT</p>	<p>• 2SC2412K (VV556400)</p> <p>TRANSISTOR</p> <p>DM: TR90</p> <p>1: EMITTER 2: BASE 3: COLLECTOR</p>	<p>• KTC3875S (WC52940R)</p> <p>TRANSISTOR</p> <p>DM: TR90</p> <p>1: EMITTER 2: BASE 3: COLLECTOR</p>	<p>• MA2J110GL (VR49650R)</p> <p>DIODE</p> <p>AJK: D1-12, 21, 22</p> <p>1: ANODE 2: CATHODE</p>	<p>• 1SS355 TE-17 (VT332900)</p> <p>DIODE</p> <p>AJK: D1-12, 21, 22</p> <p>1: ANODE 2: CATHODE</p>	<p>• KDS4148U-RTK1P (WG139300)</p> <p>DIODE</p> <p>AJK: TR5, 6, 11-16</p> <p>1: ANODE 2: CATHODE</p>	<p>• UDZS12B TE-17 (VU172800)</p> <p>ZENER DIODE 12V</p> <p>AJK: ZD1</p> <p>1: ANODE 2: CATHODE</p>
<p>• 1SS355 TE-17 (VT332900)</p> <p>DIODE</p> <p>DM: D900-903, 906-911</p> <p>1: ANODE 2: CATHODE</p>	<p>• KDS4148U-RTK1P (WG139300)</p> <p>DIODE</p> <p>DM: D900-903, 906-911</p> <p>1: ANODE 2: CATHODE</p>	<p>• 2SK246-Y (IE10262R)</p> <p>FET</p> <p>AJK: FT3, 4</p> <p>1: SOURCE 2: GATE 3: DRAIN</p>	<p>• 2SA1162-Y (VJ92720R)</p> <p>TRANSISTOR</p> <p>AJK: TR8, 17</p> <p>1: BASE 2: EMITTER 3: COLLECTOR</p>	<p>• KTA1504S-Y (WC52950R)</p> <p>TRANSISTOR</p> <p>AJK: TR8, 17</p> <p>1: EMITTER 2: BASE 3: COLLECTOR</p>	<p>• 2SA1037AK (VV556500)</p> <p>TRANSISTOR</p> <p>AJK: TR8, 17</p> <p>1: BASE 2: EMITTER 3: COLLECTOR</p>	<p>• KTC3875S (WC52940R)</p> <p>TRANSISTOR</p> <p>AJK: TR3-4, 7, 9, 10</p> <p>1: EMITTER 2: BASE 3: COLLECTOR</p>	<p>• 2SC2412K (VV556400)</p> <p>TRANSISTOR</p> <p>AJK: TR1-4, 7, 9, 10</p> <p>1: EMITTER 2: BASE 3: COLLECTOR</p>	<p>• 2SD2704K (WC883400)</p> <p>FET</p> <p>AJK: TR5, 6, 11-16</p> <p>1: EMITTER 2: BASE 3: COLLECTOR</p>	

Note : See parts list for details of circuit board component parts





Note : See parts list for details of circuit board component parts

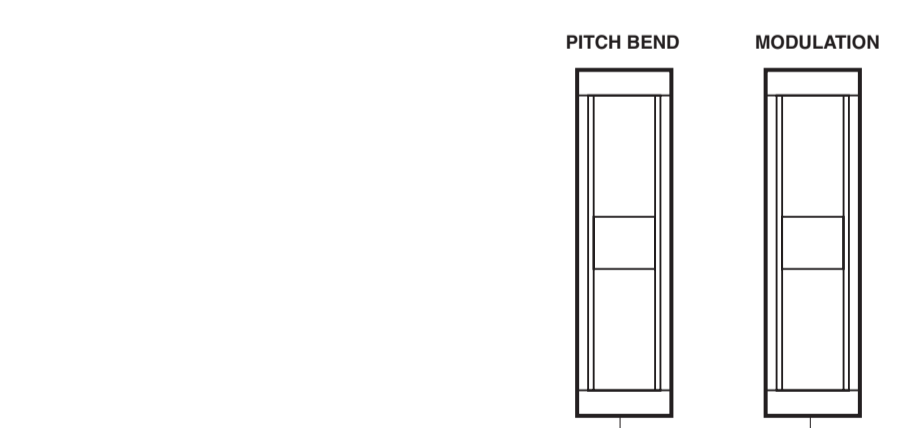
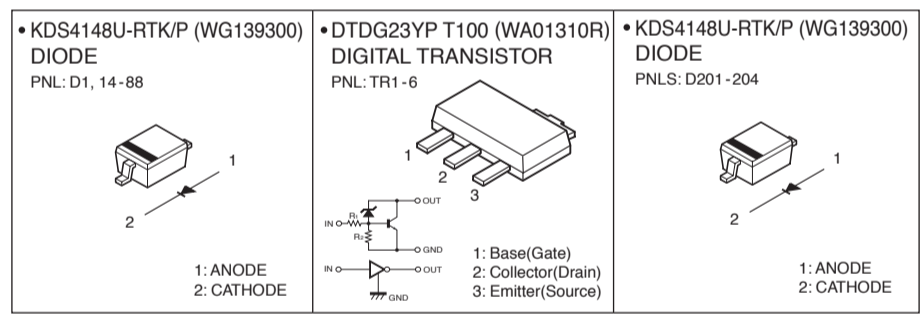


SWITCH MATRIX (PNLS)

SR10	DSB1	DSB1
SR11	SW201	SW203
	UPPER OCTAVE [-]	UPPER OCTAVE [+]
	SW202	SW204
	ART 1	ART 2

LED MATRIX (PNLS)

LD0	LD01
LD1	ART 1
LD2	ART 2
LD3	LD04



SWITCH MATRIX (PNL)

SA0	SW3	SW39	SW46	SW50	SW56	SW6
SA1	SONG [LOOP]	SONG [REC]	SONG [STOP]	SONG [PLAY/PAUSE]	SONG [REW]	SONG [FF]
SA2	TRANSPOSE [-]	SONG [METRONOME]	TRANSPOSE [+]	SONG [LYRICS/TEXT]	MIXING CONSOLE	SONG [SCORE]
SA3	MULTI PAD CONTROL [SELECT]	MULTI PAD CONTROL [1]	MULTI PAD CONTROL [2]	MULTI PAD CONTROL [3]	MULTI PAD CONTROL [4]	MULTI PAD CONTROL [STOP]
SA4	ENDING I [I]	ENDING II [II]	ENDING III [III]	STYLE CONTROL [SYNC STOP]	STYLE CONTROL [SYNC START]	STYLE CONTROL [START/STOP]
SA5	MIC [V.H TYPE SELECT]	MIC [MIC SETTING]	SONG [I]	SONG [II]	SONG [SP 1]	SONG [SP 2]
SA6	MIC [VOCAL HARMONY]	MIC [TALK]	SONG [III]	SONG [IV]	SONG [SP 3]	SONG [SP 4]
SA7	STYLE [POP & ROCK]	STYLE [BALLAD]	STYLE [DANCE]	STYLE [MOVIE & JAZZ]	STYLE [R & B]	STYLE [COUNTRY]
SA8	STYLE [IN]	STYLE [BALLROOM]	STYLE [MOVIE & SHOW]	STYLE [ENTERTAINER]	STYLE [WORLD]	STYLE [FILE ACCESS]
SA9	DEMO	MIC [EFFECT]	TAP TEMPO	SW19	SW29	
SA10	FADE IN/OUT	STYLE CONTROL [ACMP]	STYLE CONTROL [OTS LINK]	STYLE CONTROL [AUTO FILL IN]	TEMPO [-]	TEMPO [+]
SA11		SW14	SW14	SW20	SW29	SW30
SA12		SW15	SW15	MAIN VARIATION [B]	MAIN VARIATION [C]	MAIN VARIATION [D]
SA13		SW1	SW1	MAIN VARIATION [A]	MAIN VARIATION [C]	STYLE CONTROL [BREAK]
						CHANNEL ON/OFF
						BALANCE

LED MATRIX (PNL)

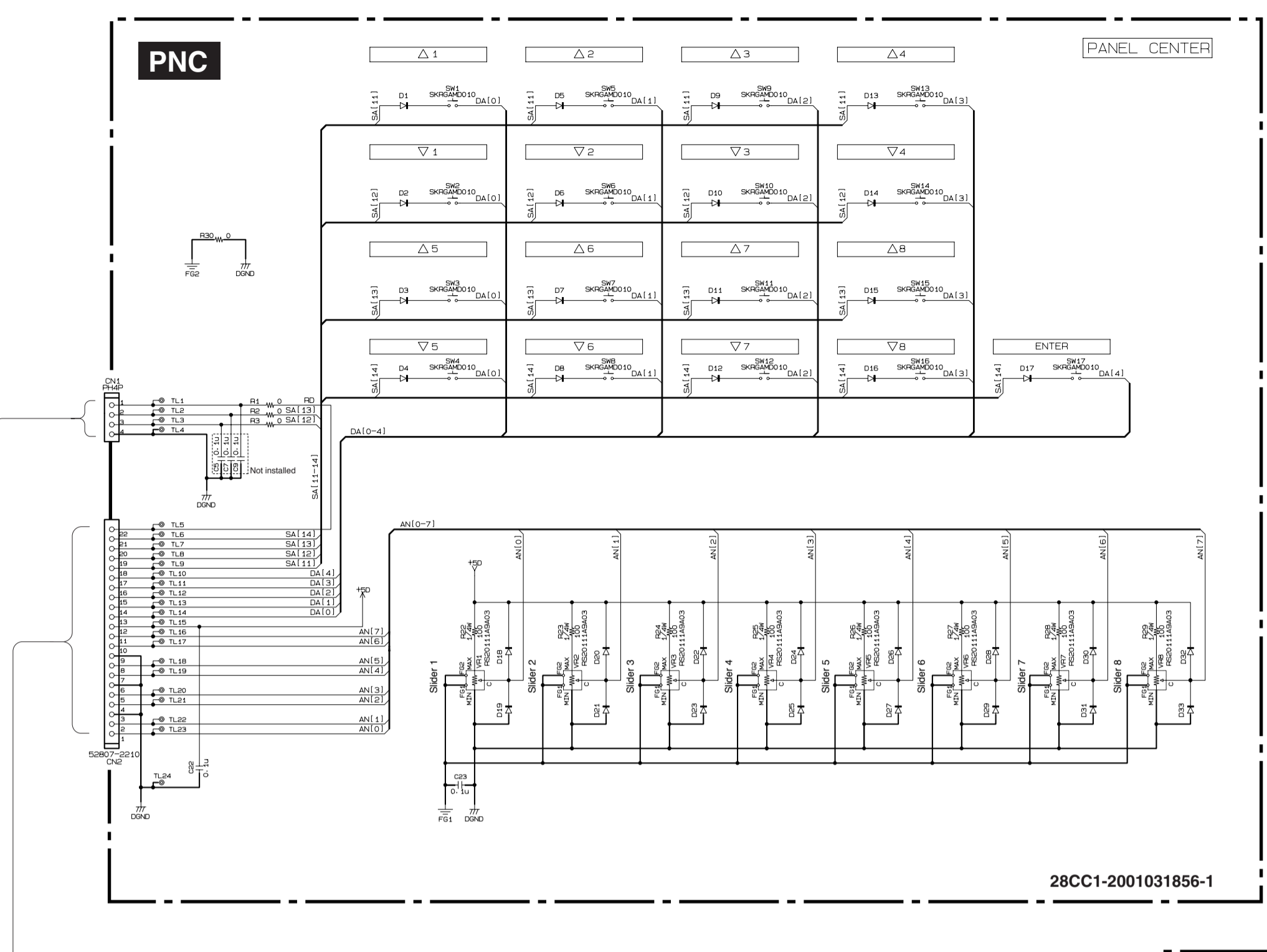
LA0	LD1 <GREEN> SIGNAL	LD41	SONG [REC]	LD50	SONG [I]	LD55	SONG [II]	LD60	SONG [III]	LD65	SONG [IV]	LD70	SONG [SP 1]	LD75	SONG [SP 2]	LD80	SONG [SP 3]	LD85	SONG [SP 4]	LD90	SONG [SP 5]	LD95	SONG [SP 6]	LD100	SONG [SP 7]	LD105	SONG [SP 8]	LD110	SONG [SP 9]	LD115	SONG [SP 10]	LD120	SONG [SP 11]	LD125	SONG [SP 12]	LD130	SONG [SP 13]	LD135	SONG [SP 14]	LD140	SONG [SP 15]	LD145	SONG [SP 16]	LD150	SONG [SP 17]	LD155	SONG [SP 18]	LD160	SONG [SP 19]	LD165	SONG [SP 20]	LD170	SONG [SP 21]	LD175	SONG [SP 22]	LD180	SONG [SP 23]	LD185	SONG [SP 24]	LD190	SONG [SP 25]	LD195	SONG [SP 26]	LD200	SONG [SP 27]	LD205	SONG [SP 28]	LD210	SONG [SP 29]	LD215	SONG [SP 30]	LD220	SONG [SP 31]	LD225	SONG [SP 32]	LD230	SONG [SP 33]	LD235	SONG [SP 34]	LD240	SONG [SP 35]	LD245	SONG [SP 36]	LD250	SONG [SP 37]	LD255	SONG [SP 38]	LD260	SONG [SP 39]	LD265	SONG [SP 40]	LD270	SONG [SP 41]	LD275	SONG [SP 42]	LD280	SONG [SP 43]	LD285	SONG [SP 44]	LD290	SONG [SP 45]	LD295	SONG [SP 46]	LD300	SONG [SP 47]	LD305	SONG [SP 48]	LD310	SONG [SP 49]	LD315	SONG [SP 50]	LD320	SONG [SP 51]	LD325	SONG [SP 52]	LD330	SONG [SP 53]	LD335	SONG [SP 54]	LD340	SONG [SP 55]	LD345	SONG [SP 56]	LD350	SONG [SP 57]	LD355	SONG [SP 58]	LD360	SONG [SP 59]	LD365	SONG [SP 60]	LD370	SONG [SP 61]	LD375	SONG [SP 62]	LD380	SONG [SP 63]	LD385	SONG [SP 64]	LD390	SONG [SP 65]	LD395	SONG [SP 66]	LD400	SONG [SP 67]	LD405	SONG [SP 68]	LD410	SONG [SP 69]	LD415	SONG [SP 70]	LD420	SONG [SP 71]	LD425	SONG [SP 72]	LD430	SONG [SP 73]	LD435	SONG [SP 74]	LD440	SONG [SP 75]	LD445	SONG [SP 76]	LD450	SONG [SP 77]	LD455	SONG [SP 78]	LD460	SONG [SP 79]	LD465	SONG [SP 80]	LD470	SONG [SP 81]	LD475	SONG [SP 82]	LD480	SONG [SP 83]	LD485	SONG [SP 84]	LD490	SONG [SP 85]	LD495	SONG [SP 86]	LD500	SONG [SP 87]	LD505	SONG [SP 88]	LD510	SONG [SP 89]	LD515	SONG [SP 90]	LD520	SONG [SP 91]	LD525	SONG [SP 92]	LD530	SONG [SP 93]	LD535	SONG [SP 94]	LD540	SONG [SP 95]	LD545	SONG [SP 96]	LD550	SONG [SP 97]	LD555	SONG [SP 98]	LD560	SONG [SP 99]	LD565	SONG [SP 100]
-----	--------------------	------	------------	------	----------	------	-----------	------	------------	------	-----------	------	-------------	------	-------------	------	-------------	------	-------------	------	-------------	------	-------------	-------	-------------	-------	-------------	-------	-------------	-------	--------------	-------	--------------	-------	--------------	-------	--------------	-------	--------------	-------	--------------	-------	--------------	-------	--------------	-------	--------------	-------	--------------	-------	--------------	-------	--------------	-------	--------------	-------	--------------	-------	--------------	-------	--------------	-------	--------------	-------	--------------	-------	--------------	-------	--------------	-------	--------------	-------	--------------	-------	--------------	-------	--------------	-------	--------------	-------	--------------	-------	--------------	-------	--------------	-------	--------------	-------	--------------	-------	--------------	-------	--------------	-------	--------------	-------	--------------	-------	--------------	-------	--------------	-------	--------------	-------	--------------	-------	--------------	-------	--------------	-------	--------------	-------	--------------	-------	--------------	-------	--------------	-------	--------------	-------	--------------	-------	--------------	-------	--------------	-------	--------------	-------	--------------	-------	--------------	-------	--------------	-------	--------------	-------	--------------	-------	--------------	-------	--------------	-------	--------------	-------	--------------	-------	--------------	-------	--------------	-------	--------------	-------	--------------	-------	--------------	-------	--------------	-------	--------------	-------	--------------	-------	--------------	-------	--------------	-------	--------------	-------	--------------	-------	--------------	-------	--------------	-------	--------------	-------	--------------	-------	--------------	-------	--------------	-------	--------------	-------	--------------	-------	--------------	-------	--------------	-------	--------------	-------	--------------	-------	--------------	-------	--------------	-------	--------------	-------	--------------	-------	--------------	-------	--------------	-------	--------------	-------	--------------	-------	---------------

LED MATRIX (PNL)

LC0	VSSLA	LC14	VSSLA	LC28	VSSLA	LC42	VSSLA	LC56	VSSLA	LC70	VSSLA	LC84	VSSLA	LC98	VSSLA	LC112	VSSLA	LC126	VSSLA	LC140	VSSLA	LC154	VSSLA	LC168	VSSLA	LC182	VSSLA	LC196	VSSLA	LC210	VSSLA	LC224	VSSLA	LC238	VSSLA	LC252	VSSLA	LC266	VSSLA	LC280	VSSLA	LC294	VSSLA	LC308	VSSLA	LC322	VSSLA	LC336	VSSLA	LC350	VSSLA	LC364	VSSLA	LC378	VSSLA	LC392	VSSLA	LC406	VSSLA	LC420	VSSLA	LC434	VSSLA	LC448	VSSLA	LC462	VSSLA	LC476	VSSLA	LC490	VSSLA	LC504	VSSLA	LC518	VSSLA	LC532	VSSLA	LC546	VSSLA	LC560	VSSLA	LC574	VSSLA	LC588	VSSLA	LC602	VSSLA	LC616	VSSLA	LC630	VSSLA	LC644	VSSLA	LC658	VSSLA	LC672	VSSLA	LC686	VSSLA	LC700	VSSLA	LC714	VSSLA	LC728	VSSLA	LC742	VSSLA	LC756	VSSLA	LC770	VSSLA	LC784	VSSLA	LC798	VSSLA	LC812	VSSLA	LC826	VSSLA	LC840	VSSLA	LC854	VSSLA	LC868	VSSLA	LC882	VSSLA	LC896	VSSLA	LC910	VSSLA	LC924	VSSLA	LC938	VSSLA	LC952	VSSLA	LC966	VSSLA	LC980	VSSLA	LC994	VSSLA	LC1008	VSSLA
-----	-------	------	-------	------	-------	------	-------	------	-------	------	-------	------	-------	------	-------	-------	-------	-------	-------	-------	-------	-------	-------	-------	-------	-------	-------	-------	-------	-------	-------	-------	-------	-------	-------	-------	-------	-------	-------	-------	-------	-------	-------	-------	-------	-------	-------	-------	-------	-------	-------	-------	-------	-------	-------	-------	-------	-------	-------	-------	-------	-------	-------	-------	-------	-------	-------	-------	-------	-------	-------	-------	-------	-------	-------	-------	-------	-------	-------	-------	-------	-------	-------	-------	-------	-------	-------	-------	-------	-------	-------	-------	-------	-------	-------	-------	-------	-------	-------	-------	-------	-------	-------	-------	-------	-------	-------	-------	-------	-------	-------	-------	-------	-------	-------	-------	-------	-------	-------	-------	-------	-------	-------	-------	-------	-------	-------	-------	-------	-------	-------	-------	-------	-------	-------	-------	-------	-------	-------	-------	-------	-------	-------	--------	-------

Note : See parts list for details of circuit board component parts.

Tyros3 OVERALL CIRCUIT DIAGRAM 9/9 (PNC, PNR, EN)



• SWITCH MATRIX (PNC)

	DA[0]	DA[1]	DA[2]	DA[3]	DA[4]
SA[11]	SW1 (1)(Δ)	SW2 (2)(Δ)	SW3 (3)(Δ)	SW4 (4)(Δ)	SW5 (5)(Δ)
SA[12]	SW6 (1)(▽)	SW7 (2)(▽)	SW8 (3)(▽)	SW9 (4)(▽)	SW10 (5)(▽)
SA[13]	SW11 (6)(Δ)	SW12 (7)(Δ)	SW13 (8)(Δ)	SW14 (9)(Δ)	SW15 (10)(Δ)
SA[14]	SW16 (6)(▽)	SW17 (7)(▽)	SW18 (8)(▽)	SW19 (9)(▽)	SW20 (10)(▽)

• SWITCH MATRIX (PNR)

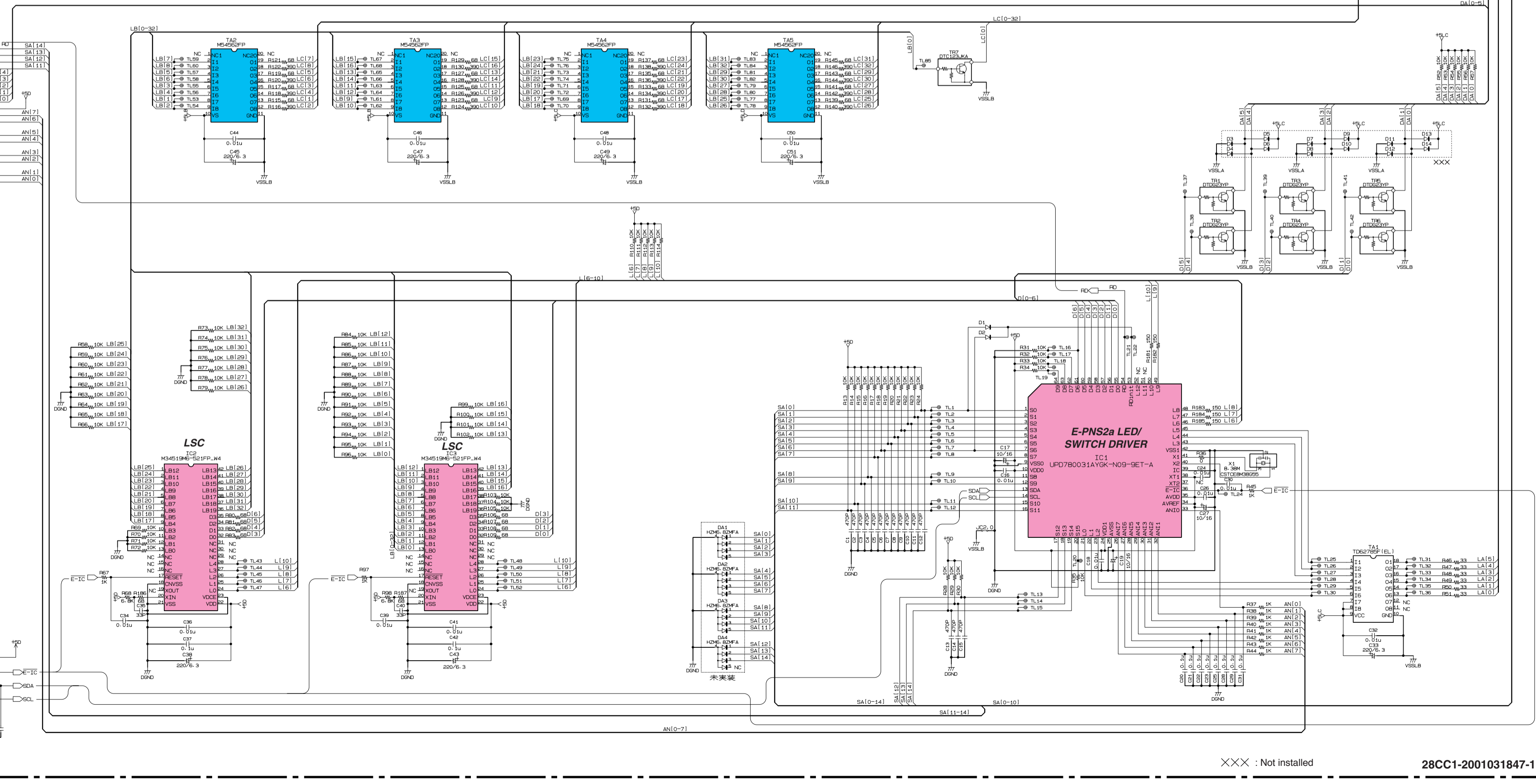
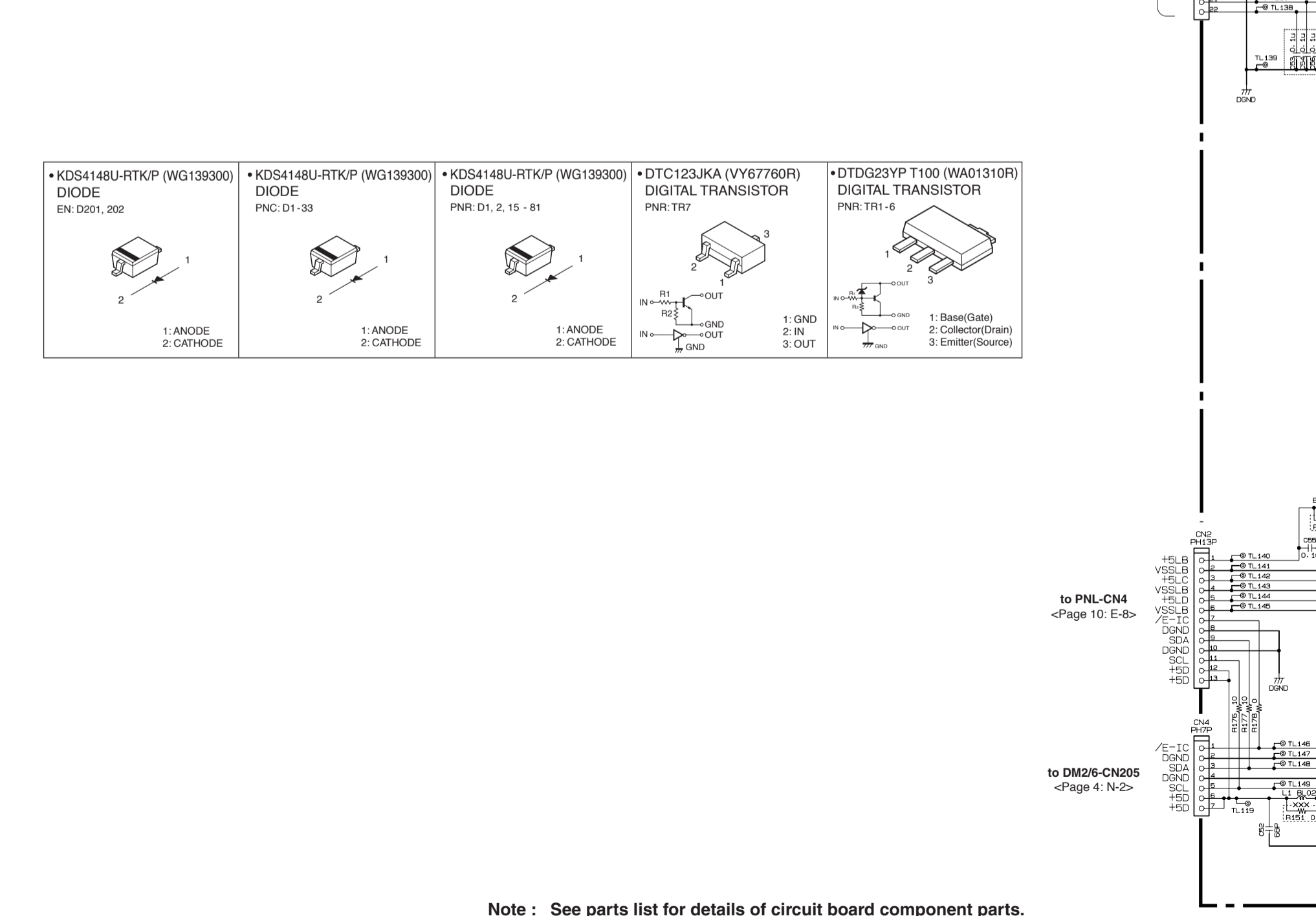
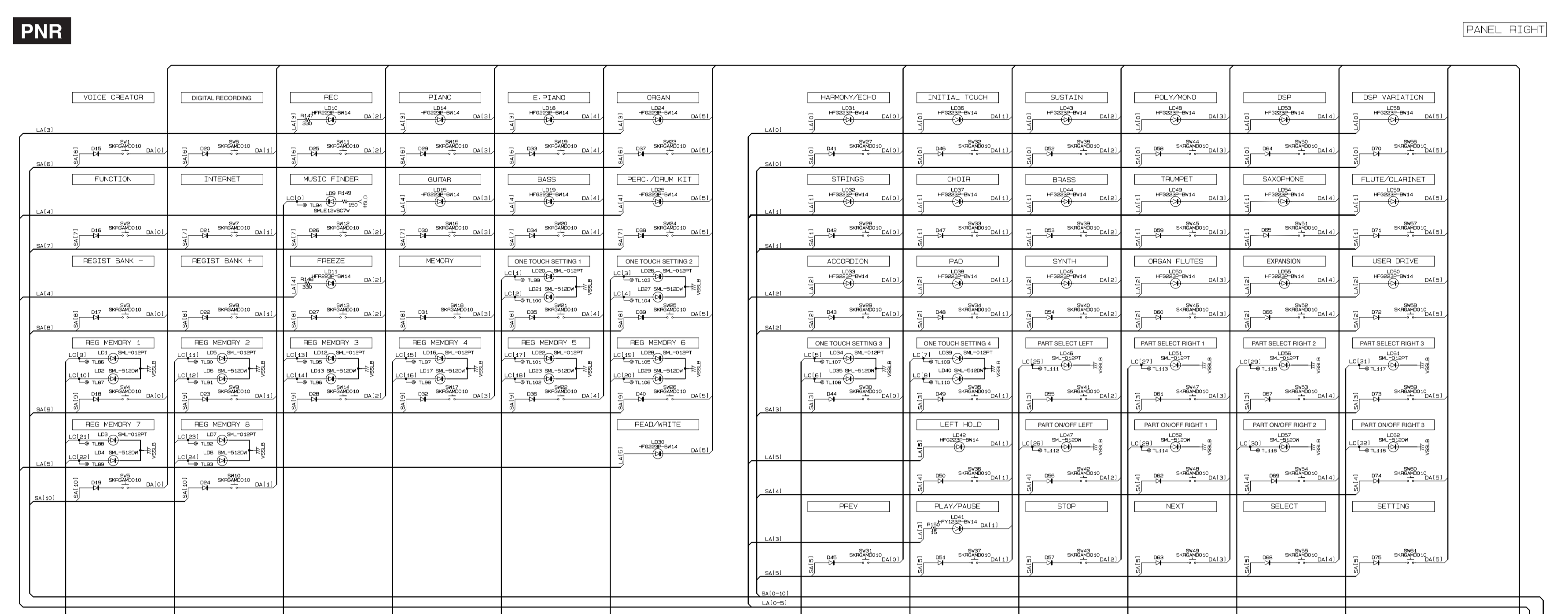
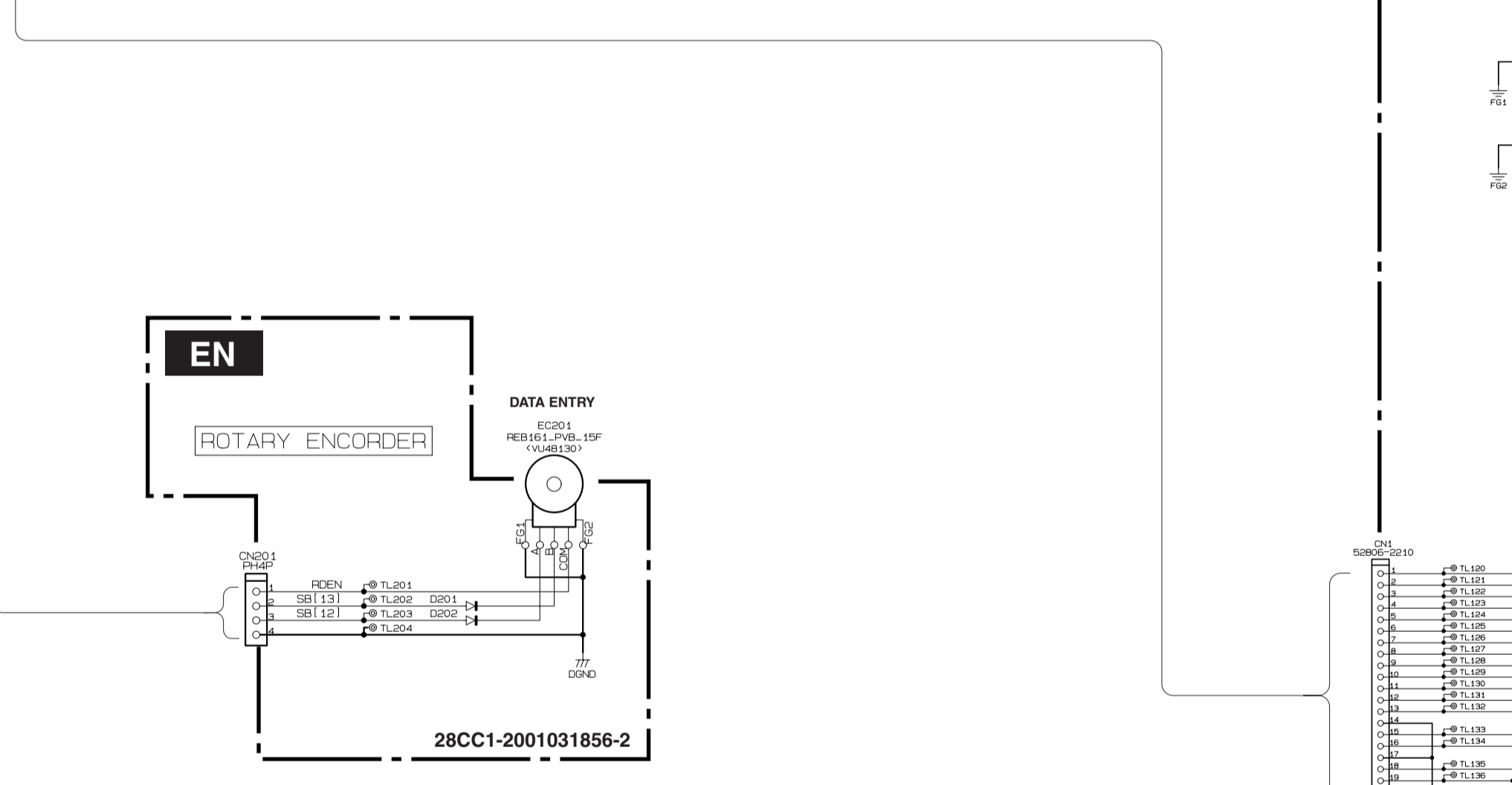
	DA[0]	DA[1]	DA[2]	DA[3]	DA[4]	DA[5]
SA[0]	SW21 VOICE EFFECT (HARMONY/ECHO)	SW22 VOICE EFFECT (INITIAL TOUCH)	SW23 VOICE EFFECT (SUSTAIN)	SW24 VOICE EFFECT (MONO)	SW25 VOICE EFFECT (DSP)	SW26 VOICE EFFECT (VARIATION)
SA[1]	SW27 VOICE (STRINGS)	SW28 VOICE (CHOIR)	SW29 VOICE (BRASS)	SW30 VOICE (TRUMPET)	SW31 VOICE (SAXOPHONE)	SW32 VOICE (FLUTE/CLARINET)
SA[2]	SW33 VOICE (ACCORDION)	SW34 VOICE (PAD)	SW35 VOICE (SYNTH)	SW36 VOICE (ORGAN FLUTES)	SW37 VOICE (EXPANSION)	SW38 VOICE (USER DRIVE)
SA[3]	SW39 ONE TOUCH SETTING (3)	SW40 ONE TOUCH SETTING (4)	SW41 PART SELECT (LEFT)	SW42 PART SELECT (RIGHT 1)	SW43 PART SELECT (RIGHT 2)	SW44 PART SELECT (RIGHT 3)
SA[4]	SW45 HARD DISK RECORDER (PREV)	SW46 HARD DISK RECORDER (PLAY/PAUSE)	SW47 HARD DISK RECORDER (STOP)	SW48 HARD DISK RECORDER (NEXT)	SW49 HARD DISK RECORDER (SELECT)	SW50 HARD DISK RECORDER (SETTING)
SA[5]	SW51 MENU (VOICE CREATOR)	SW52 MENU (DIGITAL RECORDING)	SW53 HARD DISK RECORDER (REC)	SW54 VOICE (PIANO)	SW55 VOICE (E.PIANO)	SW56 VOICE (ORGAN)
SA[6]	SW57 MENU (FUNCTION)	SW58 INTERNET	SW59 MUSIC FINDER	SW60 VOICE (GUITAR)	SW61 VOICE (BASS)	SW62 VOICE (PERC./DRUM KIT)
SA[7]	SW63 REGIST BANK (-)	SW64 REGIST BANK (+)	SW65 REGISTRATION MEMORY (FREEZE)	SW66 REGISTRATION MEMORY (MEMORY)	SW67 ONE TOUCH SETTING (1)	SW68 ONE TOUCH SETTING (2)
SA[8]	SW69 REGISTRATION MEMORY (1)	SW70 REGISTRATION MEMORY (2)	SW71 REGISTRATION MEMORY (3)	SW72 REGISTRATION MEMORY (4)	SW73 REGISTRATION MEMORY (5)	SW74 REGISTRATION MEMORY (6)
SA[9]	SW75 REGISTRATION MEMORY (7)	SW76 REGISTRATION MEMORY (8)	SW77 REGISTRATION MEMORY (9)	SW78 REGISTRATION MEMORY (10)	SW79 REGISTRATION MEMORY (11)	SW80 REGISTRATION MEMORY (12)
SA[10]	SW81 REGISTRATION MEMORY (13)	SW82 REGISTRATION MEMORY (14)	SW83 REGISTRATION MEMORY (15)	SW84 REGISTRATION MEMORY (16)	SW85 REGISTRATION MEMORY (17)	SW86 REGISTRATION MEMORY (18)

• LED MATRIX (PNC)

	VSSD	VSSD	VSSD	VSSD	VSSD	VSSD
LC[0]	LD1 MUSIC FINDER	LD2	LD3	LD4 REGISTRATION MEMORY (2)	LD5 REGISTRATION MEMORY (3)	LD6 REGISTRATION MEMORY (4)
LC[1]	LD7 ONE TOUCH SETTING (1)	LD8 ONE TOUCH SETTING (2)	LD9 ONE TOUCH SETTING (3)	LD10 REGISTRATION MEMORY (5)	LD11 REGISTRATION MEMORY (6)	LD12 REGISTRATION MEMORY (7)
LC[2]	LD13 ONE TOUCH SETTING (4)	LD14 ONE TOUCH SETTING (5)	LD15 ONE TOUCH SETTING (6)	LD16 REGISTRATION MEMORY (8)	LD17 REGISTRATION MEMORY (9)	LD18 REGISTRATION MEMORY (10)
LC[3]	LD19 ONE TOUCH SETTING (7)	LD20 ONE TOUCH SETTING (8)	LD21 ONE TOUCH SETTING (9)	LD22 REGISTRATION MEMORY (11)	LD23 REGISTRATION MEMORY (12)	LD24 REGISTRATION MEMORY (13)
LC[4]	LD25 ONE TOUCH SETTING (10)	LD26 ONE TOUCH SETTING (11)	LD27 ONE TOUCH SETTING (12)	LD28 REGISTRATION MEMORY (14)	LD29 REGISTRATION MEMORY (15)	LD30 REGISTRATION MEMORY (16)
LC[5]	LD31 ONE TOUCH SETTING (13)	LD32 ONE TOUCH SETTING (14)	LD33 ONE TOUCH SETTING (15)	LD34 REGISTRATION MEMORY (17)	LD35 REGISTRATION MEMORY (18)	LD36 REGISTRATION MEMORY (19)
LC[6]	LD37 ONE TOUCH SETTING (16)	LD38 ONE TOUCH SETTING (17)	LD39 ONE TOUCH SETTING (18)	LD40 REGISTRATION MEMORY (20)	LD41 REGISTRATION MEMORY (21)	LD42 REGISTRATION MEMORY (22)
LC[7]	LD43 ONE TOUCH SETTING (19)	LD44 ONE TOUCH SETTING (20)	LD45 ONE TOUCH SETTING (21)	LD46 REGISTRATION MEMORY (23)	LD47 REGISTRATION MEMORY (24)	LD48 REGISTRATION MEMORY (25)
LC[8]	LD49 ONE TOUCH SETTING (22)	LD50 ONE TOUCH SETTING (23)	LD51 ONE TOUCH SETTING (24)	LD52 REGISTRATION MEMORY (26)	LD53 REGISTRATION MEMORY (27)	LD54 REGISTRATION MEMORY (28)
LC[9]	LD55 ONE TOUCH SETTING (25)	LD56 ONE TOUCH SETTING (26)	LD57 ONE TOUCH SETTING (27)	LD58 REGISTRATION MEMORY (29)	LD59 REGISTRATION MEMORY (30)	LD60 REGISTRATION MEMORY (31)
LC[10]	LD61 ONE TOUCH SETTING (28)	LD62 ONE TOUCH SETTING (29)	LD63 ONE TOUCH SETTING (30)	LD64 REGISTRATION MEMORY (32)	LD65 REGISTRATION MEMORY (33)	LD66 REGISTRATION MEMORY (34)

• LED MATRIX (PNR)

	DA[0]	DA[1]	DA[2]	DA[3]	DA[4]	DA[5]
LA[0]	LD67 VOICE EFFECT (HARMONY/ECHO)	LD68 VOICE EFFECT (INITIAL TOUCH)	LD69 VOICE EFFECT (SUSTAIN)	LD70 VOICE EFFECT (MONO)	LD71 VOICE EFFECT (DSP)	LD72 VOICE EFFECT (VARIATION)
LA[1]	LD73 VOICE (STRINGS)	LD74 VOICE (CHOIR)	LD75 VOICE (BRASS)	LD76 VOICE (TRUMPET)	LD77 VOICE (SAXOPHONE)	LD78 VOICE (FLUTE/CLARINET)
LA[2]	LD79 VOICE (ACCORDION)	LD80 VOICE (PAD)	LD81 VOICE (SYNTH)	LD82 VOICE (ORGAN FLUTES)	LD83 VOICE (EXPANSION)	LD84 VOICE (USER DRIVE)
LA[3]	LD85 HARD DISK RECORDER (PREV)	LD86 HARD DISK RECORDER (PLAY/PAUSE)	LD87 HARD DISK RECORDER (REC)	LD88 VOICE (PIANO)	LD89 VOICE (E.PIANO)	LD90 VOICE (ORGAN)
LA[4]	LD91 HARD DISK RECORDER (NEXT)	LD92 HARD DISK RECORDER (SELECT)	LD93 HARD DISK RECORDER (SETTING)	LD94 VOICE (GUITAR)	LD95 VOICE (BASS)	LD96 VOICE (PERC./DRUM KIT)
LA[5]	LD97 PART ON/OFF (LEFT HOLD)	LD98 PART ON/OFF (RIGHT 1)	LD99 PART ON/OFF (RIGHT 2)	LD100 PART ON/OFF (RIGHT 3)	LD101 PART ON/OFF (RIGHT 4)	LD102 PART ON/OFF (RIGHT 5)



- KDS4148U-RTK/P (WG139300) DIODE EN: D201, 202
- KDS4148U-RTK/P (WG139300) DIODE PNC: D1-33
- KDS4148U-RTK/P (WG139300) DIODE PNR: D1, 2, 15-81
- DTC123JKA (YV67760R) DIGITAL TRANSISTOR PNC: TR1
- DTDG25YP T100 (WA01310R) DIGITAL TRANSISTOR PNR: TR1-4

Note : See parts list for details of circuit board component parts.

XXX : Not installed 28CC1-2001031847-1